

**Honeywell**

**2020/3820/3820i**

---

Cordless System

**User's Guide**

---

## **Disclaimer**

Honeywell International Inc. ("Honeywell") reserves the right to make changes in specifications and other information contained in this document without prior notice, and the reader should in all cases consult Honeywell to determine whether any such changes have been made. The information in this publication does not represent a commitment on the part of Honeywell.

Honeywell shall not be liable for technical or editorial errors or omissions contained herein; nor for incidental or consequential damages resulting from the furnishing, performance, or use of this material.

This document contains proprietary information that is protected by copyright. All rights are reserved. No part of this document may be photocopied, reproduced, or translated into another language without the prior written consent of Honeywell.

© 2004-2008 Honeywell International Inc. All rights reserved.

Other product names or marks mentioned in this document may be trademarks or registered trademarks of other companies and are the property of their respective owners.

Web Address: [www.honeywell.com/aidcww](http://www.honeywell.com/aidcww)

Microsoft® Pocket PC 2002, Windows®, Windows NT®, Windows 2000, Windows ME, Windows XP, ActiveSync®, Outlook®, and the Windows logo are trademarks or registered trademarks of Microsoft Corporation.

The *Bluetooth*® word mark and logos are owned by Bluetooth SIG, Inc.

---

---

## ***Product Agency Compliance***

### ***USA***

#### ***FCC Part 15 Subpart C***

This device complies with part 15 of the FCC Rules. Operation is subject to the following two conditions:

1. This device may not cause harmful interference.
2. This device must accept any interference received, including interference that may cause undesired operation.

Caution: Any changes or modifications made to this equipment not expressly approved by Honeywell may void the FCC authorization to operate this equipment.



UL listed: UL60950-1 for I.T.E product safety.

### ***Canada***

#### ***Industry Canada***

This device complies with Canadian RSS-210.

Operation is subject to the following conditions:

1. This device may not cause interference, and
2. This device must accept any interference, including interference that may cause undesired operation of this device.

#### ***Conformité à la réglementation canadienne***

Cet appareil ISM est conforme à la norme CNR-210 du Canada.

Son fonctionnement est assujéti aux conditions suivantes :

1. Cet appareil ne doit pas causer de brouillage préjudiciable.
  2. Cet appareil doit pouvoir accepter tout brouillage reçu, y compris le brouillage pouvant causer un fonctionnement indésirable.
-



cUL listed: CSA C22.2 No.60950-1-03 for I.T.E product safety.

## **Europe**

**CE** The CE marking on the product indicates that this device is in conformity with all essential requirements of the 1999/5/EC R&TTE Directive. In addition, complies to 2006/95/EC Low Voltage Directive, when shipped with recommended power supply.

For CE-related inquiries, please contact:  
Honeywell Imaging & Mobility Europe BV  
International Inc.  
Nijverheidsweg 9-13  
5627 BT Eindhoven  
The Netherlands

Honeywell shall not be liable for use of our product with equipment (i.e., power supplies, personal computers, etc.) that is not CE marked and does not comply with the Low Voltage Directive. This equipment is intended for use throughout the European Community and has been assessed to the following standards:

EN 300 328

EN 301 489-1

EN 301 489-17

EN60950-1

EN60825-1

## **Waste Electrical and Electronic Equipment Information**

Honeywell complies with Directive 2002/96/EC OF THE EUROPEAN PARLIAMENT AND OF THE COUNCIL on waste electrical and electronic equipment (WEEE).

This product has required the extraction and use of natural resources for its production. It may contain hazardous substances that could impact health and the environment, if not properly disposed.

In order to avoid the dissemination of those substances in our environment and to diminish the pressure on the natural resources, we encourage you to use the appropriate take-back systems for product disposal. Those systems will reuse or recycle most of the materials of the product you are disposing in a sound way.



The crossed out wheeled bin symbol informs you that the product should not be disposed of along with municipal waste and invites you to use the appropriate separate take-back systems for product disposal.

---

---

If you need more information on the collection, reuse, and recycling systems, please contact your local or regional waste administration.

You may also contact your supplier for more information on the environmental performances of this product.

## **Germany**



If your product is marked with the GS symbol, then the product has been issued a GS certificate showing compliance to IEC 60950-1 and IEC 60825-1.

## **Australia/NZ**

### **C-Tick Statement**



Conforms to AS/NZS 3548 EMC requirements.

## **Japan (2020-5B)**

Complies with Technical Regulations Conformity Certification of Specified Radio equipment.

## **Mexico**



Applicable if NOM logo is marked on product. Conforms to NOM-019.

Comision Federal de Telecomunicaciones (radio aprobaci3n)

## **International**



**CAUTION: RISK OF EXPLOSION IF BATTERY IS REPLACED BY AN INCORRECT TYPE.** The battery should be disposed of by a qualified recycler or hazardous materials handler. Do not incinerate the battery or dispose of the battery with general waste materials.

---

---

## ***Eye Safety Statement (LED)***

This device has been tested in accordance with IEC60825-1 LED safety, and has been certified to be a Class 1 LED device.

## ***Radio Technology***



## ***CB Scheme***

Certified to CB Scheme IEC 60950-1.

## ***Solids and Water Protection***

The 3820 has a rating of IP41, immunity of foreign particles and dripping water.

The 3820i has a rating of IP54, immunity of foreign particles and sprayed water.

## ***Patents***

Please refer to product packaging for patent information.

---

## ***Required Safety Labels***

### **Scanner**

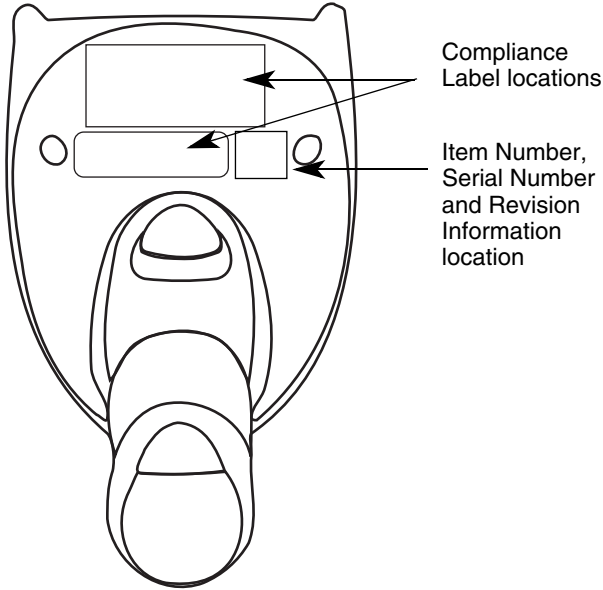

---

**Base**

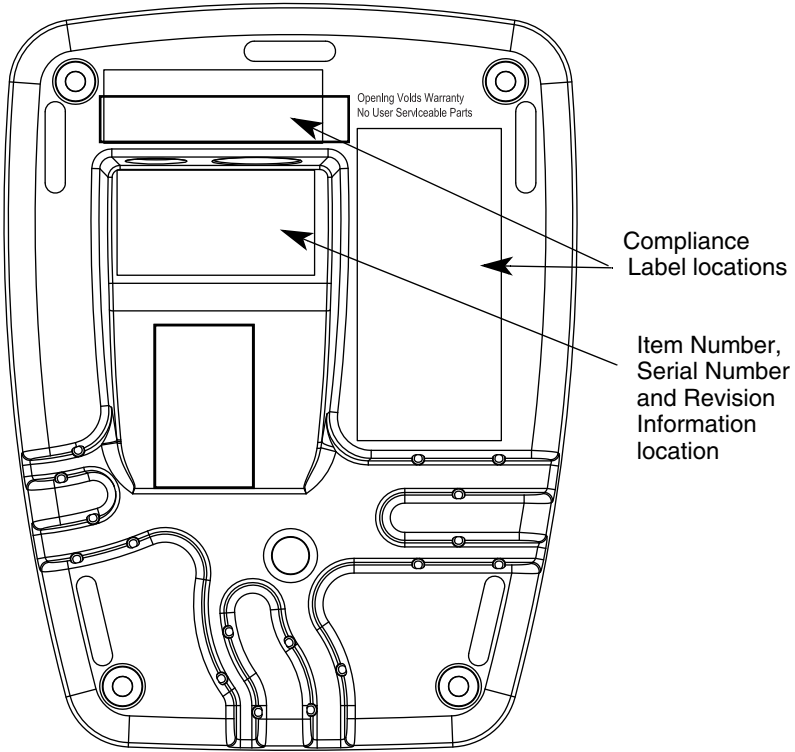





# **Table of Contents**

## **Chapter 1 - Getting Started**

About This Manual .....	1-1
Unpacking the System .....	1-1
Models.....	1-1
Cordless System: Main Components .....	1-2
About the Battery .....	1-2
Proper Disposal of the Battery .....	1-3
Base Charge Mode .....	1-4
Linking Image Scanner to Base .....	1-5
Image Scanner Modes .....	1-5
Unlinking the Image Scanner .....	1-5
Single Image Scanner Operation .....	1-6
Locked Link Mode - Single Image Scanner.....	1-6
Open Link Mode - Single Image Scanner .....	1-6
Override Locked Image Scanner.....	1-6
Multiple Image Scanner Operation.....	1-7
Image Scanner Name .....	1-7
Changing Image Scanner Name - Serially .....	1-7
Changing Image Scanner Name - via Barcodes ...	1-8
Image Scanner Report .....	1-9
Application Work Groups .....	1-9
Application Work Group Selection.....	1-10
Resetting the Standard Product Default Settings:	
Current Application Work Group .....	1-11
Resetting the Standard Product Default Settings:	
All Application Work Groups .....	1-11
Using the Image Scanner with Bluetooth Devices ...	1-12
Changing Bluetooth PIN Code .....	1-12
Out-of-Range Alarm .....	1-12
Duration.....	1-12
Alarm Sound Type.....	1-13
Data Accumulation Mode .....	1-13
Batch Mode Transmit Delay .....	1-14

---

Beeper and LED Sequences and Their Meaning .....	1-14
3820/3820i LED Sequences and Their Meaning .	1-15
2020 LED Sequences and Their Meaning .....	1-15
Basic Operation of the Cordless System .....	1-16
System Conditions .....	1-17
Communication Between the Cordless System and the Host .....	1-18
Connecting the Base When Powered by Host (Keyboard Wedge) .....	1-18
Reading Techniques .....	1-20
Resetting the Standard Product Defaults .....	1-20
Plug and Play .....	1-21
Keyboard Wedge Connection .....	1-21
Laptop Direct Connect .....	1-21
RS-232 .....	1-21
Wand Emulation Plug & Play .....	1-22
IBM 4683 Ports 5B, 9B, and 17 Interface .....	1-22
Connecting the Base with USB .....	1-23
IBM SurePos .....	1-24
USB PC or Macintosh Keyboard .....	1-24
USB HID .....	1-25
USB Com Port Emulation .....	1-25
Connecting the Base with Serial Wedge .....	1-26

## ***Chapter 2 - Terminal Interfaces***

Terminal ID .....	2-1
Supported Terminals .....	2-2
Keyboard Country .....	2-4
Keyboard Style .....	2-6
Keyboard Modifiers .....	2-7

---

Connecting the Base with RS-232 Serial Port .....	2-8
RS-232 Baud Rate .....	2-9
RS-232 Word Length: Data Bits, Stop Bits, and Parity .....	2-10
RS-232 Handshaking .....	2-10
Host ACK Selection .....	2-11
Host ACK Enable .....	2-12
Wand Emulation .....	2-14
Wand Emulation Connection .....	2-14
Wand Emulation Transmission Rate .....	2-15
Wand Emulation Polarity .....	2-15
Wand Emulation Idle .....	2-15
Wand Emulation Data Block Size .....	2-16
Wand Emulation Delay Between Blocks .....	2-16
Wand Emulation Overall Checksum .....	2-16

### **Chapter 3 - Output**

Good Read Indicators .....	3-1
Beeper – Good Read .....	3-1
Beeper Volume – Good Read .....	3-1
Beeper Pitch – Good Read .....	3-2
Beeper Duration – Good Read .....	3-2
LED – Good Read .....	3-2
Number of Beeps – Good Read .....	3-2
Good Read Delay .....	3-3
User-Specified Good Read Delay .....	3-3
Image Scanner Trigger Modes .....	3-3
Manual/Serial Trigger, Low Power .....	3-3
Automatic Trigger .....	3-5
Presentation Mode .....	3-5
Hands Free Time-Out .....	3-6
Reread Delay .....	3-6
User-Specified Reread Delay .....	3-6
Centering Window .....	3-7
Preferred Symbology .....	3-8

---

Output Sequence Overview .....	3-10
Output Sequence Editor .....	3-11
Require Output Sequence .....	3-11
Multiple Symbols.....	3-13
No Read.....	3-14
Video Reverse .....	3-14

## **Chapter 4 - Data Editing**

Prefix/Suffix Overview.....	4-1
To Add a Prefix or Suffix: .....	4-1
To Clear One or All Prefixes or Suffixes: .....	4-2
To Add a Carriage Return Suffix to All Symbologies .....	4-3
Prefix Selections .....	4-3
Suffix Selections .....	4-4
Function Code Transmit .....	4-4
Intercharacter, Interfunction, and Intermessage Delays.....	4-4
Intercharacter Delay .....	4-5
User Specified Intercharacter Delay .....	4-5
Interfunction Delay .....	4-6
Intermessage Delay .....	4-6

## **Chapter 5 - Data Formatting**

Data Format Editor Introduction.....	5-1
To Add a Data Format .....	5-1
Other Programming Selections.....	5-2
Data Format Editor Commands .....	5-2
Data Format Editor .....	5-4
Data Formatter.....	5-4
Alternate Data Formats.....	5-5

## **Chapter 6 - Symbologies**

Introduction .....	6-1
All Symbologies .....	6-1

---

Message Length.....	6-2
Codabar .....	6-3
Codabar Start/Stop Characters .....	6-3
Codabar Check Character.....	6-3
Codabar Concatenation .....	6-4
Codabar Message Length .....	6-5
Code 39.....	6-5
Code 39 Start/Stop Characters.....	6-5
Code 39 Check Character.....	6-6
Code 39 Message Length .....	6-6
Code 39 Append .....	6-7
Code 32 Pharmaceutical (PARAF).....	6-7
Full ASCII .....	6-8
Code 39 Code Page.....	6-9
Interleaved 2 of 5 .....	6-9
Check Digit.....	6-9
Interleaved 2 of 5 Message Length .....	6-10
Code 93.....	6-11
Code 93 Message Length .....	6-11
Code 93 Code Page.....	6-11
Straight 2 of 5 Industrial .....	6-12
Straight 2 of 5 Industrial Message Length.....	6-12
Straight 2 of 5 IATA Message Length .....	6-13
Matrix 2 of 5 .....	6-13
Matrix 2 of 5 Message Length .....	6-14
Code 11.....	6-14
Check Digits Required.....	6-14
Code 11 Message Length .....	6-15
Code 128.....	6-15
ISBT 128 Concatenation .....	6-16
Code 128 Message Length .....	6-16
Code 128 Code Page.....	6-16
Code 128 Function Code Transmit .....	6-17
Telepen .....	6-17
Telepen Output.....	6-17
Telepen Message Length.....	6-18

---

UPC A .....	6-18
UPC A Check Digit .....	6-18
UPC A Number System .....	6-19
UPC A Addenda .....	6-19
UPC A Addenda Required .....	6-19
UPC A Addenda Separator .....	6-20
UPC-A/EAN-13 with Extended Coupon Code .....	6-20
UPC E0 and UPC E1 .....	6-21
UPC E0 and UPC E1 Expand .....	6-21
UPC E0 and UPC E1 Addenda Required .....	6-21
UPC E0 and UPC E1 Addenda Separator .....	6-22
UPC E0 Check Digit .....	6-22
UPC E0 Number System .....	6-22
UPC E0 Addenda .....	6-23
EAN/JAN 13 .....	6-23
EAN/JAN 13 Check Digit .....	6-23
EAN/JAN 13 Addenda .....	6-24
EAN/JAN 13 Addenda Required .....	6-24
EAN/JAN 13 Addenda Separator .....	6-24
ISBN Translate .....	6-25
EAN/JAN 8 .....	6-25
EAN/JAN 8 Check Digit .....	6-25
EAN/JAN 8 Addenda .....	6-26
EAN/JAN 8 Addenda Required .....	6-26
EAN/JAN 8 Addenda Separator .....	6-26
MSI .....	6-27
MSI Check Character .....	6-27
MSI Message Length .....	6-27
Plessey Code .....	6-28
Plessey Message Length .....	6-28
GS1 DataBar Omnidirectional .....	6-29
GS1 DataBar Limited .....	6-29
GS1 DataBar Expanded .....	6-30
GS1 DataBar Expanded Message Length .....	6-30
GS1 Emulation .....	6-30
China Post Code .....	6-31

---

Korea Post Code .....	6-32
Korea Post Message Length .....	6-32
PosiCode A and B .....	6-32
PosiCode Message Length .....	6-33
Trioptic Code .....	6-33
Codablock F .....	6-34
Codablock F Message Length.....	6-34
Code 16K .....	6-35
Code 16K Message Length.....	6-35
Code 49.....	6-35
Code 49 Message Length .....	6-36

## ***Chapter 7 - Interface Keys***

Keyboard Function Relationships .....	7-1
---------------------------------------	-----

## ***Chapter 8 - Utilities***

To Add a Test Code I.D. Prefix to All Symbologies.....	8-1
Reset Image Scanner .....	8-1
Show Software Revision .....	8-1
Show Data Format .....	8-1
Image Scanner Report .....	8-2
Image Scanner Address.....	8-2
Base Address .....	8-2
Resetting the Standard Product Default Settings:	
Current Application Work Group .....	8-2
Resetting the Standard Product Default Settings:	
All Application Work Groups .....	8-3
Temporary Visual Xpress Configuration .....	8-3

## ***Chapter 9 - Visual Xpress***

Visual Xpress Introduction .....	9-1
Installing Visual Xpress from the Web.....	9-2

## ***Chapter 10 - Serial Programming Commands***

Conventions .....	10-1
-------------------	------

---

Menu Command Syntax .....	10-1
Query Commands.....	10-2
Concatenation of Multiple Commands.....	10-2
Responses.....	10-3
Examples of Query Commands.....	10-3
Trigger Commands.....	10-4
Resetting the Standard Product Default Settings:	
Current Application Work Group .....	10-4
Resetting the Standard Product Default Settings:	
All Application Work Groups.....	10-5
Menu Commands .....	10-6
Terminal Interfaces .....	10-7
Output Selections .....	10-11
Prefix/Suffix Selections .....	10-13
Data Formatter Selections .....	10-14
Symbolologies .....	10-14
Minimizing Bluetooth/ISM Band Network Activity .....	10-22

## ***Chapter 11 - Product Specifications***

3820 Product Specifications .....	11-1
3820i Product Specifications .....	11-2
2020-5BE Product Specifications .....	11-3
2020-CBE Product Specifications .....	11-4

## ***Chapter 12 - Maintenance***

Maintenance .....	12-1
Cleaning the Device.....	12-1
Inspecting Cords and Connectors .....	12-1
Replacing the 2020 Interface Cable: .....	12-2
Troubleshooting Base.....	12-2

## ***Chapter 13 - Customer Support***

Technical Assistance.....	13-1
Online Technical Assistance.....	13-1



---

Product Service and Repair .....	13-2
Online Product Service and Repair Assistance...	13-2
Limited Warranty .....	13-3

### ***Appendix A - Reference Charts***

Symbology Chart.....	A-1
ASCII Conversion Chart (Code Page 1252) .....	A-2
Code Page Mapping of Printed Barcodes.....	A-4

### ***Appendix B - Minimizing Bluetooth/ISM Band Network Activity***

Auto Reconnect Mode.....	B-1
Maximum Link Attempts.....	B-2
Relink Time-Out .....	B-3
Bluetooth/ISM Network Activity Examples .....	B-3



# Getting Started

## About This Manual

This manual contains information to help you set up, operate, and program the cordless system. Product specifications, connector pinouts, a troubleshooting guide, and customer support information are also provided.

Honeywell barcode image scanners are factory programmed for the most common terminal and communications settings. If you need to change these settings, programming is accomplished by scanning the barcodes in this guide.

An asterisk (\*) next to an option indicates the default setting.

This section contains the following information:

- Unpacking the System
- Cordless System Main Components
- Battery and Charging Information
- Linking the Image Scanner to the Base
- Beeper and LED Sequences and Their Meaning
- Basic Operation of the Cordless System
- Communication Between the Cordless System and the Host
- Connection of the Base to an Interface

## Unpacking the System

After you open the shipping carton containing the product, take the following steps:

- Check to make sure everything you ordered is present.
- Save the shipping container for later storage or shipping.
- Check for damage during shipment. Report damage immediately to the carrier who delivered the carton.

## Models

Models	Description
2020-5BE	Cordless Base that supports the following interfaces: Keyboard wedge, TTL level 232, TTL level 232 serial wedge, IBM 4683, wand emulation, USB keyboard, USB HID, USB retail (IBM SurePOS)
2020-CBE	Charge-Only Base
3820SR0C0BE	Cordless Linear Image Scanner
3820iSE	Industrial Cordless Linear Image Scanner

---

## **Cordless System: Main Components**

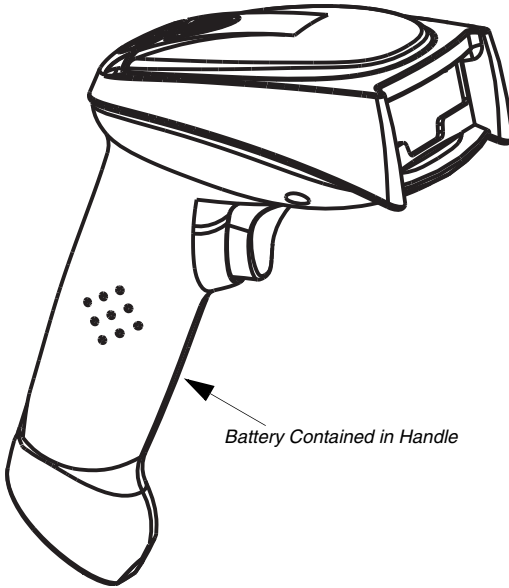

### **About the Battery**



Use only the Li-ion battery packs provided by Honeywell. Use of any battery not sold/manufactured by Honeywell may result in damage not covered by the warranty.

Power is supplied to the cordless image scanner by a rechargeable battery that is integrated in the image scanner handle. Each image scanner is shipped with a battery. (See [Product Specifications](#) beginning on page 11-1.)

### **Charging Information**

The battery is designed to charge while the image scanner is positioned in the cordless base unit. Refer to "[2020 LED Sequences and Their Meaning](#)" on page 1-15 for an interpretation of the Charge Status indicators.

- Place the image scanner in the base that is connected to an appropriate power supply.

---

## **Battery Recommendations**

- Batteries are shipped approximately 30% to 60% charged and should be fully charged for maximum charge capacity.
- The battery is a lithium ion cell and can be used without a full charge, as well as can be charged without fully discharging, without impacting the battery life. There is no need to perform any charge/discharge conditioning on this cell type battery.
- Do not disassemble the battery. There are no user-serviceable parts in the battery.
- Keep the base connected to power when the host is not in use.
- Replace a defective battery immediately since it could damage the 3820/3820i.
- Don't short-circuit a battery or throw it into a fire. It can explode and cause severe personal injury.
- Although your battery can be recharged many times, it will eventually be depleted. Replace it after the battery is unable to hold an adequate charge.
- If you are not sure if the battery or charger is working properly, send it to Honeywell or an authorized Honeywell International Inc. service center for inspection. Refer to [Product Service and Repair](#) on page 13-2 for additional information

## **Proper Disposal of the Battery**



When the battery has reached the end of its useful life, the battery should be disposed of by a qualified recycler or hazardous materials handler. Do not incinerate the battery or dispose of the battery with general waste materials. You may send batteries to Honeywell (postage paid). The shipper is responsible for complying with all federal, state, and local laws and regulations related to the packing, labeling, manifesting, and shipping of spent batteries. Contact the Product Service Department (see 13-1) for recycling or disposal information. Since you may find that your cost of returning the batteries significant, it may be more cost effective to locate a local recycle/disposal company.

---

## Base Charge Mode

In order for the battery to be charged, there must be enough voltage for the circuitry to work. There are three conditions during which power can be supplied to the base:

Condition 1:9VDC power supply connected to the barrel connector

Condition 2:12VDC host power source only

Condition 3:5VDC host power source only

The chart below describes each selection by condition.

	Condition 1	Condition 2	Condition 3
Automatic	Fast Charge	Slow Charge	No Charge
Full Charge Rate	Fast Charge	Fast Charge	No Charge
Low Charge Rate	Slow Charge	Slow Charge	No Charge
Battery Charge Off	No Charge	No Charge	No Charge

Using a slow charge rate draws less current (power) from the input power source when the battery is mostly discharged.

Scan the appropriate barcode for your application. *Default = Automatic.*



\* Automatic



Full Charge Rate



Low Charge Rate



Battery Charge Off

---

## Linking Image Scanner to Base

When newly shipped or defaulted to factory settings, the base and image scanner are not linked. Once the image scanner is placed into the base, the software automatically links the image scanner and the base. If the image scanner and base have previously been linked, you do not receive any feedback. If this is the first time that the image scanner and base are linked, both devices emit a short chirp when their radios link. At this point, you are set to one image scanner to one base.



\*3820 shown

1. Provide power to the base.
2. Place the 3820/3820i into the base. The image scanner and base link.
3. To determine if your cordless system is set up correctly, scan one of the sample barcodes in the back of this manual. If the image scanner provides a single good read beep and the green LED lights, the image scanner has successfully linked to the base. If you receive a triple error beep and the red LED lights, the image scanner has not linked to the base.

## Image Scanner Modes

The 3820/3820i is capable of working in single image scanner mode, multiple image scanner mode, or with Bluetooth devices, other than the 2020 base.

### Unlinking the Image Scanner

If the base has an image scanner linked to it, that image scanner must be unlinked before a new image scanner can be linked. Once the previous image scanner is unlinked, it will no longer communicate with the base. To unlink an image scanner from the base, scan the Unlink Image Scanner barcode below.



Unlink Image Scanner

---

## **Single Image Scanner Operation**

There are two link modes to accommodate different applications: Locked Link Mode and Open Link Mode. Scan the appropriate barcodes included in the Open Link and Locked Link Mode explanations that follow to switch from one mode to another. *Default = Locked Link Mode.*

### **Locked Link Mode - Single Image Scanner**

If you link an image scanner to a base using the Locked Link Mode, other image scanners are blocked from being linked if they are inadvertently placed into the base. If you do place a different image scanner into the base, it will charge the image scanner, but the image scanner will not be linked.



\* Locked Link Mode  
(Single Image Scanner)

To use a different image scanner, you need to unlink the original image scanner by scanning the Unlink Image Scanner barcode. (See "[Image Scanner Modes](#)" on page 1-5.)

### **Open Link Mode - Single Image Scanner**

When newly shipped or defaulted to factory settings, the base and image scanner are not linked. By placing an image scanner into the base, they establish a link. Placing a different image scanner into the base establishes a new link and the old image scanner is unlinked. Each time an image scanner is placed into the base, it becomes the linked image scanner; the old image scanner is unlinked.



Open Link Mode  
(Single Image Scanner)

### **Override Locked Image Scanner**

If you need to replace a broken or lost image scanner that is linked to a base, scan the Override Locked Image Scanner barcode below with a new image scanner and place that image scanner in the base. The locked link will be overridden; the broken or lost image scanner's link with the base will be removed, and the new image scanner will be linked.



Override Locked Image Scanner  
(Single Image Scanner)



---

## ***Multiple Image Scanner Operation***

To put the image scanner in multiple image scanner mode, scan the barcode below. Once you scan this barcode, the image scanner is unlinked from the base and must be placed into the base to re-link.



Multiple Image Scanner Operation

*Note: Multiple Image Scanner Operation Mode allows you to link up to 7 image scanners to one base. You cannot join an eighth image scanner until you unlink one of the 7 image scanners or take an image scanner out of range.*

## ***Image Scanner Name***

You are able to assign a name to each image scanner you are using. It will be helpful to name the image scanners if you have multiple image scanners linked to one base so that you will be able to control the image scanner receiving imaging commands sent from the base. The default name for a 3820, for example, is "3820". If you have more than one 3820s linked to a base, the first image scanner that is linked to the base receives commands addressed using this name.

### ***Changing Image Scanner Name - Serially***

If you wish to change the name, you may change it via a serial command (refer to "[Menu Command Syntax](#)" on page 10-1) or via a barcode command. To change the name serially, unlink all except one of the 3820/3820i devices from the base. Send `":3820:BT_NAMname"`, where *name* is the new image scanner name. If you wish to change the name of additional 3820/3820i devices, re-link them one at a time and repeat the `":3820:BT_NAMname"` command for each image scanner.

---

## Changing Image Scanner Name - via Barcodes

If you wanted to set up your image scanners with names 0001-0007, you may scan the barcodes below. Scan the Reset barcode after each name change and wait for the image scanner to re-link to the base before scanning the next barcode to name the next image scanner.



0001



0002



0003



0004



0005



0006



0007



Reset

Alternatively, you may change the name with a barcode command if you cannot send serial commands to the base. One way to do this is to scan the barcode below and scan a number for the image scanner name. For example, if you had 7 image scanners to one base, scan the barcode below with the first image scanner, scan the **1** barcode on the [Programming Chart](#) inside the back cover of this manual and scan **Save**. Then scan the **Reset** barcode and wait for the image scanner to re-link to the base before scanning the next barcode. Repeat that process for image scanner number 2, 3, 4 etc.



Image Scanner Name

If you want to assign an alphabetic name to the image scanner, create a Code 128 barcode containing “~BT\_NAMname.” followed by a FNC3 character (hexadecimal 83), where *name* is the new image scanner name. Scan the Reset barcode (page 1-8 or on the [Programming Chart](#) inside the back cover of this manual). You may use Barcode Builder, which is included with Quick\*View. You may download Quick\*View from the Honeywell International Inc. website: [www.honeywell.com/aidc](http://www.honeywell.com/aidc).

---

## ***Image Scanner Report***

Scan the barcode below to generate a report for the connected image scanners. The report indicates the port, work group, image scanner name, and address.



Image Scanner Report

## ***Application Work Groups***

Your cordless system can have up to seven image scanners linked to one base. You can also have up to seven work groups. If you want to have all of the image scanners' settings programmed alike, you don't need to use more than one work group. If you want each image scanner to have unique settings (e.g., beeper volume, prefix/suffix, data formatter), then you may program each image scanner to its own unique work group and may program each image scanner independently. Visual XPress ([page 9-1](#)) makes it easy for you to program your system for use with multiple image scanners and multiple work groups.

The image scanner keeps a copy of the menu settings it is using. Whenever the image scanner is connected or reconnected to a base, the image scanner is updated with the latest settings from the base for its work group. The image scanner also receives menu setting changes processed by the base. If an image scanner is removed from one base and placed into another base, it will be updated with the new base settings for whatever work group that the image scanner was previously assigned. For example, if the image scanner was in work group 1 linked to the first base, it will be placed in work group 1 in the second base with the associated settings.

---

## ***Application Work Group Selection***

This programming selection allows you to assign an image scanner to a work group by scanning the barcode below. You may then program the settings (e.g., beeper volume, prefix/suffix, data formatter) that your application requires.



\* Group 0



Group 1



Group 2



Group 3



Group 4



Group 5



Group 6

---

## **Resetting the Standard Product Default Settings: Current Application Work Group**

If you aren't sure what programming options are in your image scanner, or you've changed some options and want the standard product default settings restored, scan the **Standard Product Default Settings: Current Application Group** barcode below.

The [Menu Commands](#) starting on [page 10-6](#) list the factory default settings for each of the commands (indicated by an asterisk (\*) on the programming pages).

*Note: Scanning this barcode also causes both the image scanner and the base to perform a reset and become unlinked. Refer to "Linking Image Scanner to Base" on page 1-5 for additional information.*



Standard Product Default Settings:  
Current Application Group

*Note: If your image scanner is in multiple image scanner mode and you scan either the current or all application group default barcode, you will hear up to 30 seconds of beeping while all image scanners are re-linked from the base and the settings are defaulted to \* settings. The default interface is keyboard wedge and the default image scanner mode is single image scanner locked link mode.*

## **Resetting the Standard Product Default Settings: All Application Work Groups**

The following barcode defaults all of the work groups to the factory settings.



Standard Product Default Settings:  
All Application Groups

The [Menu Commands](#) starting on [page 10-6](#) list the standard product default settings for each of the commands (indicated by an asterisk (\*) on the programming pages).

---

## Using the Image Scanner with Bluetooth Devices

The 3820/3820i image scanner may be used either with the 2020 base or with other Bluetooth devices. Scanning the Non-Base Bluetooth Connection barcode below allows the image scanner to be used with other Bluetooth devices (e.g., PDA, PC - Bluetooth USB Adapter). After you scan the barcode below, follow the instructions supplied with your Bluetooth device to locate the image scanner and connect to it. If you go out of range with your image scanner, the image scanner automatically reconnects to the Bluetooth device. If you want to relink to the 2020 base, refer to *"Override Locked Image Scanner"* on page 1-6 or *"Resetting the Standard Product Default Settings: All Application Work Groups"* on page 1-11.

*Note: The multiple work groups option is not available when you are using the imager with Bluetooth devices other than the 2020 base.*



Non-Base BT Connection

### Changing Bluetooth PIN Code

Some devices require a PIN code as part of the Bluetooth security features. Your image scanner's default PIN is 1234, which you may need to enter the first time you connect to your PDA or PC. The PIN code must be between 1 and 16 characters. To change the PIN, scan the barcode below and then scan the appropriate numeric barcodes from the [Programming Chart](#) inside the back cover of this manual. Scan **Save** to save your selection.



Bluetooth PIN

*Note: Refer to [Minimizing Bluetooth/ISM Band Network Activity](#) beginning on page B-1 for additional Bluetooth/ISM information.*

## Out-of-Range Alarm

### Duration

If your image scanner is out range of the base, an alarm sounds from both your base and image scanner. To activate the alarm options for the image scanner or the base and to set the alarm duration, scan the appropriate barcode below

---

and then set the time-out duration (from 0-3000 seconds) by scanning digits on the [Programming Chart](#) inside the back cover, then scanning **Save**. *Default = 0 sec (no alarm).*



Base Alarm Duration



Image Scanner Alarm

*Note: If you are out of range when you scan a barcode, you will receive an error beep even if you do not have the alarm set. You receive the error beep since the data could not be communicated to the base or the host.*

### **Alarm Sound Type**

If you have set the out-of-range alarm enabled, you may change the alarm type for the image scanner or base by scanning the appropriate barcode below and then scanning a digit (0-7) barcode and the **Save** barcode on the [Programming Chart](#) inside the back cover of this manual. *Default = 0.* Set the sound type to fit your application.



Base Alarm Type



Image Scanner Alarm Type

### **Data Accumulation Mode**

Scan the barcodes below to turn data accumulation (batch) mode on and off. If data accumulation mode is on, barcode data is stored when the image scanner is out of range of the base and transmitted once the image scanner is back in range.



Data Accumulation Mode On



\* Data Accumulation Mode Off

---

## **Batch Mode Transmit Delay**

Sometimes when accumulated scans are sent to the host system, the transmission of those scans is too fast for the application to process. To program a transmit delay between accumulated scans, scan one of the following delays.

*Note: In most cases, a short (250 ms (milliseconds) delay is ideal; however, longer delays may be programmed. Contact Technical Support ([page 15-1](#)) for additional information.*



\* Batch Mode Transmit Delay Off  
(No Delay)



Batch Mode Transmit Delay Short  
(250 ms)



Batch Mode Transmit Delay Medium  
(500 ms)



Batch Mode Transmit Delay Long  
(1000 ms)

## **Beeper and LED Sequences and Their Meaning**

The 3820/3820i contains LEDs on the top of the unit to indicate its power up, communication, and battery status. Simply stated, red LED = error; green LED = success of any type. The unit's audible indicators have meaning as well: 3 beeps = error; 2 beeps = menu change; 1 beep = all other successes.

The table below lists the indication and cause of the LED illumination and beeps for the 3820/3820i.



---

### ***3820/3820i LED Sequences and Their Meaning***

<b>LED Indication</b>	<b>Beeper Indication</b>	<b>Cause</b>
Normal Operation		
Red Flash	None	Battery low
Green Flash	1 beep	Successful communication or linking
Red, blinking	3 beeps	Failed communication
Menu Operation		
Green Flash	2 beeps	Successful menu change
Red, blinking	3 beeps	Unsuccessful menu change

### ***2020 LED Sequences and Their Meaning***

The base contains a red LED that indicates the status of the unit and verifies its communication with the host system and a green LED that indicates image scanner battery charge condition.

The tables below list the indication and cause of the LED illumination and beeps for the 2020.

<b>System Condition</b>	<b>System Status Indicator (Red LED)</b>
Power On/System Idle	LED is on
Power On/Diagnostic Error	Blink LED for long duration, pulsing indefinitely
Receiving Data (2020 only)	Blink LED for short duration in multiple pulses. Occurs while transferring data to/from the RF module or the Host port.
Base requests status from its own Bluetooth radio	Blink LED once (occurs approx. every 30 seconds)

*Note: Charging only occurs with external power applied to the 2020 or 12 volt Host power.*

<b>Charge Condition</b>	<b>Charge Status Indicator (Green LED)</b>
Image Scanner inserted into base	Three flashes
>80% charged	On continuously
30% to 80% charged	Slow flash, 1 second on, 1 second off
<30% charged	Fast flash, 300 mSec on, 300 mSec off

## **Basic Operation of the Cordless System**

### **Cordless Base**

The cordless base provides the link between the cordless image scanner and the host system. The base contains an interface assembly and an RF communication module. The RF communication module performs the data exchange between the cordless image scanner and the interface assembly. The control assembly coordinates the central interface activities including: transmitting/receiving commands and data to/from the host system, performing software activities (parameter menuing, visual indicator support, power-on diagnostics), and data translation required for the host system.

The base also is the image scanner battery charger with the external 9VDC power source applied. Once you place the image scanner into base, the base green LED responds according to the Charge Status Indicator table above.

The base can be powered by the Host (parasitic power mode). If the base is in parasitic power mode without the 9VDC power source, the base will still function, but will not charge the battery.

---

## ***RF (Radio Frequency) Module Operation***

The cordless system uses a state-of-the-art two-way Bluetooth radio to transmit and receive data between the image scanner and the base. Designed for point-to-point and multipoint-to-single point applications, the radio operates using a license free ISM band, which sends relatively small data packets at a fast data rate over a radio signal with randomly changing frequencies, makes the cordless system highly responsive to a wide variety of data collection applications and resistant to noisy RF environments. Bluetooth Class 2 power level provides range of 33 feet (10m) depending on the environment.

### ***Cordless Image Scanner***

The cordless image scanner enables fast and accurate barcode scanning using a non-contact linear image scanner.

The image scanner is comprised of a linear image scanner, a decode/control assembly, and an RF communication module. The scan engine performs the barcode image illumination and sensing. The decode/control assembly coordinates the central communication activities including: capturing and decoding the barcode image data, performing software activities (parameter menuing, visual indicator support, low battery indication), and data translation required for the host system. The RF communication module performs the data exchange between the image scanner and the base.

### ***System Conditions***

The components of the cordless system interact in specific ways as you associate an image scanner to a base, as you move an image scanner out of range, bring an image scanner back in range, or swap image scanners between two cordless systems. The following information explains the cordless system operating conditions.

#### ***Linking Process***

Once an image scanner is placed into the base, the image scanner's battery charge status is checked, and software automatically detects the image scanner and links it to the base depending on the selected link mode.

#### ***Image Scanner Is Out of Range***

The cordless image scanner is in communication with its base, even when it is not transmitting barcode data. Whenever the image scanner can't communicate with the base for a few seconds, it is out of range. If the image scanner is out of range and you scan a barcode, the image scanner issues a triple beep indicating no communication with the base. In addition, your image scanner and base can sound an alarm if programmed to emit an alarm. See [Out-of-Range Alarm on page 1-12](#).

#### ***Image Scanner Is Moved Back Into Range***

The image scanner re-links if the image scanner or the base have been reset or out of range. If the image scanner re-links, you will hear a single chirp when the re-linking process (uploading of the parameter table) is complete.

---

## ***Out of Range and Back into Range with Data Accumulation Mode On***

The image scanner may store a number of symbols (approximately 500 UPC symbols, others may vary) when out of range and then send them to the base when back in range. You will not hear a communication error beep in this mode, but you will hear a short buzz when you pull the trigger if the radio communication is not working. Once the radio connection is made, the image scanner produces a series of beeps while the data is being transferred to the base.

## ***Communication Between the Cordless System and the Host***

The cordless image scanner provides immediate feedback in the form of a “good read” indication (a green LED on the image scanner and an audible beep) after a barcode is scanned correctly and the base has acknowledged receiving the data. This is possible since the cordless system provides two-way communication between the image scanner and the base.

When data is scanned, the data is sent to the host system via the base unit. Confirmation from the host system or the base indicates that the data sent was received by the host. The cordless image scanner recognizes data acknowledgement (ACK) from the base unit. If it cannot be determined that the data has been properly sent to the base, the image scanner issues an error indication. You must then check to see if the scanned data was received by the host system.

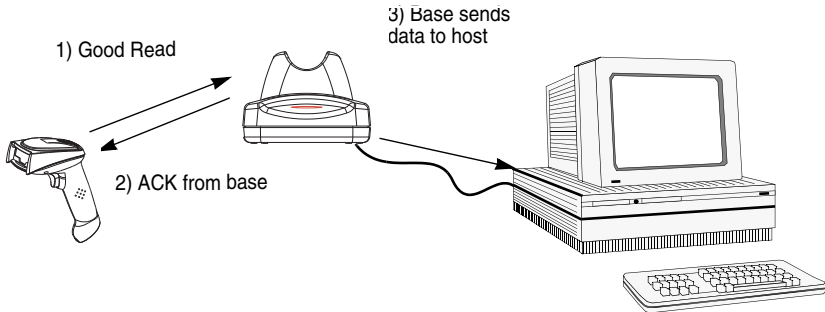

## ***Connecting the Base When Powered by Host (Keyboard Wedge)***

A base can be connected between the keyboard and PC as a “keyboard wedge,” plugged into the serial port, or connected to a portable data terminal in wand emulation or non decoded output mode. The following is an example of a keyboard wedge connection:

1. Turn off power to the terminal/computer.

---

2. Disconnect the keyboard cable from the back of the terminal/computer.

3. Connect the appropriate interface cable to the base and to the terminal/computer and keyboard. Make sure the cables are secured in the wireways in the bottom of the base and that the base sits flat on a horizontal surface.

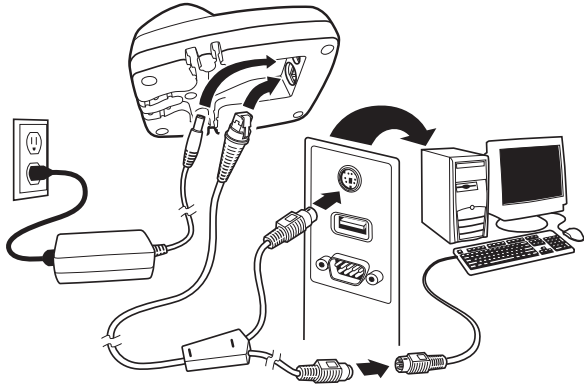

4. Turn the terminal/computer power back on.

5. Program the base for the keyboard wedge interface. See "[Keyboard Wedge Connection](#)" on page 1-21.)

6. Verify the base operation by scanning a barcode from the [Sample Symbols](#) in the back of this manual.

*Note: Without using the 9-volt external, power supply, the base only uses enough power from the host to operate the interface. The image scanner's battery is not charged when in this mode. Using the 9-volt, external power supply allows the image scanner's battery to be charged, and no power is drawn from the host.*

---

## Reading Techniques

The image scanner has a view finder that projects a bright red aiming beam that corresponds to its horizontal field of view. The aiming line should be centered horizontally over the barcode; it will not read if the aiming line is in any other direction.

**Good Read**



**Bad Read**

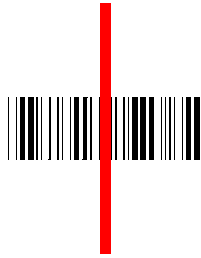

**Bad Read**



The best focus point for reading most code densities is about 5 inches (12.7 cm) from the unit. To read single or multiple symbols (on a page or on an object), hold the image scanner at an appropriate distance from the target, pull the trigger, and center the aiming line on the symbol.

## Resetting the Standard Product Defaults

If you aren't sure what programming options are in your image scanner, or you've changed some options and want the factory settings restored, scan the **Standard Product Default Settings** barcode below.

The [Menu Commands](#) starting on [page 10-6](#) lists the factory default settings for each of the commands (indicated by an asterisk (\*) on the programming pages).

*Note: Scanning this barcode also causes both the image scanner and the base to perform a reset and become unlinked. Refer to "Linking Image Scanner to Base" on page 1-5 for additional information.*



Standard Product Default Settings

---

## Plug and Play

Plug and Play barcodes provide instant image scanner set up for commonly used interfaces.

*Note: After you scan one of the codes, power cycle the host terminal to have the interface in effect.*

## Keyboard Wedge Connection

If you want your system programmed for an IBM PC AT and compatibles keyboard wedge interface with a USA keyboard, scan the barcode below. Keyboard wedge is the default interface.

*Note: The following barcode also programs a carriage return (CR) suffix.*



## Laptop Direct Connect

For most laptops, scanning the **Laptop Direct Connect** barcode allows operation of the image scanner in parallel with the integral keyboard. The following Laptop Direct Connect barcode selects terminal ID 03, programs a carriage return (CR) suffix and turns on Emulate External Keyboard ([page 2-6](#)).



## RS-232

The **RS-232** Interface barcode is used when connecting to the serial port of a PC or terminal. The following RS-232 Interface barcode also programs a carriage return (CR) and a line feed (LF) suffix, baud rate, and data format as indicated below. It also changes the trigger mode to manual.

<u>Option</u>	<u>Setting</u>
Baud Rate	115,200 bps
Data Format	8 data bits, no parity bit, 1 stop bit



---

## **Wand Emulation Plug & Play**

In Wand Emulation mode, the image scanner decodes the barcode then sends data in the same format as a wand scanner. The Code 39 Format converts all symbologies to Code 39.

The Same Code Format transmits UPC, EAN, Code 128 and Interleaved 2 of 5 without any changes, but converts all other symbologies to Code 39.

The **Wand Emulation Plug & Play Code 39 Format** barcode below sets the terminal ID to 61. The **Wand Emulation Plug & Play Same Code Format** barcode sets the terminal ID to 64. These Plug & Play barcodes also set the Transmission Rate to 25 inches per second, Output Polarity to black high, and Idle State to high. (If you want to change the terminal ID *only*, without changing any other image scanner settings, please refer to [Terminal ID](#) on page 2-1.)



Wand Emulation (Code 39 Format)



Wand Emulation Same Code

## **IBM 4683 Ports 5B, 9B, and 17 Interface**

Scan one of the following “Plug and Play” codes to program the 3820/3820i for IBM 4683 Port 5B, 9B, or 17.

*Note: After scanning one of these codes, you must power cycle the cash register.*



IBM 4683 Port 5B Interface



IBM 4683 Port 9B HHBCR-1 Interface



IBM 4683 Port 9B HHBCR-2 Interface



IBM 4683 Port 17 Interface



---

Each barcode above also programs the following suffixes for each symbology:

<b><u>Symbology</u></b>	<b><u>Suffix</u></b>
EAN 8	0C
EAN 13	16
UPC A	0D
UPC E	0A
Code 39	00 0A 0B
Interleaved 2 of 5	00 0D 0B
Code 128 *	00 0A 0B
Code 128 **	00 18 0B

\* Suffixes programmed for Code 128 with IBM 4683 Port 5B, IBM 4683 Port 9B HHBCR-1, and IBM 4683 Port 17 Interfaces

\*\*Suffixes programmed for Code 128 with IBM 4683 Port 9 HHBCR-2 Interface

## ***Connecting the Base with USB***

A base can be connected to the USB port of a computer.

1. Connect the appropriate interface cable to the base and to the computer. Make sure the cables are secured in the wireways in the bottom of the base and that the base sits flat on a horizontal surface.

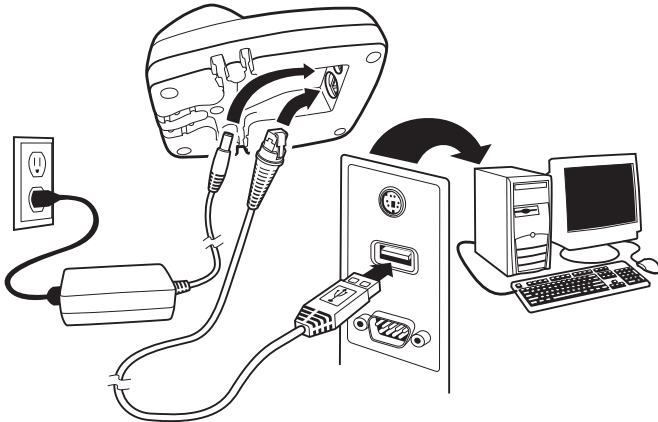

2. Program the base for the USB interface by scanning the appropriate programming barcode.
3. Verify the base operation by scanning a barcode from the [Sample Symbols](#) in the back of this manual.

---

For additional USB programming and technical information, refer to Honeywell "USB Application Note," available at [www.honeywell.com/aidc](http://www.honeywell.com/aidc).

*Note: Without using the 9-volt external, power supply, the base only uses enough power from the host to operate the interface. The image scanner's battery is not charged when in this mode. Using the 9-volt, external power supply allows the image scanner's battery to be charged, and no power is drawn from the host.*

### **IBM SurePos**

Scan one of the following "Plug and Play" codes to program the 3820/3820i for IBM SurePos (USB Hand Held image scanner) or IBM SurePos (USB Tabletop scanner).

*Note: After scanning one of these codes, you must power cycle the cash register.*



IBM SurePos (USB Hand  
Held Image Scanner)  
Interface



IBM SurePos (USB Tabletop  
Scanner) Interface

Each barcode above also programs the following suffixes for each symbology:

<b><u>Symbology</u></b>	<b><u>Suffix</u></b>
EAN 8	0C
EAN 13	16
UPC A	0D
UPC E	0A
Code 39	00 0A 0B
Interleaved 2 of 5	00 0D 0B
Code 128	00 18 0B

### **USB PC or Macintosh Keyboard**

Scan one of the following codes to program the 3820/3820i for USB PC Keyboard or USB Macintosh Keyboard. Scanning these codes adds a CR and LF, along with selecting the terminal ID (USB PC Keyboard - 124, USB Macintosh Keyboard - 125, USB Japanese Keyboard (PC) - 134).



USB Keyboard (PC)



USB Keyboard (Mac)



USB Japanese Keyboard (PC)

### **USB HID**

Scan the following code to program the 3820/3820i for USB HID barcode scanners. Scanning this code changes the terminal ID to 131.



USB HID barcode Image  
Scanner

### **USB Com Port Emulation**

Scan the following code to program the 3820/3820i to emulate a regular RS-232-based Com Port. If you are using a Microsoft® Windows® PC, you will need to download a driver from the Honeywell website ([www.honeywell.com/aidc](http://www.honeywell.com/aidc)). The driver will use the next available Com Port number. Apple® Macintosh computers recognize the image scanner as a USB CDC class device and automatically uses a class driver. Scanning the code below changes the terminal ID to 130.



USB Com Port Emulation

*Note: No extra configuration (e.g., baud rate) is necessary.*

### **CTS/RTS Emulation**



USB CTS/RTS Emulation On



\* USB CTS/RTS Emulation Off

---

## ACK/NAK Mode



ACK/NAK On



\* ACK/NAK Off

## Connecting the Base with Serial Wedge

The 2020 uses TTL signal levels to wedge into an RS-232 serial network. Use only 2020 serial wedge cables to prevent damage to the base. Refer to [Connecting the Base with RS-232 Serial Port](#) on page 2-8 to set the baud rate and communications protocol.

1. Turn off power to the computer.
2. Disconnect the existing serial cable from the computer.
3. Connect the appropriate interface cable to the base. Make sure the cables are secured in the wireways in the bottom of the base and that the base sits flat on a horizontal surface.

*Note: For the base to work properly, you must have the correct cable for your type of computer.*

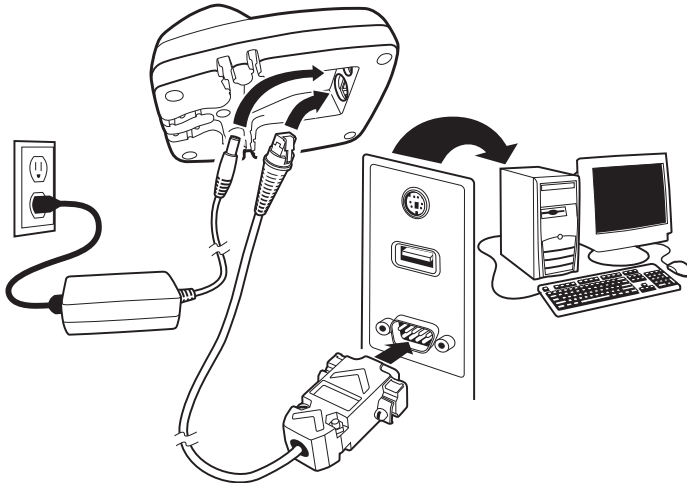

4. Plug the serial connector into the serial port on your computer. Tighten the two screws to secure the connector to the port.

- 
5. Plug the other serial connector into the other device connection and tighten the two screws.
  6. Plug the power supply barrel connector to the base, and plug the power supply into the AC source.
  7. Once the base has been fully connected, power up the computer.

To set up the serial wedge terminal ID, use the serial terminal ID 050 and follow the instructions on [page 2-1](#). Make sure that all of the communication parameters match on all of the connected devices. Choosing Both sends scanned data to P1 and P2. Default = P1.



\* P1



P2



Both P1 and P2



## Terminal ID

If your interface is not a standard PC AT, refer to "Supported Terminals" on page 2-2 through page 2-3, and locate the Terminal ID number for your PC. Scan the **Terminal ID** barcode below, then scan the numeric barcode(s) from the **Programming Chart** inside the back cover of this manual to program the image scanner for your terminal ID. Scan **Save** to save your selection.

For example, an IBM AT terminal has a Terminal ID of 003. You would scan the **Terminal ID** barcode, then **0, 0, 3** from the **Programming Chart** inside the back cover of this manual, then **Save**. If you make an error while scanning the digits (before scanning Save), scan the **Discard** code on the **Programming Chart**, scan the **Terminal ID** barcode, scan the digits, and the **Save** code again.

*Note: The default interface for the 2020-5BE is Keyboard Wedge (Term ID = 003).*



Terminal ID



Save

*Note: After scanning one of these codes, you must power cycle your computer.*

## Supported Terminals

<u>Terminal</u>	<u>Model(s)</u>	<u>Terminal ID</u>
DEC	VT510, 520, 525 (PC style)	005
DEC	VT510, 520, 525 (DEC style LK411)	104
Esprit	200, 400	005
Heath Zenith	PC, AT	003*
HP	Vectra	003*
IBM	XT	001
IBM	PS/2 25, 30, 77DX2	002
IBM	AT, PS/2 30–286, 50, 55SX, 60, 70, 70–061, 70–121, 80	003*
IBM 102 key	3151, 3161, 3162, 3163, 3191, 3192, 3194, 3196, 3197, 3471, 3472, 3476, 3477	006
IBM 122 key	3191, 3192, 3471, 3472	007
IBM 122 key	3196, 3197, 3476, 3477, 3486, 3482, 3488	008
IBM 122 key	3180	024
IBM 122 key	3180 data entry keyboard	114
IBM DOS/V 106 key	PC & Workstation	102
IBM SurePOS	USB Hand Held Scanner	128**
IBM SurePOS	USB Tabletop Scanner	129**
IBM Thinkpad	360 CSE, 340, 750	097
IBM Thinkpad		106
IBM Thinkpad	365, 755CV	003*
I/O 122 key	2676D, 2677C, 2677D	008
ITT	9271	007
Lee Data	IIS	007
NEC	98XX Series	103
Olivetti	M19, M200	001
Olivetti	M240, M250, M290, M380, P500	003*
RS-232 TTL		000
Serial Wedge		050
Silicon Graphics	Indy, Indigoll	005
Telex 88 key	078, 078A, 79, 80, 191, 196, 1191, 1192, 1471, 1472, 1476, 1477, 1483	025
Telex 88 key	Data Entry Keyboard	112
Telex 102 key	078, 078A, 79, 80, 191, 196, 1191, 1192, 1471, 1472, 1476, 1477, 1483	045



---

## **Supported Terminals**

<b><u>Terminal</u></b>	<b><u>Model(s)</u></b>	<b><u>Terminal ID</u></b>
Telex 122 key	078, 078A, 79, 80, 191, 196, 1191,1192, 1471, 1472, 1476, 1477, 1482, 1483	046
USB PC Keyboard		124**
USB Mac Keyboard		125**
USB Com Port		130
USB HIDPOS		131**
Wand Emulation (Code 39 Format)		061
Wand Emulation (Same Code Format)		064

\* Default for 2020-5BE.

\*\*It is best to use the Plug and Play barcodes, beginning on [page 1-24](#) to program these interfaces, rather than scanning the terminal ID listed in this table.

---

## Keyboard Country

Scan the appropriate country code below to program the keyboard for your country. As a general rule, the following characters are supported, but need special care for countries other than the United States:

@ | \$ # { } [ ] = / ' \ < > ~



\* United States



Belgium



Brazil



Canada (French)



Czech Republic



Denmark



Finland (Sweden)



France



Germany/Austria



Greece



Hungary



Israel (Hebrew)

---

***Keyboard Country (continued)***



Italy



Netherlands (Dutch)



Poland



Romania



SCS



Spain



Switzerland (German)



Turkey Q



Latin America



Norway



Portugal



Russia



Slovakia



Sweden



Turkey F



U.K.

---

Please refer to the Honeywell website ([www.honeywell.com/aidc](http://www.honeywell.com/aidc)) for complete keyboard country support information and applicable interfaces. If you need to program a keyboard for a country other than one listed above, scan the **Program Keyboard Country** barcode below, then scan the numeric barcode(s) for the appropriate country from the inside back cover, then the **Save** barcode.



## Keyboard Style

This programs keyboard styles, such as Caps Lock and Shift Lock. *Default = Regular.*

**Regular** is used when you normally have the Caps Lock key off.



**Caps Lock** is used when you normally have the Caps Lock key on.



**Shift Lock** is used when you normally have the Shift Lock key on (not common to U.S. keyboards).



**Automatic Caps Lock** is used if you change the Caps Lock key on and off. The software tracks and reflects if you have Caps Lock on or off (AT and PS/2 only). This selection can only be used with systems that have an LED which notes the Caps Lock status.



**Autocaps via NumLock** barcode should be scanned in countries (e.g., Germany, France) where the Caps Lock key cannot be used to toggle Caps Lock. The NumLock option works similarly to the regular Autocaps, but uses the NumLock key to retrieve the current state of the Caps Lock.



---

**Emulate External Keyboard** should be scanned if you do not have an external keyboard (IBM AT or equivalent).



Emulate External Keyboard

*Note: After scanning the Emulate External Keyboard barcode, you must power cycle your computer.*

## Keyboard Modifiers

This modifies special keyboard features, such as CTRL+ ASCII codes and Turbo Mode.

**Control + ASCII Mode On:** The image scanner sends key combinations for ASCII control characters for values 00-1F. Refer to [Keyboard Function Relationships](#), page 7-1 for CTRL+ ASCII Values. *Default = Off*



Control + ASCII Mode On



\* Control + ASCII Mode Off

**Turbo Mode:** The image scanner sends characters to a terminal faster. If the terminal drops characters, do not use Turbo Mode. *Default = Off*



Turbo Mode On



\* Turbo Mode Off

**Numeric Keypad Mode:** Sends numeric characters as if entered from a numeric keypad. *Default = Off*



Numeric Keypad Mode On



\* Numeric Keypad Mode Off

---

**Automatic Direct Connect Mode:** This selection can be used if you have an IBM AT style terminal and the system is dropping characters. *Default = Off*



Automatic Direct  
Connect Mode On



\* Automatic Direct Connect  
Mode Off

## Connecting the Base with RS-232 Serial Port

1. Turn off power to the terminal/computer.
2. Connect the appropriate interface cable to the base.

*Note: For the base to work properly, you must have the correct cable for your type of terminal/computer.*

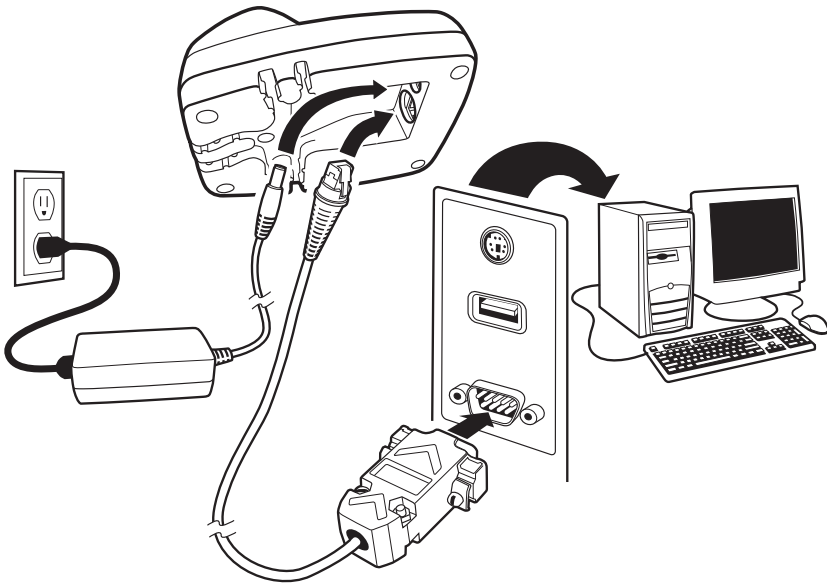

3. Plug the serial connector into the serial port on your computer. Tighten the two screws to secure the connector to the port.
4. Plug the power supply barrel connector to the base, and plug the power supply into the AC source.

---

5. Once the base has been fully connected, power up the computer.

All communication parameters between the image scanner and terminal must match for correct data transfer through the serial port using RS-232 protocol. Scanning the RS-232 interface barcode, programs the image scanner for an RS-232 interface at 115,200 baud, parity–none, 8 data bits, 1 stop bit, and adds a suffix of a CR LF.



RS-232 Interface

### ***RS-232 Baud Rate***

Baud Rate sends the data from the image scanner to the terminal at the specified rate. The host terminal must be set for the same baud rate as the image scanner.

*Default = 115,200.*



300



1200



4800



19200



57,600



600



2400



9600



38400



\* 115,200

---

## **RS-232 Word Length: Data Bits, Stop Bits, and Parity**

**Data Bits** sets the word length at 7 or 8 bits of data per character. If an application requires only ASCII Hex characters 0 through 7F decimal (text, digits, and punctuation), select 7 data bits. For applications which require use of the full ASCII set, select 8 data bits per character. *Default = 8.*

**Stop Bits** sets the stop bits at 1 or 2. *Default = 1.*

**Parity** provides a means of checking character bit patterns for validity. *Default = None.*



7 Data, 1 Stop, Parity Even



7 Data, 1 Stop, Parity Odd



7 Data, 2 Stop, Parity None



8 Data, 1 Stop, Parity Even



8 Data, 1 Stop, Parity Odd



7 Data, 1 Stop, Parity None



7 Data, 2 Stop, Parity Even



7 Data, 2 Stop, Parity Odd



\* 8 Data, 1 Stop, Parity None

## **RS-232 Handshaking**

RS-232 Handshaking allows control of data transmission from the image scanner using software commands from the host device. CTS/RTS operates in mode 2. When this feature is turned **Off**, no data flow control is used. When Data Flow Control is turned **On**, the host device suspends transmission by sending the XOFF character (DC3, hex 13) to the image scanner. To resume



---

transmission, the host sends the XON character (DC1, hex 11). Data transmission continues where it left off when XOFF was sent. *Default = RTS/CTS, XON/XOFF and ACK/NAK Off.*



RTS/CTS On



\* RTS/CTS Off



XON/XOFF On



\* XON/OFF Off



ACK/NAK On



\* ACK/NAK Off

### **Host ACK Selection**

Some applications require that the host terminal (or server) approve or reject incoming barcode data and notify the operator of these actions. These applications require that the host maintain control over the response indicators emitted from the source image scanner. Turning the Host ACK selection on, configures the cordless system image scanners to respond to commands from the host system.

The following criteria must be met for the Host ACK to work correctly:

- The cordless system must be configured for Host Port RS-232 (terminal ID = 000) or USB COM Emulation (terminal ID = 130).
- RTS/CTS is defaulted off. You must enable it if the host system requires it.
- Host ACK must be enabled ([page 2-12](#)).
- System performance degrades when using Host ACK at rates lower than 9600.
- The host terminal software must be capable of interpreting the barcode data, make decisions based on the data content, and send out appropriate escape commands to the source image scanner.

Escape commands are addressed to the source image scanner via “Application Work Groups.” Once a command is sent, all image scanners in a group respond to that command. Because of this situation, **it is recommended that each image scanner is assigned to its own group in host ACK mode.**

The commands to which the image scanner responds are listed on page 2-13. The **<ESC>** is a **1B** in hex. A typical command string is **y <ESC> x**, where “y” is the application work group number, “<ESC> x” is the escape command, and the comma is the terminator, which is required.

---

Commands may be strung together to create custom response sequences. An example of a command string is listed below.

0<ESC>4<ESC>5<ESC>6,

The above example will make an image scanner in application work group zero beep low, medium, high.

Once Host ACK is enabled, the system works as follows:

- The image scanner reads a code and sends data to the base/host system. No audible or visual indication is emitted until you receive an escape command. The image scanner read illumination goes out upon a successful read.
- Image Scanner is suspended until 1) a valid escape string is received from the host system (via the base) or 2) the image scanner “times out.”
- Once condition 1 or 2 above has been met, the image scanner is ready to scan again, and the process repeats.

Time out is indicated by three rapid beeps at the same pitch. A time out occurs if the source image scanner does not receive a valid escape command in 10 seconds. If a time out occurs, the operator should check the host system to understand why a response to the image scanner was not received.

### ***Host ACK Enable***



Host ACK On



\* Host ACK Off

## 2020 Host Escape Commands

Command	Action
<ESC> a	Indicate as if successful menu change made
<ESC> b	Indicate as if unsuccessful menu change made
<ESC> 1	Illuminate green LED for 135 milliseconds (followed by at least 70 mSecs. dark time when multiple blinks)
<ESC> 2	Illuminate green LED for two seconds (followed by at least 500 mSecs. dark time when multiple blinks)
<ESC> 3	Illuminate green LED for five seconds (followed by at least 500 mSecs. dark time when multiple blinks)
<ESC> 4	One beep at low pitch tone
<ESC> 5	One beep at medium pitch tone
<ESC> 6	One beep at high pitch tone
<ESC> 7	Indicate as successful decode and communication to host.
<ESC> 8	Indicate as unsuccessful decode and communication to host.

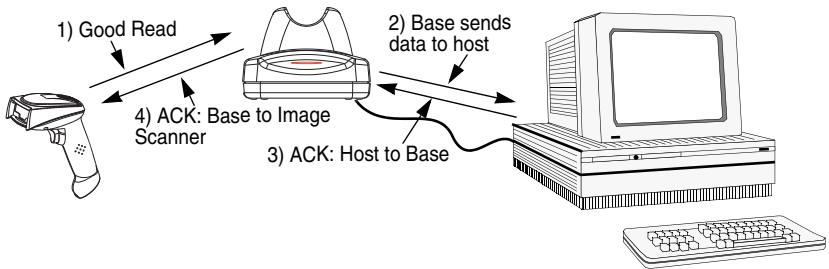

---

## Wand Emulation

### Wand Emulation Connection

The Wand Emulation Connection barcodes should be used if you want to change the terminal ID *only*, without changing any other image scanner settings. We recommend using Wand Emulation Plug & Play barcodes to program your image scanner to emulate a wand reader. The Wand Emulation Plug & Play barcodes change other parameters, in addition to changing the terminal ID. Please refer to [Wand Emulation Plug & Play](#) on page 1-22 for further information.

In Wand Emulation mode, the image scanner decodes the barcode then sends data in the same format as a wand scanner. The Code 39 Format converts all symbologies to Code 39.

The Same Code Format transmits UPC, EAN, Code 128 and Interleaved 2 of 5 without any changes, but converts all other symbologies to Code 39. 2D symbologies are converted to Code 128.

The **Code 39 Format** barcode below sets the terminal ID to 61, and the **Same Code Format** barcode sets the terminal ID to 64.



Code 39 Format



Same Code Format

---

### **Wand Emulation Transmission Rate**

The transmission rate is limited by the terminal's ability to receive data without dropping characters. *Default = 25 inches/second.*



10



40



120



200



\* 25



80



150

### **Wand Emulation Polarity**

The Polarity can be sent as standard with black bars high, or reversed with white bars high. *Default = Black High.*



\* Black High



White High

### **Wand Emulation Idle**

The idle describes the state of the image scanner when no data is being transmitted. When in Wand Emulation mode, you must set the image scanner's idle state to match the idle state for the device to which the image scanner is connected. *Default = Idle High.*



\* Idle High



Idle Low

---

### **Wand Emulation Data Block Size**

This transmits the data in smaller blocks to prevent buffer overflow. *Default = 40.*



### **Wand Emulation Delay Between Blocks**

This sets the delay time between data blocks. *Default = 50ms.*



### **Wand Emulation Overall Checksum**

When this option is turned on, a computed check character is added at the end of the entire message. The check character is the character which when Exclusive-OR'd with every preceding character of the message yields a result of 0x00 (00H). *Default = Off.*



Wand Emulation Overall  
Checksum On



\* Wand Emulation Overall  
Checksum Off

## Image Scanner Functions

### Good Read Indicators

#### Beeper – Good Read

The beeper may be programmed On or Off in response to a good read. Turning this option off, only turns off the beeper response to a good read indication. All error and menu beeps are still audible. *Default = On.*



\* Beeper - Good Read On



Beeper - Good Read Off

#### Beeper Volume – Good Read

The beeper volume codes modify the volume of the beep the image scanner emits on a good read. *Default = Medium.*



Low



\* Medium



High



Off

---

### ***Beeper Pitch – Good Read***

The beeper pitch codes modify the pitch (frequency) of the beep the image scanner emits on a good read. *Default = Medium.*



Low (1600 Hz)



\* Medium (3250 Hz)



High (4200 Hz)

### ***Beeper Duration – Good Read***

The beeper duration codes modify the length of the beep the image scanner emits on a good read. *Default = Normal.*



\* Normal Beep



Short Beep

### ***LED – Good Read***

The LED indicator can be programmed On or Off in response to a good read. *Default = On.*



\*LED - Good Read On



LED - Good Read Off

### ***Number of Beeps – Good Read***

The number of beeps of a good read can be programmed from 1 - 9. The same number of beeps will be applied to the beeper and LED in response to a good read. For example, if you program this option to have five beeps, there will be five beeps and five LED flashes in response to a good read. The beeps and LED flashes are in sync with one another. To change the number of beeps, scan the barcode below and then scan a digit (1-9) barcode and the **Save** barcode on the [Programming Chart](#) inside the back cover of this manual. *Default = One.*



Number of Beeps/LED Flashes



---

## Good Read Delay

This sets the minimum amount of time before the image scanner can read another barcode. *Default = 0 ms (No Delay).*



\* No Delay



Short Delay (500 ms)



Medium Delay (1000 ms)



Long Delay (1500 ms)

### User-Specified Good Read Delay

If you want to set your own length for the good read delay, scan the barcode below, then set the delay (from 0-30,000 milliseconds) by scanning digits from the inside back cover, then scanning **Save**.



User-Specified Good Read Delay

## Image Scanner Trigger Modes

### Manual/Serial Trigger, Low Power

You can activate the image scanner either by pressing the trigger, or using a serial trigger command (see "[Trigger Commands](#)" on page 10-4). When in manual trigger mode, the image scanner scans until a barcode is read, or until the trigger is released.

When in serial mode, the image scanner scans until a barcode has been read or until the deactivate command is sent. In serial mode, the image scanner can also be set to turn itself off after a specified time has elapsed (see [Read Time-Out \(Serial Trigger Mode\)](#), which follows).



\* Manual/Serial Trigger

---

### **Read Time-Out (Serial Trigger Mode)**

Use this selection to set a time-out (in milliseconds) of the image scanner's trigger when using serial commands to trigger the image scanner. Once the image scanner has timed out, you can activate the image scanner either by pressing the trigger or using a serial trigger command. After scanning the **Read Time-Out** barcode, set the time-out duration (from 0-300,000 milliseconds) by scanning digits on the [Programming Chart](#) inside the back cover, then scanning **Save**. *Default = 30,000 ms.*



Read Time-Out

### **Image Scanner Power Time-Out Timer**

*Note: The Image Scanner Power Time-out Timer option only applies to Manual/Serial Trigger.*

When there is no activity within a specified time period, the image scanner enters low power mode. Scan the appropriate Image Scanner Power Time-Out barcode to change the time-out duration (in seconds).

*Note: Scanning zero (0) is the equivalent of setting no time-out.*

---

If there are no trigger pulls during the “image scanner power time-out timer” interval, the image scanner goes into power down mode. Whenever the trigger is enabled, the “image scanner power time-out timer” is reset. If the image scanner is placed in the 2020 cradle and the battery is in the process of being charged, the image scanner will not go into power down mode.



0 seconds



200 seconds



400 seconds



900 seconds



\* 3600 seconds



7200 seconds

*Note: When the image scanner is in power down mode, pull the trigger to power the unit back up. There will be a set of power up beeps and a delay of up to a few seconds for the radio to join. The image scanner will then be ready to use.*

### **Automatic Trigger**

The image scanner scans continuously at full power with illumination fully on.



Automatic Trigger

### **Presentation Mode**

The LEDs are off until a barcode is presented to the image scanner. Then the LEDs turn on automatically to read the code. Presentation Mode uses ambient light to detect the barcodes. If the light level in the room is not high enough, Presentation Mode will not work properly.



Presentation Mode

---

## Hands Free Time-Out

The Automatic Trigger and Presentation Modes are referred to as “hands free” modes. If the image scanner’s trigger is pulled when using a hands free mode, the image scanner changes to manual trigger mode. You can set the time the image scanner should remain in manual trigger mode by setting the Hands Free Time-Out. Once the time-out value is reached, (if there have been no further trigger pulls) the image scanner reverts to the original hands free mode.

Scan the **Hands Free Time-Out** barcode, then scan the time-out duration (from 0-300,000 milliseconds) from the inside back cover, and **Save**. *Default = 5,000 ms.*



Hands Free Time-Out

## Reread Delay

This sets the time period before the image scanner can read the *same* barcode a second time. Setting a reread delay protects against accidental rereads of the same barcode. Longer delays are effective in minimizing accidental rereads at POS (point of sale). Use shorter delays in applications where repetitive barcode scanning is required. *Default = Medium.*

Reread Delay only works when in automatic trigger mode (see [page 3-5](#)).



Short (500 ms)



\* Medium (750 ms)



Long (1000 ms)



Extra Long (2000 ms)

## User-Specified Reread Delay

If you want to set your own length for the reread delay, scan the barcode below, then set the delay (from 0-30,000 milliseconds) by scanning digits from the inside back cover, then scanning **Save**.



User-Specified Reread Delay

---

## Centering Window

Use the centering feature to narrow the image scanner's field of view so the image scanner reads only the barcode you want. When centering is turned on, the image scanner only reads codes that intersect or are contained within the centering window you set up. At least part of a barcode must be within the window to be decoded or output by the image scanner.

To change the left or right edge of the centering window, scan Centering On, then scan one of the following barcodes. Then scan the percent you want to shift the centering window using digits on the inside back cover of this manual. Scan **Save**. Default Centering = 40% for Left, 60% for Right.



Centering On



\* Centering Off



Left of Centering Window



Right of Centering Window

The figure below illustrates the percentage range from 1 to 100%.

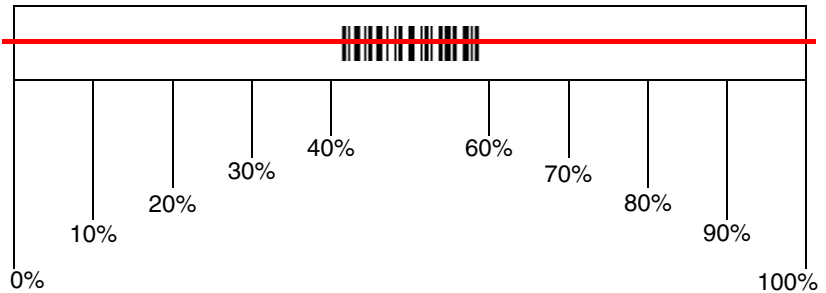

**Example:** If you have two barcodes next to one another and the centering window is set to 40% left edge and 60% right edge, only the barcode that intersects that window will be decoded.

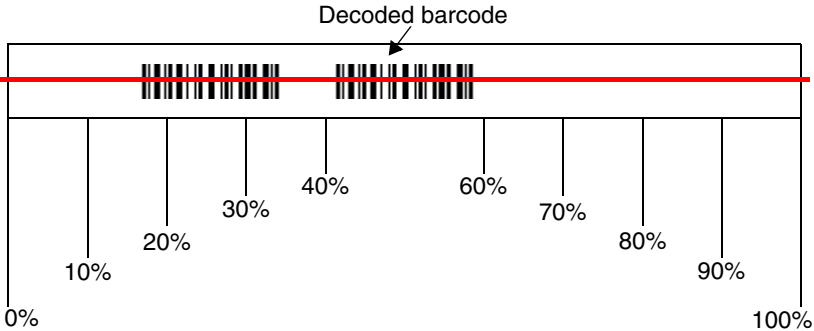

## Preferred Symbology

The 3820/3820i can be programmed to specify one symbology as a higher priority over other symbologies in situations where both bar code symbologies appear on the same label, but the lower priority symbology cannot be disabled.

For example, you may be using the imager in a retail setting to read UPC symbols, but have occasional need to read a code on a drivers license. Since some licenses have a Code 39 symbol as well as the PDF417 symbol, you can use Preferred Symbology to specify that the PDF417 symbol be read instead of the Code 39.

Preferred Symbology classifies each symbology as **high priority**, **low priority**, or as an **unspecified type**. When a low priority symbology is presented, the imager ignores it for a set period of time (see [Preferred Symbology Time-out](#) on page 3-9) while it searches for the high priority symbology. If a high priority symbology is located during this period, then that data is read immediately.

If the time-out period expires before a high priority symbology is read, the imager will read any bar code in its view (low priority or unspecified). If there is no bar code in the imager's view after the time-out period expires, then no data is reported.

*Note: A low priority symbol must be centered on the aiming pattern to be read.*

Scan a bar code below to enable or disable Preferred Symbology.



Preferred Symbology On



\* Preferred Symbology Off

---

## **High Priority Symbology**

To specify the high priority symbology, scan the High Priority Symbology bar code below. On the [Symbology Chart](#) on page A-1, find the symbology you want to set as high priority. Locate the Hex value for that symbology and scan the 2 digit hex value from the Programming Chart (inside back cover). Scan **Save** to save your selection. *Default = None*



High Priority Symbology

## **Low Priority Symbology**

To specify the low priority symbology, scan the Low Priority Symbology bar code below. On the [Symbology Chart](#) on page A-1, find the symbology you want to set as low priority. Locate the Hex value for that symbology and scan the 2 digit hex value from the Programming Chart (inside back cover).

If you want to set additional low priority symbologies, scan **FF**, then scan the 2 digit hex value from the Programming Chart for the next symbology. You can program up to 5 low priority symbologies. Scan **Save** to save your selection. *Default = None*



Low Priority Symbology

## **Preferred Symbology Time-out**

Once you have enabled Preferred Symbology and entered the high and low priority symbologies, you must set the time-out period. This is the period of time the imager will search for a high priority bar code after a low priority bar code has been encountered. Scan the bar code below, then set the delay (from 1-3,000 milliseconds) by scanning digits from the inside back cover, then scanning **Save**. *Default = 500 ms.*



Preferred Symbology Time-out

## **Preferred Symbology Default**

Scan the bar code below to set all Preferred Symbology entries to their default values.



Preferred Symbology Default

---

# Output Sequence Overview

## Require Output Sequence

When turned off, the barcode data will be output to the host as the image scanner decodes it. When turned on, all output data must conform to an edited sequence or the image scanner will not transmit the output data to the host device.

*Note: This selection is unavailable when the Multiple Symbols Selection is turned on.*

## Output Sequence Editor

This programming selection allows you to program the image scanner to output data (when scanning more than one symbol) in whatever order your application requires, regardless of the order in which the barcodes are scanned. Reading the **Default Sequence** symbol programs the image scanner to the Universal values, shown below. These are the defaults. Be **certain** you want to delete or clear all formats before you read the **Default Sequence** symbol.

*Note: You must hold the trigger while reading each barcode in a sequence.*

*Note: To make Output Sequence Editor selections, you'll need to know the code I.D., code length, and character match(es) your application requires. Use the Alphanumeric symbols (inside back cover) to read these options.*

### To Add an Output Sequence

1. Scan the **Enter Sequence** symbol (see [Require Output Sequence](#), page 3-11).
2. **Code I.D.**  
On the [Symbology Chart](#) on page A-1, find the symbology to which you want to apply the output sequence format. Locate the Hex value for that symbology and scan the 2 digit hex value from the [Programming Chart](#) inside the back cover of this manual.
3. **Length**  
Specify what length (up to 9999 characters) of data output will be acceptable for this symbology. Scan the four digit data length from the [Programming Chart](#) inside the back cover of this manual. (Note: 50 characters is entered as 0050. 9999 is a universal number, indicating all lengths.) When calculating the length, you must count any programmed prefixes, suffixes, or formatted characters as part of the length (unless using 9999).
4. **Character Match Sequences**  
On the [ASCII Conversion Chart \(Code Page 1252\)](#) on page A-2, find the Hex value that represents the character(s) you want to match. Use the [Programming Chart](#) inside the back cover of this manual to read the alphanumeric combination that represents the ASCII characters. (99 is the Universal number, indicating all characters.)



---

## 5. End Output Sequence Editor

Scan **FF** to enter an Output Sequence for an additional symbology, or **Save** to save your entries.

### Other Programming Selections

#### •Discard

This exits without saving any Output Sequence changes.

### **Output Sequence Editor**



Enter Sequence



Default Sequence

### **Require Output Sequence**

When an output sequence is **Required**, all output data must conform to an edited sequence or the image scanner will not transmit the output data to the host device. When it's **On/Not Required**, the image scanner will attempt to get the output data to conform to an edited sequence, but if it cannot, the image scanner transmits all output data to the host device as is.

When the output sequence is **Off**, the barcode data is output to the host as the image scanner decodes it.

*Note: This selection is unavailable when the Multiple Symbols Selection is turned on.*



Required



On/Not Required



\* Off

---

## Output Sequence Example

In this example, you are scanning Code 93, Code 128, and Code 39 barcodes, but you want the image scanner to output Code 39 1st, Code 128 2nd, and Code 93 3rd, as shown below.

*Note: Code 93 must be enabled to use this example.*



A - Code 39



B - Code 128



C - Code 93

You would set up the sequence editor with the following command line:

**SEQBLK62999941FF6A999942FF69999943FF**

The breakdown of the command line is shown below:

SEQBLKsequence editor start command

62 code identifier for **Code 39**

9999 code length that must match for Code 39, 9999 = all lengths

41 start character match for Code 39, 41h = "A"

FF termination string for first code

6A code identifier for **Code 128**

9999 code length that must match for Code 128, 9999 = all lengths

42 start character match for Code 128, 42h = "B"

FF termination string for second code

69 code identifier for **Code 93**

9999 code length that must match for Code 93, 9999 = all lengths

43 start character match for Code 93, 43h = "C"

FF termination string for third code

---

To program the previous example using specific lengths, you would have to count any programmed prefixes, suffixes, or formatted characters as part of the length. If you use the example on page 3-12, but assume a <CR> suffix and specific code lengths, you would use the following command line:

**SEQBLK62001241FF6A001342FF69001243FF**

The breakdown of the command line is shown below:

SEQBLK sequence editor start command  
62 code identifier for **Code 39**  
0012 A - Code 39 sample length (11) plus CR suffix (1) = 12  
41 start character match for Code 39, 41h = "A"  
FF termination string for first code  
6A code identifier for **Code 128**  
0013 B - Code 128 sample length (12) plus CR suffix (1) = 13  
42 start character match for Code 128, 42h = "B"  
FF termination string for second code  
69 code identifier for **Code 93**  
0012 C - Code 93 sample length (11) plus CR suffix (1) = 12  
43 start character match for Code 93, 43h = "C"  
FF termination string for third code

## ***Multiple Symbols***

When this programming selection is turned **On**, it allows you to read multiple symbols with a single pull of the image scanner's trigger. If you press and hold the trigger, aiming the image scanner at a series of symbols, it reads unique symbols once, beeping (if turned on) for each read. The image scanner attempts to find and decode new symbols as long as the trigger is pulled. When this programming selection is turned **Off**, the image scanner will only read the symbol closest to the aiming beam.



Multiple Symbols On



\* Multiple Symbols Off

---

## No Read

With No Read turned **On**, the image scanner sends an “NR” to the host if you pull and release the trigger without reading a code (e.g., bad barcode). If No Read is turned **Off**, the “NR” will not be sent to the host.



No Read On



\* No Read Off

If you want a different notation than “NR,” for example, “Error,” or “Bad Code,” you can edit the output message using the [Data Formatter](#) (page 5-4). The hex code for the No Read symbol is 9C.

## Video Reverse

Video Reverse is used to allow the image scanner to read barcodes that are inverted. The “Off” barcode below is an example of this type of barcode.

*Note: If additional menuing is required, Video Reverse must be disabled to read the menu barcodes and then re-enabled after menuing is completed.*



Video Reverse On



\* Video Reverse Off

## Prefix/Suffix Overview

When a barcode is scanned, additional information is sent to the host computer along with the barcode data. This group of barcode data and additional, user-defined data is called a “message string.” The selections in this section are used to build the user-defined data into the message string.

Prefix and Suffix characters are data characters that can be sent before and after scanned data. You can specify if they should be sent with all symbologies, or only with specific symbologies. The following illustration shows the breakdown of a message string:

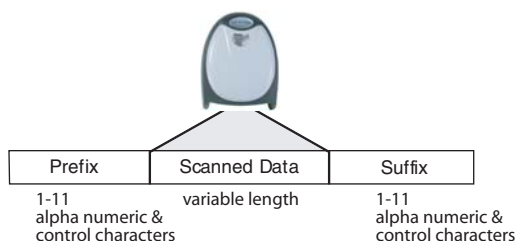

### Points to Keep In Mind

- It is not necessary to build a message string. The selections in this chapter are only used if you wish to alter the default settings. *Default prefix = None. Default suffix = None.*
- A prefix or suffix may be added or cleared from one symbology or all symbologies.
- You can add any prefix or suffix from the [ASCII Conversion Chart \(Code Page 1252\)](#) on page A-2, plus Code I.D. and AIM I.D.
- You can string together several entries for several symbologies at one time.
- Enter prefixes and suffixes in the order in which you want them to appear on the output.
- When setting up for specific symbologies (as opposed to all symbologies), the specific symbology ID value counts as an added prefix or suffix character.

### To Add a Prefix or Suffix:

- Step 1.** Scan the **Add Prefix** or **Add Suffix** symbol ([page 4-3](#)).
- Step 2.** Determine the 2 digit Hex value from the Symbology Chart (included in the [Appendix A](#)) for the symbology to which you want to apply the prefix or suffix. For example, for Code 128, Code ID is “j” and Hex ID is “6A”.
- Step 3.** Scan the 2 hex digits from the [Programming Chart](#) inside the back cover of this manual or scan **9, 9** for all symbologies.

---

**Step 4.** Determine the hex value from the [ASCII Conversion Chart \(Code Page 1252\)](#) on page A-2, for the prefix or suffix you wish to enter.

**Step 5.** Scan the 2 digit hex value from the [Programming Chart](#) inside the back cover of this manual.

**Step 6.** Repeat Steps 4 and 5 for every prefix or suffix character.

**Step 7.** To add the Code I.D., scan **5, C, 8, 0**.

To add AIM I.D., scan **5, C, 8, 1**.

To add a backslash (\), scan **5, C, 5, C**.

*Note: To add a backslash (\) as in Step 7, you must scan 5C twice – once to create the leading backslash and then to create the backslash itself.*

**Step 8.** Scan **Save** to exit and save, or scan **Discard** to exit without saving.

Repeat Steps 1-6 to add a prefix or suffix for another symbology.

### ***Example: Add a Suffix to a specific symbology***

To send a CR (carriage return) Suffix for UPC only:

**Step 1.** Scan **Add Suffix**.

**Step 2.** Determine the 2 digit hex value from the Symbology Chart (included in the [Appendix A](#)) for UPC.

**Step 3.** Scan **6, 3** from the [Programming Chart](#) inside the back cover of this manual.

**Step 4.** Determine the hex value from the [ASCII Conversion Chart \(Code Page 1252\)](#) on page A-2, for the CR (carriage return).

**Step 5.** Scan **0, D** from the [Programming Chart](#) inside the back cover of this manual.

**Step 6.** Scan **Save**, or scan **Discard** to exit without saving.

### ***To Clear One or All Prefixes or Suffixes:***

You can clear a single prefix or suffix, or clear all prefixes/suffixes for a symbology. When you Clear One Prefix (Suffix), the specific character you select is deleted from the symbology you want. When you Clear All Prefixes (Suffixes), all the prefixes or suffixes for a symbology are deleted.

**Step 1.** Scan the **Clear One Prefix** or **Clear One Suffix** symbol.

**Step 2.** Determine the 2 digit Hex value from the Symbology Chart (included in the [Appendix A](#)) for the symbology from which you want to clear the prefix or suffix.

---

**Step 3.** Scan the 2 digit hex value from the [Programming Chart](#) inside the back cover of this manual or scan **9, 9** for all symbologies.

Your change is automatically saved.

***To Add a Carriage Return Suffix to All Symbologies***

Scan the following barcode if you wish to add a carriage return suffix to all symbologies at once. This action first clears all current suffixes, then programs a carriage return suffix for all symbologies.



Add CR Suffix  
All Symbologies

***Prefix Selections***



Add Prefix



Clear One Prefix



Clear All Prefixes

---

## Suffix Selections



Add Suffix



Clear One Suffix



Clear All Suffixes

## Function Code Transmit

When this selection is enabled and function codes are contained within the scanned data, the image scanner transmits the function code to the terminal. Charts of these function codes are provided in [Supported Interface Keys](#) starting on [page 7-3](#). When the image scanner is in keyboard wedge mode, the scan code is converted to a key code before it is transmitted. *Default = Enable.*



\* Enable



Disable

## Intercharacter, Interfunction, and Intermessage Delays

Some terminals drop information (characters) if data comes through too quickly. Intercharacter, interfunction, and intermessage delays slow the transmission of data, increasing data integrity.

Each delay is composed of a 5 millisecond step. You can program up to 99 steps (of 5 ms each) for a range of 0-495 ms.



---

## Intercharacter Delay

An intercharacter delay of up to 495 milliseconds may be placed between the transmission of each character of scanned data. Scan the **Intercharacter Delay** barcode below, then scan the number of milliseconds and the **SAVE** barcode using the [Programming Chart](#) inside the back cover of this manual.

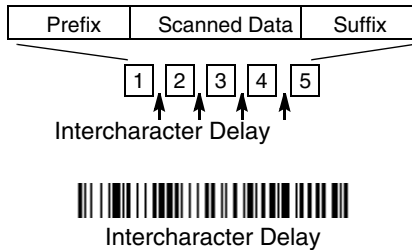

To remove this delay, scan the **Intercharacter Delay** barcode, then set the number of steps to 0. Scan the **SAVE** barcode using the [Programming Chart](#) inside the back cover of this manual.

*Note: Intercharacter delays are not supported in USB serial emulation.*

## User Specified Intercharacter Delay

An intercharacter delay of up to 495 milliseconds may be placed after the transmission of a particular character of scanned data. Scan the **Delay Length** barcode below, then scan the number of milliseconds and the **SAVE** barcode using the [Programming Chart](#) inside the back cover of this manual.

Next, scan the **Character to Trigger Delay** barcode, then the 2-digit hex value for the ASCII character that will trigger the delay [ASCII Conversion Chart \(Code Page 1252\)](#) on page A-2.



Delay Length



Character to Trigger Delay

To remove this delay, scan the **Delay Length** barcode, and set the number of steps to 0. Scan the **SAVE** barcode using the [Programming Chart](#) inside the back cover of this manual.

---

### Interfunction Delay

An interfunction delay of up to 495 milliseconds may be placed between the transmission of each segment of the message string. Scan the **Interfunction Delay** barcode below, then scan the number of milliseconds and the **SAVE** barcode using the [Programming Chart](#) inside the back cover of this manual.

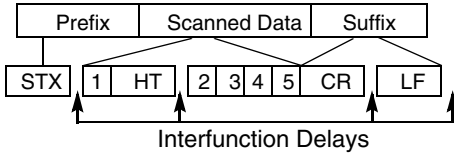

Interfunction Delay

To remove this delay, scan the **Interfunction Delay** barcode, then set the number of steps to 0. Scan the **SAVE** barcode using the [Programming Chart](#) inside the back cover of this manual.

### Intermessage Delay

An intermessage delay of up to 495 milliseconds may be placed between each scan transmission. Scan the **Intermessage Delay** barcode below, then scan the number of milliseconds and the **SAVE** barcode using the [Programming Chart](#) inside the back cover of this manual.

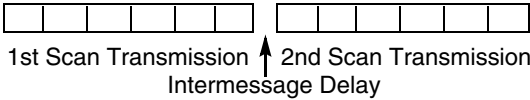

Intermessage Delay

To remove this delay, scan the **Intermessage Delay** barcode, then set the number of steps to 0. Scan the **SAVE** barcode using the [Programming Chart](#) inside the back cover of this manual.

## Data Format Editor Introduction

You may use the Data Format Editor to change the image scanner's output. For example, you can use the Data Format Editor to insert characters at certain points in barcode data as it is scanned. The selections in the following pages are used only if you wish to alter the output. *Default Data Format setting = None.*

Normally, when you scan a barcode, it is output automatically; however when you do a format, you must use a "send" command (see [Send Commands](#) on page 5-2) within the format program to output data.

Multiple formats may be programmed into the image scanner. They are stacked in the order in which they are entered. However, the following list presents the order in which formats are applied:

1. Specific Term ID, Actual Code ID, Actual Length
2. Specific Term ID, Actual Code ID, Universal Length
3. Specific Term ID, Universal Code ID, Actual Length
4. Specific Term ID, Universal Code ID, Universal Length
5. Universal Term ID, Actual Code ID, Actual Length
6. Universal Term ID, Actual Code ID, Universal Length
7. Universal Term ID, Universal Code ID, Actual Length
8. Universal Term ID, Universal Code ID, Universal Length

If you have changed data format settings, and wish to clear all formats and return to the factory defaults, scan the **Default Data Format** code on [page 5-4](#).

### To Add a Data Format

**Step 1.** Scan the **Enter Data Format** symbol ([page 5-4](#)).

**Step 2. Primary/Alternate Format**

Determine if this will be your primary data format, or one of 3 alternate formats. (Alternate formats allow you "single shot" capability to scan one barcode using a different data format. After the one barcode has been read, the image scanner reverts to the primary data format. See [page 5-5](#).) If you are programming the primary format, scan **0** using the [Programming Chart](#) inside the back cover of this manual. If you are programming an alternate format, scan **1**, **2**, or **3**, depending on the alternate format you are programming.

**Step 3. Terminal Type**

Refer to the Supported Terminals Chart ([page 2-2](#)) and locate the Terminal ID number for your PC. Scan three numeric barcodes on the inside back cover to program the image scanner for your terminal ID (you must enter 3 digits). For example, scan **0 0 3** for an AT wedge.

*Note: The wildcard for all terminal types is 099.*

---

#### Step 4. Code I.D.

In the [Appendix A](#), find the symbology to which you want to apply the data format. Locate the Hex value for that symbology and scan the 2 digit hex value from the [Programming Chart](#) inside the back cover of this manual.

#### Step 5. Length

Specify what length (up to 9999 characters) of data will be acceptable for this symbology. Scan the four digit data length from the [Programming Chart](#) inside the back cover of this manual. (Note: 50 characters is entered as 0050. 9999 is a universal number, indicating all lengths.)

#### Step 6. Editor Commands

Refer to the Format Editor Commands Chart ([page 5-2](#)). Scan the symbols that represent the command you want to enter. 94 alphanumeric characters may be entered for each symbology data format.

**Step 7.** Scan **Save** from the [Programming Chart](#) inside the back cover of this manual to save your entries.

### Other Programming Selections

- **Clear One Data Format**

This deletes one data format for one symbology. If you are clearing the primary format, scan **0** from the [Programming Chart](#) inside the back cover of this manual. If you are clearing an alternate format, scan **1**, **2**, or **3**, depending on the alternate format you are clearing. Scan the Terminal Type (refer to the Supported Terminals Chart on [page 2-2](#)), Code I.D. (refer to the [Symbology Chart](#) on page A-1), and the barcode data length for the specific data format that you want to delete. All other formats remain unaffected.

- **Save** from the [Programming Chart](#) inside the back cover of this manual  
This exits, saving any Data Format changes.

- **Discard** from the [Programming Chart](#) inside the back cover of this manual  
This exits without saving any Data Format changes.

### Data Format Editor Commands

#### Send Commands

F1 Send all characters followed by “xx” key or function code, starting from current cursor position. **Syntax = F1xx** (xx stands for the hex value for an ASCII code, see [ASCII Conversion Chart \(Code Page 1252\)](#) on page A-2.)

F2 Send “nn” characters followed by “xx” key or function code, starting from current cursor position. **Syntax = F2nnxx** (nn stands for the numeric value (00-99) for the number of characters and xx stands for the hex value for an ASCII code. See [ASCII Conversion Chart \(Code Page 1252\)](#) on page A-2.)

F3 Send up to but not including “ss” character (Search and Send) starting from current cursor position, leaving cursor pointing to “ss” character followed by “xx” key or function code. **Syntax = F3ssxx** (ss and xx both stand for the hex values for ASCII codes, see [ASCII Conversion Chart \(Code Page 1252\)](#) on page A-2.)

F4 Send “xx” character “nn” times (Insert) leaving cursor in current cursor position. **Syntax = F4xxnn** (xx stands for the hex value for an ASCII code, see

---

[ASCII Conversion Chart \(Code Page 1252\)](#) on page A-2, and nn is the numeric value (00-99) for the number of times it should be sent.)

- E9 Send all but the last “nn” characters, starting from the current cursor position. **Syntax = E9nn** (nn is the numeric value (00-99) for the number of characters that will not be sent at the end of the message.)

### **Move Commands**

- F5 Move the cursor ahead “nn” characters from current cursor position. **Syntax = F5nn** (nn stands for the numeric value (00-99) for the number of characters the cursor should be moved ahead.)
- F6 Move the cursor back “nn” characters from current cursor position. **Syntax = F6nn** (nn stands for the numeric value (00-99) for the number of characters the cursor should be moved back.)
- F7 Move the cursor to the beginning of the data string. **Syntax = F7**.
- EA Move the cursor to the end of the data string. **Syntax = EA**

### **Search Commands**

- F8 Search ahead for “xx” character from current cursor position, leaving cursor pointing to “xx” character. **Syntax = F8xx** (xx stands for the hex value for an ASCII code, see [ASCII Conversion Chart \(Code Page 1252\)](#) on page A-2.)
- F9 Search back for “xx” character from current cursor position, leaving cursor pointing to “xx” character. **Syntax = F9xx** (xx stands for the hex value for an ASCII code, see [ASCII Conversion Chart \(Code Page 1252\)](#) on page A-2.)
- E6 Search ahead for the first non “xx” character from the current cursor position, leaving cursor pointing to non “xx” character. **Syntax = E6xx** (xx stands for the hex value for an ASCII code, see [ASCII Conversion Chart \(Code Page 1252\)](#) on page A-2.)
- E7 Search back for the first non “xx” character from the current cursor position, leaving cursor pointing to non “xx” character. **Syntax = E7xx** (xx stands for the hex value for an ASCII code, see [ASCII Conversion Chart \(Code Page 1252\)](#) on page A-2.)

### **Miscellaneous Commands**

- FB Suppress all occurrences of up to 15 different characters, starting at the current cursor position, as the cursor is advanced by other commands. When the FC command is encountered, the suppress function is terminated. The cursor is not moved by the FB command. **Syntax = FBnnxxyy** . **zz** where nn is a count of the number of suppressed characters in the list and xxyy .. zz is the list of characters to be suppressed. (xx stands for the hex value for an ASCII code, see [ASCII Conversion Chart \(Code Page 1252\)](#) on page A-2.)
- FC Disables suppress filter and clear all suppressed characters. **Syntax = FC**.
- E4 Replaces up to 15 characters in the data string with user specified characters. Replacement continues until the E5 command is encountered. **Syntax = E4nnxx<sub>1</sub>xx<sub>2</sub>yy<sub>1</sub>yy<sub>2</sub>...zz<sub>1</sub>zz<sub>2</sub>** where nn is the total count of both characters to be replaced plus replacement characters; xx<sub>1</sub> defines charac-

---

ters to be replaced and  $xx_2$  defines replacement characters, continuing through  $zz_1$  and  $zz_2$ .

- E5 Terminates character replacement. **Syntax = E5.**
- FE Compare character in current cursor position to the character “xx.” If characters are equal, increment cursor. If characters are not equal, no format match. **Syntax = FExx** (xx stands for the hex value for an ASCII code, see [ASCII Conversion Chart \(Code Page 1252\)](#) on page A-2.)
- EC Check to make sure there is an ASCII number at the current cursor position. If character is not numeric, format is aborted. **Syntax = EC.**
- ED Check to make sure there is a non-numeric ASCII character at the current cursor position. If character is numeric, format is aborted. **Syntax = ED.**

### Data Format Editor



Enter Data Format



\* Default Data Format



Clear One Data Format



Clear All Data Formats



Save



Discard

### Data Formatter

When Data Formatter is turned off, the barcode data is output to the host as read (including prefixes and suffixes). Choose one of the following options. *Default = Data Formatter On.*



\* Data Formatter On,  
but Not Required



Data Formatter Off

---

When Data Formatter is required, all input data must conform to an edited format or the image scanner does not transmit the input data to the host device.



Data Format On, Format Required

***Alternate Data Formats***

Alternate formats allow you “single shot” capability to scan one barcode using a different data format than your primary format. When data formats are programmed (see [page 5-1](#)), you must input whether you are programming the primary format, or an alternate format numbered 1, 2, or 3.

An alternate format is initiated by scanning one of the 3 alternate format barcodes below. The image scanner will scan the next barcode, formatting the data with the selected alternate format, then revert immediately to the primary format.



Alternate Data Format 1



Alternate Data Format 2



Alternate Data Format 3





## Introduction

This programming section contains the following menu selections. Refer to [Chapter 10](#) for settings and defaults.

- All Symbologies
- China Post Code
- Codabar
- Codablock F
- Code 11
- Code 16K
- Code 39
- Code 32 Pharmaceutical (PARAF)
- Code 39
- Code 49
- Code 93
- Code 128
- EAN/JAN 8
- GS1 DataBar Limited
- Interleaved 2 of 5
- Korea Post Code
- Matrix 2 of 5
- UPC-A/EAN-13 with Extended Coupon Code
- MSI
- Plessey Code
- PosiCode A and B
- Straight 2 of 5 IATA (two-bar start/stop)
- Straight 2 of 5 Industrial
- Telepen
- Trioptic Code
- UPC A
- UPC E0 and UPC E1

## All Symbologies

If you want to decode all the symbologies allowable for your image scanner, scan the **All Symbologies On** code. If on the other hand, you want to decode only a particular symbology, scan All Symbologies Off followed by the On symbol for that particular symbology.



All Symbologies On



All Symbologies Off

---

## ***Message Length***

You are able to set the valid reading length of some of the barcode symbologies. If the data length of the scanned barcode doesn't match the valid reading length, the image scanner will issue an error beep. You may wish to set the same value for minimum and maximum length to force the image scanner to read fixed length barcode data. This helps reduce the chances of a misread.

**EXAMPLE:** Decode only those barcodes with a count of 9-20 characters.  
Min. length = 09      Max. length = 20

**EXAMPLE:** Decode only those barcodes with a count of 15 characters.  
Min. length = 15      Max. length = 15

For a value other than the minimum and maximum message length defaults, scan the barcodes included in the explanation of the symbology, then scan the digit value of the message length and **Save** barcodes on the [Programming Chart](#) inside the back cover of this manual. The minimum and maximum lengths and the defaults are included with the respective symbologies.

---

## Codabar

<Default All Codabar Settings>



## Codabar



\* On



Off

## Codabar Start/Stop Characters

Start/Stop characters identify the leading and trailing ends of the barcode. You may either transmit, or not transmit Start/Stop characters. *Default = Don't Transmit.*



Transmit



\* Don't Transmit

## Codabar Check Character

Codabar check characters are created using different “modulos.” You can program the image scanner to read only Codabar barcodes with Modulo 16 check characters. *Default = No Check Character.*

**No Check Character** indicates that the image scanner reads and transmits barcode data with or without a check character.

When Check Character is set to **Validate and Transmit**, the image scanner will only read Codabar barcodes printed with a check character, and will transmit this character at the end of the scanned data.

---

When Check Character is set to **Validate, but Don't Transmit**, the unit will only read Codabar barcodes printed **with** a check character, but will not transmit the check character with the scanned data.



\* No Check Character



Validate Modulo 16, but Don't Transmit



Validate Modulo 16 and Transmit

### Codabar Concatenation

Codabar supports symbol concatenation. When you enable concatenation, the image scanner looks for a Codabar symbol having a “D” start character, adjacent to a symbol having a “D” stop character. In this case the two messages are concatenated into one with the “D” characters omitted. *Default = On.*



Select Require to prevent the image scanner from decoding a single “D” Codabar symbol without its companion. This selection has no effect on Codabar symbols without Stop/Start D characters.



On



\* Off



Require

---

### **Codabar Message Length**

Scan the barcodes below to change the message length. Refer to [Message Length](#) on page 6-2 for additional information. Minimum and Maximum lengths = 2-60. Minimum Default = 4, Maximum Default = 60.



Minimum Message Length



Maximum Message Length

---

---

### **Code 39**

< Default All Code 39 Settings >



### **Code 39**



\* On



Off

### **Code 39 Start/Stop Characters**

Start/Stop characters identify the leading and trailing ends of the barcode. You may either transmit, or not transmit Start/Stop characters. *Default = Don't Transmit.*



Transmit



\* Don't Transmit

---

---

## Code 39, continued

### Code 39 Check Character

**No Check Character** indicates that the image scanner reads and transmits barcode data with or without a check character.

When Check Character is set to **Validate, but Don't Transmit**, the unit only reads Code 39 barcodes printed with a check character, but will not transmit the check character with the scanned data.

When Check Character is set to **Validate and Transmit**, the image scanner only reads Code 39 barcodes printed with a check character, and will transmit this character at the end of the scanned data. *Default = No Check Character.*



\* No Check Character



Validate, but Don't Transmit



Validate and Transmit

### Code 39 Message Length

Scan the barcodes below to change the message length. Refer to [Message Length](#) on page 6-2 for additional information. Minimum and Maximum lengths = 0-48. Minimum Default = 0, Maximum Default = 48.



Minimum Message Length



Maximum Message Length

---

## Code 39, continued

### Code 39 Append

This function allows the image scanner to append the data from several Code 39 barcodes together before transmitting them to the host computer. When this function is enabled, the image scanner stores those Code 39 barcodes that start with a space (excluding the start and stop symbols), and does not immediately transmit the data. The image scanner stores the data in the order in which the barcodes are read, deleting the first space from each. The image scanner transmits the appended data when it reads a Code 39 barcode that starts with a character other than a space. *Default = Off.*



On



\* Off

### Code 32 Pharmaceutical (PARAF)

Code 32 Pharmaceutical is a form of the Code 39 symbology used by Italian pharmacies. This symbology is also known as PARAF.

*Note: Trioptic Code must be turned off to scan Code 32 Pharmaceutical codes.*



On



\* Off

## Full ASCII

If Full ASCII Code 39 decoding is enabled, certain character pairs within the barcode symbol will be interpreted as a single character. For example: \$V will be decoded as the ASCII character SYN, and /C will be decoded as the ASCII character #. *Default = On.*

NUL %U	DLE \$P	SP SPACE	0 0	@ %V	P P	' %W	p +P	
SOH \$A	DC1 \$Q	! /A	1 1	A A	Q Q	a +A	q +Q	
STX \$B	DC2 \$R	" /B	2 2	B B	R R	b +B	r +R	
ETX \$C	DC3 \$S	# /C	3 3	C C	S S	c +C	s +S	
EOT \$D	DC4 \$T	\$ /D	4 4	D D	T T	d +D	t +T	
ENQ \$E	NAK \$U	% /E	5 5	E E	U U	e +E	u +U	
ACK \$F	SYN \$V	& /F	6 6	F F	V V	f +F	v +V	
BEL \$G	ETB \$W	' /G	7 7	G G	W W	g +G	w +W	
BS \$H	CAN \$X	( /H	8 8	H H	X X	h +H	x +X	
HT \$I	EM \$Y	) /I	9 9	I I	Y Y	i +I	y +Y	
LF \$J	SUB \$Z	* /J	:	/Z	J J	Z Z	j +J	z +Z
VT \$K	ESC %A	+ /K	;	%F	K K	[ %K	k +K	{ %P
FF \$L	FS %B	, /L	<	%G	L L	\ %L	l +L	l %Q
CR \$M	GS %C	- -	=	%H	M M	] %M	m +M	} %R
SO \$N	RS %D	. .	>	%I	N N	^ %N	n +N	~ %S
SI \$O	US %E	/ /O	?	%J	O O	_ %O	o +O	DEL %T

Character pairs /M and /N decode as a minus sign and period respectively. Character pairs /P through /Y decode as 0 through 9.



Full ASCII On



\* Full ASCII Off



---

## Code 39 Code Page

Code pages define the mapping of character codes to characters. If the data received does not display with the proper characters, it may be because the barcode being scanned was created using a code page that is different from the one the host program is expecting. If this is the case, scan the barcode below, select the code page with which the barcodes were created from the chart, [Code Page Mapping of Printed Barcodes](#) on page A-4, and scan the value and the **SAVE** barcode from the [Programming Chart](#) inside the back cover of this manual. The data characters should then appear properly.



Code 39 Code Page

---

---

## Interleaved 2 of 5

< *Default All Interleaved 2 of 5 Settings* >



---

## Interleaved 2 of 5



\* On



Off

## Check Digit

**No Check Digit** indicates that the image scanner reads and transmits barcode data with or without a check digit.

When Check Digit is set to **Validate, but Don't Transmit**, the unit only reads Interleaved 2 of 5 barcodes printed with a check digit, but will not transmit the check digit with the scanned data.



When Check Digit is set to **Validate and Transmit**, the image scanner only reads Interleaved 2 of 5 barcodes printed with a check digit, and will transmit this digit at the end of the scanned data. *Default = No Check Digit.*



\* No Check Digit



Validate, but Don't Transmit



Validate and Transmit

***Interleaved 2 of 5 Message Length***

Scan the barcodes below to change the message length. Refer to [Message Length](#) on page 6-2 for additional information. Minimum and Maximum lengths = 2-80. Minimum Default = 4, Maximum Default = 80.



Minimum Message Length



Maximum Message Length



---

## Code 93

< Default All Code 93 Settings >



## Code 93



\* On



Off

## Code 93 Message Length

Scan the barcodes below to change the message length. Refer to [Message Length](#) on page 6-2 for additional information. Minimum and Maximum lengths = 0-80. Minimum Default = 0, Maximum Default = 80.



Minimum Message Length



Maximum Message Length

## Code 93 Code Page

Code pages define the mapping of character codes to characters. If the data received does not display with the proper characters, it may be because the barcode being scanned was created using a code page that is different from the one the host program is expecting. If this is the case, scan the barcode below, select the code page with which the barcodes were created from the chart, [Code Page Mapping of Printed Barcodes](#) on page A-4, and scan the value and the **SAVE** barcode from the [Programming Chart](#) inside the back cover of this manual. The data characters should then appear properly.



Code 93 Code Page

---

## ***Straight 2 of 5 Industrial (three-bar start/stop)***

*<Default All Straight 2 of 5 Settings>*



---

## ***Straight 2 of 5 Industrial***



On



\* Off

## ***Straight 2 of 5 Industrial Message Length***

Scan the barcodes below to change the message length. Refer to [Message Length](#) on page 6-2 for additional information. Minimum and Maximum lengths = 1-48. Minimum Default = 4, Maximum Default = 48.



Minimum Message Length



Maximum Message Length

---

---

## ***Straight 2 of 5 IATA (two-bar start/stop)***

*<Default All Straight 2 of 5 IATA Settings>*



---

## ***Straight 2 of 5 IATA, continued***



On



\* Off

### ***Straight 2 of 5 IATA Message Length***

Scan the barcodes below to change the message length. Refer to [Message Length](#) on page 6-2 for additional information. Minimum and Maximum lengths = 1-48. Minimum Default = 4, Maximum Default = 48.



Minimum Message Length



Maximum Message Length

---

## ***Matrix 2 of 5***

*<Default All Matrix 2 of 5 Settings>*



---

## ***Matrix 2 of 5***



On



\* Off

---

### **Matrix 2 of 5 Message Length**

Scan the barcodes below to change the message length. Refer to [Message Length](#) on page 6-2 for additional information. Minimum and Maximum lengths = 1-80. Minimum Default = 4, Maximum Default = 80.



Minimum Message Length



Maximum Message Length

---

### **Code 11**

*<Default All Code 11 Settings>*



---

### **Code 11**



On



\* Off

### **Check Digits Required**

This option sets whether 1 or 2 check digits are required with Code 11 barcodes. *Default = Two Check Digits.*



One Check Digit



\* Two Check Digits

---

---

## *Code 11, continued*

### **Code 11 Message Length**

Scan the barcodes below to change the message length. Refer to [Message Length](#) on page 6-2 for additional information. Minimum and Maximum lengths = 1-80. Minimum Default = 4, Maximum Default = 80.



Minimum Message Length



Maximum Message Length

---

---

## **Code 128**

*<Default All Code 128 Settings>*



## **Code 128**



\* On



Off

---

## Code 128, continued

### ISBT 128 Concatenation

In 1994 the International Society of Blood Transfusion (ISBT) ratified a standard for communicating critical blood information in a uniform manner. The use of ISBT formats requires a paid license. The ISBT 128 Application Specification describes 1) the critical data elements for labeling blood products, 2) the current recommendation to use Code 128 due to its high degree of security and its space-efficient design, 3) a variation of Code 128 that supports concatenation of neighboring symbols, and 4) the standard layout for barcodes on a blood product label. Use the barcodes below to turn concatenation on or off. *Default = Off.*



On



\* Off

### Code 128 Message Length

Scan the barcodes below to change the message length. Refer to [Message Length](#) on page 6-2 for additional information. Minimum and Maximum lengths = 0-80. Minimum Default = 0, Maximum Default = 80.



Minimum Message Length



Maximum Message Length

### Code 128 Code Page

Code pages define the mapping of character codes to characters. If the data received does not display with the proper characters, it may be because the barcode being scanned was created using a code page that is different from the one the host program is expecting. If this is the case, scan the barcode below, select the code page with which the barcodes were created from the chart, [Code Page Mapping of Printed Barcodes](#) on page A-4, and scan the value and the **SAVE** barcode from the [Programming Chart](#) inside the back cover of this manual. The data characters should then appear properly.



Code 128 Code Page



---

## Code 128 Function Code Transmit

By default, Code 128 function codes are not transmitted with Code 128 barcode data. However, if you wish to transmit Code 128 function codes with the barcode data, scan the **Function Codes On** barcode, below.



\* Function Codes Off



Function Codes On

---

---

## Telepen

<Default All Telepen Settings>



## Telepen



On



\* Off

## Telepen Output

Using AIM Telepen Output, the image scanner reads symbols with start/stop pattern 1 and decodes them as standard full ASCII (start/stop pattern 1). When Original Telepen Output is selected, the image scanner reads symbols with start/stop pattern 1 and decodes them as compressed numeric with optional full ASCII (start/stop pattern 2). *Default = AIM Telepen Output.*



\* AIM Telepen Output



Original Telepen Output

---

---

### **Telepen Message Length**

Scan the barcodes below to change the message length. Refer to [Message Length](#) on page 6-2 for additional information. Minimum and Maximum lengths = 1-60. Minimum Default = 1, Maximum Default = 60.



Minimum Message Length



Maximum Message Length

---

---

### **UPC A**

*<Default All UPC A Settings>*



### **UPC A**



\* On



Off

### **UPC A Check Digit**

This selection allows you to specify whether the check digit should be transmitted at the end of the scanned data or not. Default = On.



\* On



Off

---

---

## **UPC A Number System**

The numeric system digit of a U.P.C. symbol is normally transmitted at the beginning of the scanned data, but the unit can be programmed so it will not transmit it. *Default = On.*



\* On



Off

## **UPC A Addenda**

This selection adds 2 or 5 digits to the end of all scanned UPC A data. *Default = Off for both 2 Digit and 5 Digit Addenda.*



2 Digit Addenda On



\* 2 Digit Addenda Off



5 Digit Addenda On



\* 5 Digit Addenda Off

## **UPC A Addenda Required**

When Addenda Required is set to on, the image scanner will only read UPC A barcodes that have addenda. *Default = Not Required.*



Required



\* Not Required

---

### ***UPC A Addenda Separator***

When this feature is on, there is a space between the data from the barcode and the data from the addenda. When turned off, there is no space.  
*Default = On.*



\* On



Off

### ***UPC-A/EAN-13 with Extended Coupon Code***

Use the following codes to enable or disable UPC-A and EAN-13 with Extended Coupon Code. *Default = On.*



\* On



Off

---

---

### ***UPC E***

*<Default All UPC E Settings>*



---

## ***UPC E0 and UPC E1***

Most U.P.C. barcodes lead with the 0 number system. For these codes, use the UPC E0 selection. If you need to read codes that lead with the 1 number system, use the UPC E1 selection. *Default = On (UPC E0) and Off (UPC E1).*



\* UPC E0 On



UPC E1 On



UPC E0 Off



\* UPC E1 Off

## ***UPC E0 and UPC E1 Expand***

UPC E Expand expands the UPC E code to the 12 digit, UPC A format. *Default = Off.*



On



\* Off

## ***UPC E0 and UPC E1 Addenda Required***

When Addenda Required is set to on, the image scanner will only read UPC E barcodes that have addenda. *Default = Not Required.*



Required



\* Not Required

---

### **UPC E0 and UPC E1 Addenda Separator**

When this feature is on, there is a space between the data from the barcode and the data from the addenda. When turned off, there is no space. *Default = On.*



\* On



Off

### **UPC E0 Check Digit**

Check Digit specifies whether the check digit should be transmitted at the end of the scanned data or not. *Default = On.*



\* On



Off

### **UPC E0 Number System**

The numeric system digit of a U.P.C. symbol is normally transmitted at the beginning of the scanned data, but the unit can be programmed so it will not transmit it. *Default = On.*



\* On



Off

---

## UPC E0 Addenda

This selection adds 2 or 5 digits to the end of all scanned UPC E data.  
*Default = Off for both 2 Digit Addenda and 5 Digit Addenda.*



2 Digit Addenda On



\* 2 Digit Addenda Off



5 Digit Addenda On



\* 5 Digit Addenda Off

---

## EAN/JAN 13

<Default All EAN/JAN Settings>



## EAN/JAN 13



\* On



Off

## EAN/JAN 13 Check Digit

This selection allows you to specify whether the check digit should be transmitted at the end of the scanned data or not. *Default = On.*



\* On



Off

---

---

### ***EAN/JAN 13 Addenda***

This selection adds 2 or 5 digits to the end of all scanned EAN/JAN 13 data. *Default = Off for both 2 Digit and 5 Digit Addenda.*



2 Digit Addenda On



\* 2 Digit Addenda Off



5 Digit Addenda On



\* 5 Digit Addenda Off

### ***EAN/JAN 13 Addenda Required***

When Addenda Required is set to on, the image scanner will only read EAN/JAN 13 barcodes that have addenda. *Default = Not Required.*



Required



\* Not Required

### ***EAN/JAN 13 Addenda Separator***

When this feature is on, there is a space between the data from the barcode and the data from the addenda. When turned off, there is no space. *Default = On.*



\* On



Off

*Note: If you want to enable or disable EAN13 with Extended Coupon Code, refer to [UPC-A/EAN-13 with Extended Coupon Code](#) on page 6-20.*



---

### **ISBN Translate**

This selection causes EAN-13 Bookland symbols to be translated into their equivalent ISBN number format. *Default = Off.*



On



\* Off

---

### **EAN/JAN 8**

<Default All EAN/JAN 8 Settings>



---

### **EAN/JAN 8**



\* On



Off

### **EAN/JAN 8 Check Digit**

This selection allows you to specify whether the check digit should be transmitted at the end of the scanned data or not. *Default = On.*



\* On



Off

---

---

### ***EAN/JAN 8 Addenda***

This selection adds 2 or 5 digits to the end of all scanned EAN/JAN 8 data.  
*Default = Off for both 2 Digit and 5 Digit Addenda.*



2 Digit Addenda On



\* 2 Digit Addenda Off



5 Digit Addenda On



\* 5 Digit Addenda Off

### ***EAN/JAN 8 Addenda Required***

When Addenda Required is set to on, the image scanner will only read EAN/JAN 8 barcodes that have addenda. *Default = Not Required.*



Required



\* Not Required

### ***EAN/JAN 8 Addenda Separator***

When this feature is on, there is a space between the data from the barcode and the data from the addenda. When turned off, there is no space.  
*Default = On.*



\* On



Off

---

---

---

## MSI

<Default All MSI Settings>



---

## MSI



On



\* Off

### MSI Check Character

Different types of check characters are used with MSI barcodes. You can program the image scanner to read MSI barcodes with Type 10 check characters. *Default = Validate Type 10, but Don't Transmit.*

When Check Character is set to **Validate and Transmit**, the image scanner will only read MSI barcodes printed with the specified type check character, and will transmit this character at the end of the scanned data.

When Check Character is set to **Validate, but Don't Transmit**, the unit will only read MSI barcodes printed with the specified type check character, but will not transmit the check character with the scanned data.



\* Validate Type 10, but Don't  
Transmit



Validate Type 10 and Transmit

### MSI Message Length

Scan the barcodes below to change the message length. Refer to [Message Length](#) on page 6-2 for additional information. Minimum and Maximum lengths = 4-48. Minimum Default = 4, Maximum Default = 48.



Minimum Message Length



Maximum Message Length

---

## ***Plessey Code***

*<Default All Plessey Code Settings>*



---

## ***Plessey Code***



On



\* Off

## ***Plessey Message Length***

Scan the barcodes below to change the message length. Refer to [Message Length](#) on page 6-2 for additional information. Minimum and Maximum lengths = 4-48. Minimum Default = 4, Maximum Default = 48.



Minimum Message Length



Maximum Message Length

---

## ***GS1 DataBar Omnidirectional***

*< Default All GS1 DataBar Omnidirectional Settings >*



---

## ***GS1 DataBar Omnidirectional***



\* On



Off

---

---

## ***GS1 DataBar Limited***

*< Default All GS1 DataBar Limited Settings >*



## ***GS1 DataBar Limited***



\* On



Off

---

---

## ***GS1 DataBar Expanded***

*< Default All GS1 DataBar Expanded Settings >*



---

## GS1 DataBar Expanded



\* On



Off

### GS1 DataBar Expanded Message Length

Scan the barcodes below to change the message length. Refer to [Message Length](#) on page 6-2 for additional information. Minimum and Maximum lengths = 4-74. Minimum Default = 4, Maximum Default = 74.



Minimum Message Length



Maximum Message Length

---

---

## GS1 Emulation

The imager can automatically format the output from any GS1 data carrier to emulate what would be encoded in an equivalent GS1-128 or GS1 DataBar symbol. GS1 data carriers include UPC-A and UPC-E, EAN-13 and EAN-8, ITF-14, GS1-128, and GS1-128 DataBar and GS1Composites. If GS1-128 Emulation is selected, the AIM Symbology Identifier will be reported as “JC1”. If GS1 DataBar Emulation is selected, the AIM Symbology Identifier will be reported as “je0.” Any application that accepts GS1 data can be simplified since it only needs to recognize one data carrier type. *Default = GS1 Emulation Off.*



GS1 DataBar Emulation



128 Emulation



\* GS1 Emulation Off

---

---

---

## China Post Code

<Default All China Post Code Settings>



---

## China Post Code



On



\* Off

## China Post Message Length

Scan the barcodes below to change the message length. Refer to [Message Length](#) on page 6-2 for additional information. Minimum and Maximum lengths = 2-80. Minimum Default = 4, Maximum Default = 80.



Minimum Message Length



Maximum Message Length

---

---

---

## **Korea Post Code**

*<Default All Korea Post Code Settings>*



---

## **Korea Post Code**



On



\* Off

## **Korea Post Message Length**

Scan the barcodes below to change the message length. Refer to [Message Length](#) on page 6-2 for additional information. Minimum and Maximum lengths = 2-80. Minimum Default = 4, Maximum Default = 48.



Minimum Message Length



Maximum Message Length

---

---

## **PosiCode**

*<Default All PosiCode Settings>*



---

## **PosiCode A and B**



\* On



Off



---

You have to have PosiCode A and B on to read any of the PosiCode symbolologies.



A and B On  
(No Limited)



A and B and Limited A On  
(Limited B Off)



\* A and B and Limited B On  
(Limited A Off)

### **PosiCode Message Length**

Scan the barcodes below to change the message length. Refer to [Message Length](#) on page 6-2 for additional information. Minimum and Maximum lengths = 2-80. Minimum Default = 4, Maximum Default = 48.



Minimum Message Length



Maximum Message Length

---

## ***Trioptic Code***

Trioptic Code is used for labeling magnetic storage media.

*Note: If you are going to scan Code 32 Pharmaceutical codes, Trioptic Code must be off.*



On



\* Off

---

## **Codablock F**

*<Default All Codablock F Settings>*



---

## **Codablock F**



On



\* Off

### **Codablock F Message Length**

Scan the barcodes below to change the message length. Refer to [Message Length](#) on page 6-2 for additional information. Minimum and Maximum lengths = 1-2048. Minimum Default = 1, Maximum Default = 2048.



Minimum Message Length



Maximum Message Length

---

---

## **Code 16K**

*<Default All Code 16K Settings>*



---

## Code 16K



On



\* Off

### Code 16K Message Length

Scan the barcodes below to change the message length. Refer to [Message Length](#) on page 6-2 for additional information. Minimum and Maximum lengths = 0-160. Minimum Default = 1, Maximum Default = 160.



Minimum Message Length



Maximum Message Length

---

---

## Code 49

<Default All Code 49 Settings>



## Code 49



\* On



Off

---

---

### **Code 49 Message Length**

Scan the barcodes below to change the message length. Refer to [Message Length](#) on page 6-2 for additional information. Minimum and Maximum lengths = 1-81. Minimum Default = 1, Maximum Default = 81.



Minimum Message Length



Maximum Message Length

**Keyboard Function Relationships**

The following Keyboard Function Code, Hex/ASCII Value, and Full ASCII “CTRL”+ relationships apply to all terminals that can be used with the image scanner. Refer to page 2-7 enable Control + ASCII mode.

<b>Function Code</b>	<b>HEX/ASCII Value</b>	<b>Full ASCII “CTRL” +</b>
NUL	00	@
SOH	01	A
STX	02	B
ETX	03	C
EOT	04	D
ENQ	05	E
ACK	06	F
BEL	07	G
BS	08	H
HT	09	I
LF	0A	J
VT	0B	K
FF	0C	L
CR	0D	M
SO	0E	N
SI	0F	O
DLE	10	P
DC1	11	Q
DC2	12	R
DC3	13	S
DC4	14	T
NAK	15	U
SYN	16	V
ETB	17	W
CAN	18	X
EM	19	Y
SUB	1A	Z
ESC	1B	[
FS	1C	\
GS	1D	]
RS	1E	^
US	1F	_

The last five characters in the Full ASCII "CTRL" column ([ \ ] 6 - ), apply to US only. The following chart indicates the equivalents of these five characters for different countries.

Country	Codes				
United States	[	\	]	6	-
Belgium	[	<	]	6	-
Scandinavia	8	<	9	6	-
France	^	8	\$	6	=
Germany		Ã	+	6	-
Italy		\	+	6	-
Switzerland		<	..	6	-
United Kingdom	[	¢	]	6	-
Denmark	8	\	9	6	-
Norway	8	\	9	6	-
Spain	[	\	]	6	-

## Supported Interface Keys

ASCII	HEX	IBM AT/XT and PS/2 Compatibles, WYSE PC/AT Supported Keys	IBM XTs and Compatibles Supported Keys	IBM, DDC, Memorex Telex, Harris* Supported Keys
NUL	00	Reserved	Reserved	Reserved
SOH	01	Enter (KP)	CR/Enter	Enter
STX	02	Cap Lock	Caps Lock	F11
ETX	03	ALT make	Reserved	F12
EOT	04	ALT break	Reserved	F13
ENQ	05	CTRL make	Reserved	F14
ACK	06	CTRL break	Reserved	F15
BEL	07	CR/Enter	CR/Enter	New Line
BS	08	Reserved	Reserved	F16
HT	09	Tab	Tab	F17
LF	0A	Reserved	Reserved	F18
VT	0B	Tab	Tab	Tab/Field Forward
FF	0C	Delete	Delete	Delete
CR	0D	CR/Enter	CR/Enter	Field Exit/New Line
SO	0E	Insert	Insert	Insert
SI	0F	Escape	Escape	F19
DLE	10	F11	Reserved	Error Reset
DC1	11	Home	Home	Home
DC2	12	Print	Print	F20
DC3	13	Back Space	Back Space	Back Space
DC4	14	Back Tab	Back Tab	Backfield/Back Tab
NAK	15	F12	Reserved	F21
SYN	16	F1	F1	F1
ETB	17	F2	F2	F2
CAN	18	F3	F3	F3
EM	19	F4	F4	F4
SUB	1A	F5	F5	F5
ESC	1B	F6	F6	F6
FS	1C	F7	F7	F7
GS	1D	F8	F8	F8
RS	1E	F9	F9	F9
US	1F	F10	F10	F10

\* IBM 3191/92, 3471/72, 3196/97, 3476/77, Telex (all models)

## Supported Interface Keys

ASCII	HEX	IBM, Memorex Telex (102)* Supported Keys	Memorex Telex (88)** Supported Keys
NUL	00	Reserved	Reserved
SOH	01	Enter	Enter
STX	02	F11	PF10
ETX	03	F12	PF11
EOT	04	F13	PF12
ENQ	05	F14	Reserved
ACK	06	F15	Reserved
BEL	07	New Line	New Line
BS	08	F16	Field Forward
HT	09	F17	Field Forward
LF	0A	F18	Reserved
VT	0B	Tab/Field Forward	Field Forward
FF	0C	Delete	Delete
CR	0D	Field Exit	New Line
SO	0E	Insert	Insert
SI	0F	Clear	Erase
DLE	10	Error Reset	Error Reset
DC1	11	Home	Reserved
DC2	12	Print	Print
DC3	13	Back Space	Back Space
DC4	14	Back Tab	Back Field
NAK	15	F19	Reserved
SYN	16	F1	PF1
ETB	17	F2	PF2
CAN	18	F3	PF3
EM	19	F4	PF4
SUB	1A	F5	PF5
ESC	1B	F6	PF6
FS	1C	F7	PF7
GS	1D	F8	PF8
RS	1E	F9	PF9
US	1F	F10	Home

\* IBM 3196/97, 3476/77, 3191/92, 3471/72, Memorex Telex (all models) with 102 key keyboards

\*\* Memorex Telex with 88 key keyboards



---

## ***Supported Interface Keys***

<b>ASCII</b>	<b>HEX</b>	<b>Esprit 200, 400 ANSI Supported Keys</b>	<b>Esprit 200, 400 ASCII Supported Keys</b>	<b>Esprit 200, 400 PC Supported Keys</b>
NUL	00	Reserved	Reserved	Reserved
SOH	01	New Line	New Line	New Line
STX	02	N/A	N/A	N/A
ETX	03	N/A	N/A	N/A
EOT	04	N/A	N/A	N/A
ENQ	05	N/A	N/A	N/A
ACK	06	N/A	N/A	N/A
BEL	07	New Line	New Line	New Line
BS	08	N/A	N/A	N/A
HT	09	Tab	Tab	Tab
LF	0A	N/A	N/A	N/A
VT	0B	Tab	Tab	Tab
FF	0C	N/A	N/A	Delete
CR	0D	New Line	New Line	New Line
SO	0E	N/A	N/A	Insert
SI	0F	Escape	Escape	Escape
DLE	10	F11	F11	F11
DC1	11	Insert	Insert	Home
DC2	12	F13	F13	Print
DC3	13	Back Space	Back Space	Back Space
DC4	14	Back Tab	Back Tab	Back Tab
NAK	15	F12	F12	F12
SYN	16	F1	F1	F1
ETB	17	F2	F2	F2
CAN	18	F3	F3	F3
EM	19	F4	F4	F4
SUB	1A	F5	F5	F5
ESC	1B	F6	F6	F6
FS	1C	F7	F7	F7
GS	1D	F8	F8	F8
RS	1E	F9	F9	F9
US	1F	F10	F10	F10

---

## ***Supported Interface Keys***

<b>ASCII</b>	<b>HEX</b>	<b>Apple Mac/iMac Supported Keys</b>
NUL	00	Reserved
SOH	01	Enter/Numpad Enter
STX	02	CAPS
ETX	03	ALT make
EOT	04	ALT break
ENQ	05	CNTRL make
ACK	06	CNTRL break
BEL	07	RETURN
BS	08	APPLE make
HT	09	TAB
LF	0A	APPLE break
VT	0B	TAB
FF	0C	Del
CR	0D	RETURN
SO	0E	Ins Help
SI	0F	ESC
DLE	10	F11
DC1	11	Home
DC2	12	Prnt Scrn
DC3	13	BACKSPACE
DC4	14	LSHIFT TAB
NAK	15	F12
SYN	16	F1
ETB	17	F2
CAN	18	F3
EM	19	F4
SUB	1A	F5
ESC	1B	F6
FS	1C	F7
GS	1D	F8
RS	1E	F9
US	1F	F10
DEL	7F	BACKSPACE

## ***To Add a Test Code I.D. Prefix to All Symbologies***

This selection allows you to turn on transmission of a Code I.D. before the decoded symbology. (See the [Symbology Chart](#), page A-1) for the single character code that identifies each symbology.) This action first clears all current prefixes, then programs a Code I.D. prefix for all symbologies. This is a temporary setting that will be removed when the unit is reset. For instructions on how to reset your image scanner, refer to [Reset Image Scanner](#) (page 8-1).



Add Code I.D. Prefix to  
All Symbologies (Temporary)

## ***Reset Image Scanner***

Scanning this barcode causes the image scanner to re-link with the base.



Reset Imager

## ***Show Software Revision***

Scan the barcode below to output the current software revision, unit serial number, and other product information for both the image scanner and base.



Show Revision

## ***Show Data Format***

Scan the barcode below to show current data format settings.



Data Format Settings

---

## ***Image Scanner Report***

Scan the barcode below to generate a report for the connected image scanners. The report indicates the port, work group, image scanner name, and address. To assign a name to your image scanner, refer to "[Menu Command Syntax](#)" on page 10-1.



Image Scanner Report

## ***Image Scanner Address***

Scan the barcode below to determine the address of the image scanner you are using.



Image Scanner Address

## ***Base Address***

Scan the barcode below to determine the address of the base you are using.



Base Address

## ***Resetting the Standard Product Default Settings: Current Application Work Group***

If you aren't sure what programming options are in your image scanner, or you've changed some options and want the standard product default settings restored, scan the **Standard Product Default Settings: Current Application Group** barcode below.

The [Menu Commands](#) starting on [page 10-6](#) list the factory default settings for each of the commands (indicated by an asterisk (\*) on the programming pages).

*Note: Scanning this barcode also causes both the image scanner and the base to perform a reset and become unlinked. Refer to "[Image Scanner Modes](#)" on page 1-5 for additional information.*



Standard Product Default Settings:  
Current Application Group

---

## **Resetting the Standard Product Default Settings: All Application Work Groups**

The following barcode defaults all of the work groups to the factory settings.



Standard Product Default Settings:  
All Application Groups

The [Menu Commands](#) starting on page 10-6 list the standard product default settings for each of the commands (indicated by an asterisk (\*) on the programming pages).

## **Temporary Visual Xpress Configuration**

For quick download communication configuration, scan the **Visual Xpress** barcode to temporarily configure the imager for Visual Xpress settings. Refer to [Visual Xpress](#) on page 9-1 for additional information about Visual Xpress.

*Note: Connect the imager using RS-232 cables. Scan the barcode below and the unit will communicate in RS-232 mode, allowing it to work with Visual Xpress. The imager reverts to the original or reprogrammed interface when the power is cycled.*



Visual Xpress

*Note: If you download new software into a unit, the user-programmed parameters are retained. If you need to discard user-programmed settings, scan the Standard Product Default Settings barcode (see [Resetting the Standard Product Default Settings: Current Application Work Group](#) on page 8-2).*



## **Visual Xpress Introduction**

Visual Xpress provides a wide range of PC-based programming functions that can be performed on an imager connected to your PC's COM port. Visual Xpress allows you to download upgrades to the imager's firmware, change programmed parameters, and create and print programming barcodes. Using Visual Xpress, you can even save/open the programming parameters for an imager. This saved file can be e-mailed or, if required, you can create a single barcode that contains all the customized programming parameters and mail or fax that barcode to any location. Users in other locations can scan the barcode to load in the customized programming.

To communicate with an imager, Visual Xpress requires that the PC have at least one available serial communication port, or a serial port emulation using a physical USB port. If you are using the serial port and RS-232 cable, an external power supply is required. When using a USB serial port emulation, only a USB cable is required.

## **Visual Xpress Operations**

The Visual Xpress software performs the following operations:

### **Scan Data**

Scan Data allows you to scan barcodes and display the barcode data in a window. Scan Data lets you send serial commands to the imager and receive imager response that can be seen in the Scan Data window. The data displayed in the Scan Data window can either be saved in a file or printed.

### **Configure**

Configure displays the programming and configuration data of the imager. The imager's programming and configuration data is grouped into different categories. Each category is displayed as a tree item under the "Configure" tree node in the application explorer. When one of these tree nodes is clicked, the right-hand side is loaded with the parameters' form belonging to that particular category. The "Configure" tree option has all the programming and configuration parameters specified for an imager. You can set or modify these parameters as required. You can later write the modified settings to the imager, or save them to a dcf file.

### **Imaging**

Imaging provides all the image-related functions that a 2D Imager can perform. You can capture an image using the current settings, and the image will be displayed in an image window. Images captured from the imager can be saved to files in different image formats. You can modify the image settings and save the image settings to an INI file, which can be loaded later to capture new images. Imaging also lets you preview the images continuously captured by the imager.

---

## ***Installing Visual Xpress from the Web***

*Note: Visual Xpress requires .NET software. If .NET is not installed on your PC, you will be prompted to install it during the Visual Xpress installation.*

1. Access the Honeywell web site at [www.honeywell.com/aidc](http://www.honeywell.com/aidc)
2. Click on **Software Downloads**.
3. Select your product from the dropdown list.
4. Click on the entry for **Visual Xpress**.
5. When prompted, select **Save File**, and save the files to the **c:\windows\temp** directory.
6. Once you have finished downloading the file, exit the web site.
7. Using Explorer, go to the **c:\windows\temp** file and open the zip file you saved.
8. Double click on **Setup.exe** and follow the screen prompts to install the Visual Xpress program.
9. To start Visual Xpress, click on **Start -All Programs-Hand Held Products-Visual Xpress**.



The serial programming commands can be used in place of the programming barcodes. Both the serial commands and the programming barcodes will program the 2020. For complete descriptions and examples of each serial programming command, refer to the corresponding programming barcode in this manual.

The device must be set to an RS-232 interface (see [page 1-21](#)). The following commands can be sent via a PC com port using terminal emulation software.

## Conventions

The following conventions are used for menu and query command descriptions: *parameterA* label representing the actual value you should send as part of a command.

[*option*] An optional part of a command.

{Data} Alternatives in a command.

**bold** Names of menus, menu commands, buttons, dialog boxes, and windows that appear on the screen.

## Menu Command Syntax

Menu commands have the following syntax (spaces have been used for clarity only):

*Prefix* [:Name:] Tag SubTag {Data} [, SubTag {Data}] [; Tag SubTag {Data}] [...]  
Storage

Prefix Three ASCII characters: **SYN M CR** (ASCII 22,77,13).

:Name: To send information to the image scanner (with the base connected to host): :3820/3820i: The default factory setting for a 3820/3820i image scanner is 3820/3820i. This setting is changed by using the BT\_NAM command, which accepts alphanumeric values. If the name is not known, a wildcard (\*) can be used :\*:

*Note: Since the base stores all work group settings and transfers to them to the image scanner once they are linked, changes are typically done to the base and not to the image scanner.*

Tag A 3 character case-insensitive field that identifies the desired menu command group. For example, all RS-232 configuration settings are identified with a Tag of **232**.

SubTag A 3 character case-insensitive field that identifies the desired menu command within the tag group. For example, the SubTag for the RS-232 baud rate is **BAD**.

---

Data	The new value for a menu setting, identified by the Tag and Sub-Tag.
Storage	A single character that specifies the storage table to which the command is applied. An exclamation point (!) performs the command's operation on the device's volatile menu configuration table. A period (.) performs the command's operation on the device's non-volatile menu configuration table. Use the non-volatile table only for semi-permanent changes you want saved through a power cycle.

### **Query Commands**

Several special characters can be used to query the device about its settings.

- ^ What is the default value for the setting(s).
- ? What is the device's current value for the setting(s).
- \* What is the range of possible values for the setting(s). (The device's response uses a dash (-) to indicate a continuous range of values. A pipe (|) separates items in a list of non-continuous values.)

#### **:Name: Field Usage (Optional)**

This command returns the query information from the image scanner.

#### **Tag Field Usage**

When a query is used in place of a Tag field, the query applies to the *entire* set of commands available for the particular storage table indicated by the Storage field of the command. In this case, the SubTag and Data fields should not be used because they are ignored by the device.

#### **SubTag Field Usage**

When a query is used in place of a SubTag field, the query applies only to the subset of commands available that match the Tag field. In this case, the Data field should not be used because it is ignored by the device.

#### **Data Field Usage**

When a query is used in place of the Data field, the query applies only to the specific command identified by the Tag and SubTag fields.

### **Concatenation of Multiple Commands**

Multiple commands can be issued within one Prefix/Storage sequence. Only the Tag, SubTag, and Data fields must be repeated for each command in the sequence. If additional commands are to be applied to the same Tag, then the new command sequence is separated with a comma (,) and only the SubTag and Data fields of the additional command are issued. If the additional command requires a different Tag field, the command is separated from previous commands by a semicolon (;).

---

## **Responses**

The device responds to serial commands with one of three responses:

**ACK**Indicates a good command which has been processed.

**ENQ**Indicates an invalid Tag or SubTag command.

**NAK**Indicates the command was good, but the Data field entry was out of the allowable range for this Tag and SubTag combination, e.g., an entry for a minimum message length of 100 when the field will only accept 2 characters.

When responding, the device echoes back the command sequence with the status character inserted directly before each of the punctuation marks (the period, exclamation point, comma, or semicolon) in the command.

## **Examples of Query Commands**

In the following examples, a bracketed notation [ ] depicts a non-displayable response.

*Example #1: What is the range of possible values for Codabar Coding Enable?*

**Enter:**       **cbrena\*.**

**Response:**   **CBRENA0-1[ACK]**

This response indicates that Codabar Coding Enable (CBRENA) has a range of values from 0 to 1 (off and on).

*Example #2: What is the default value for Codabar Coding Enable?*

**Enter:**       **cbrena^.**

**Response:**   **CBRENA1[ACK]**

This response indicates that the default setting for Codabar Coding Enable (CBRENA) is 1, or on.

*Example #3: What is the device's current setting for Codabar Coding Enable?*

**Enter:**       **cbrena?.**

**Response:**   **CBRENA1[ACK]**

This response indicates that the device's Codabar Coding Enable (CBRENA) is set to 1, or on.

---

*Example #4: What are the device's settings for all Codabar selections?*

**Enter:**           cbr?.

**Response:**   **CBRENA1[ACK],**  
                  **SSX0[ACK],**  
                  **CK20[ACK],**  
                  **CCT1[ACK],**  
                  **MIN2[ACK],**  
                  **MAX60[ACK],**  
                  **DFT[ACK].**

This response indicates that the device's Codabar Coding Enable (CBRENA) is set to 1, or on; the Start/Stop Character (SSX) is set to 0, or Don't Transmit; the Check Character (CK2) is set to 0, or Not Required; concatenation (CCT) is set to 1, or Enabled; the Minimum Message Length (MIN) is set to 2 characters; the Maximum Message Length (MAX) is set to 60 characters; and the Default setting (DFT) has no value.

## ***Trigger Commands***

You can activate and deactivate the image scanner with serial trigger commands. First, the image scanner must be put in Manual/Serial Trigger Mode either by scanning the Manual/Serial Trigger Mode barcode ([page 3-3](#)), or by sending the Manual/Serial Menu Command ([page 10-12](#)). Once the image scanner is in serial trigger mode, the trigger is activated and deactivated by sending the following commands:

Activate:**SYN T CR**

Deactivate:**SYN U CR**

The image scanner scans until a barcode has been read, until the deactivate command is sent, or until the serial time-out has been reached (see [Read Time-Out \(Serial Trigger Mode\)](#) on page 3-4 for a description, and the serial command on [page 10-12](#)).

## ***Resetting the Standard Product Default Settings: Current Application Work Group***

If you aren't sure what programming options are in your image scanner, or you've changed some options and want the standard product default settings restored, scan the ***Standard Product Default Settings: Current Application Group*** barcode below.

---

The [Menu Commands](#) starting on [page 10-6](#) list the factory default settings for each of the commands (indicated by an asterisk (\*) on the programming pages).

*Note: Scanning this barcode also causes both the image scanner and the base to perform a reset and become unlinked. Refer to "Linking Image Scanner to Base" on page 1-5 for additional information.*



Standard Product Default Settings:  
Current Application Group

*Note: If your image scanner is in multiple image scanner mode and you scan either the current or all application group default barcode, you will hear up to 30 seconds of beeping while all image scanners are re-linked from the base and the settings are defaulted to \* settings. The default interface is keyboard wedge and the default image scanner mode is single link mode.*

## ***Resetting the Standard Product Default Settings: All Application Work Groups***

The following barcode defaults all of the work groups to the factory settings.



Standard Product Default Settings:  
All Application Groups

The [Menu Commands](#) starting on [page 10-6](#) list the standard product default settings for each of the commands (indicated by an asterisk (\*) on the programming pages).

# Menu Commands

<b>Selection</b>	<b>Setting</b> <i>* Indicates default</i>	<b>Serial Command</b> <i># Indicates a numeric entry</i>	<b>Page</b>
Base Charge Mode	*Automatic	BASCHG1	1-4
	Full Charge Rate	BASCHG2	1-4
	Low Charge Rate	BASCHG3	1-4
	Battery Charge Off	BASCHG4	1-4
Image Scanner Modes - Single	Unlink Image Scanner	BT_RMV	1-5
	*Locked Link Mode	BASCON0,DNG1	1-6
	Open Link Mode	BASCON1,DNG1	1-6
	Override Locked Image Scanner	BT_RPL1	1-6
Multiple Image Scanner Operation	Multiple Image Scanner Operation	BASCON2,DNG3	1-7
Image Scanner Name	Image Scanner Name	BT_NAM	1-8
Image Scanner Report	Image Scanner Report	RPTSCN	1-9
Application Work Group Selections	*Group 0	GRPSEL0	1-10
	Group 1	GRPSEL1	1-10
	Group 2	GRPSEL2	1-10
	Group 3	GRPSEL3	1-10
	Group 4	GRPSEL4	1-10
	Group 5	GRPSEL5	1-10
	Group 6	GRPSEL6	1-10
Standard Product Defaults: Current Application Work Group	Default - Current Work Group	DEFAULT	1-11
Standard Product Defaults: All Application Work Groups	Default - All Work Groups	PAPDFT	1-11
Non-Base Bluetooth Connection	Non-Base BT Connection	BT_DNG5	1-12
Bluetooth PIN Code	Bluetooth PIN	BT_PIN	1-12

<b>Selection</b>	<b>Setting</b> <i>* Indicates default</i>	<b>Serial Command</b> <i># Indicates a numeric entry</i>	<b>Page</b>
Out-of-Range Alarm	Base Alarm Duration (Range 1 - 3000 sec (*0))	BASORD	<a href="#">1-13</a>
	Image Scanner Alarm Duration (Range 1 - 3000 sec (*0))	BT_ORD	<a href="#">1-13</a>
Alarm Sound Type	Base Alarm Type	BASORW	<a href="#">1-13</a>
	Image Scanner Alarm Type	BT_ORW	<a href="#">1-13</a>
Data Accumulation Mode	On	BATENA1	<a href="#">1-13</a>
	*Off	BATENA0	<a href="#">1-13</a>
Batch Mode Transmit Delay	*Off	BATDLY0	<a href="#">1-14</a>
	Short (ms)	BATDLY250	<a href="#">1-14</a>
	Medium (ms)	BATDLY500	<a href="#">1-14</a>
	Long (ms)	BATDLY1000	<a href="#">1-14</a>
Factory Default Settings	Default	DEFAULT	<a href="#">1-20</a>
<b><i>Terminal Interfaces</i></b>			
Terminal ID	*003	TERMID###	<a href="#">2-2</a>

<b>Selection</b>	<b>Setting</b> <i>* Indicates default</i>	<b>Serial Command</b> <i># Indicates a numeric entry</i>	<b>Page</b>
Program Keyboard Country	*U.S.A.	KBDCTY0	2-4
	Belgium	KBDCTY1	2-4
	Brazil	KBDCTY16	2-4
	Canada (French)	KBDCTY18	2-4
	Czech Republic	KBDCTY15	2-4
	Denmark	KBDCTY8	2-4
	Finland (Sweden)	KBDCTY2	2-4
	France	KBDCTY3	2-4
	Germany/Austria	KBDCTY4	2-4
	Greece	KBDCTY17	2-4
	Hungary	KBDCTY19	2-4
	Israel (Hebrew)	KBDCTY12	2-4
	Italy	KBDCTY5	2-5
	Latin America	KBDCTY14	2-5
	Netherlands (Dutch)	KBDCTY11	2-5
	Norway	KBDCTY9	2-5
	Poland	KBDCTY20	2-5
	Portugal	KBDCTY13	2-5
	Romania	KBDCTY25	2-5
	Russia	KBDCTY26	2-5
	SCS	KBDCTY21	2-5
	Slovakia	KBDCTY22	2-5
	Spain	KBDCTY10	2-5
	Sweden	KBDCTY23	2-5
	Switzerland (German)	KBDCTY6	2-5
	Turkey F	KBDCTY27	2-5
Turkey Q	KBDCTY24	2-5	
U.K.	KBDCTY7	2-5	



<b>Selection</b>	<b>Setting</b> <i>* Indicates default</i>	<b>Serial Command</b> <i># Indicates a numeric entry</i>	<b>Page</b>
Keyboard Style	*Regular	KBDSTY0	<a href="#">2-6</a>
	Caps Lock	KBDSTY1	<a href="#">2-6</a>
	Shift Lock	KBDSTY2	<a href="#">2-6</a>
	Automatic Caps Lock	KBDSTY6	<a href="#">2-6</a>
	Emulate External Keyboard	KBDSTY5	<a href="#">2-7</a>
Keyboard Modifiers	*Control + ASCII Off	KBDCAS0	<a href="#">2-7</a>
	Control + ASCII On	KBDCAS2	<a href="#">2-7</a>
	*Turbo Mode Off	KBDTMD0	<a href="#">2-7</a>
	Turbo Mode On	KBDTMD1	<a href="#">2-7</a>
	*Numeric Keypad Off	KBDNPS0	<a href="#">2-7</a>
	Numeric Keypad On	KBDNPS1	<a href="#">2-7</a>
	*Auto Direct Conn. Off	KBDADC0	<a href="#">2-8</a>
	Auto Direct Conn. On	KBDADC1	<a href="#">2-8</a>
Serial Port Connection	RS-232	PAP232	<a href="#">2-9</a>
Baud Rate	300 BPS	232BAD0	<a href="#">2-9</a>
	600 BPS	232BAD1	<a href="#">2-9</a>
	1200 BPS	232BAD2	<a href="#">2-9</a>
	2400 BPS	232BAD3	<a href="#">2-9</a>
	4800 BPS	232BAD4	<a href="#">2-9</a>
	9600 BPS	232BAD5	<a href="#">2-9</a>
	19200 BPS	232BAD6	<a href="#">2-9</a>
	38400 BPS	232BAD7	<a href="#">2-9</a>
	57600 BPS	232BAD8	<a href="#">2-9</a>
	*115200 BPS	232BAD9	<a href="#">2-9</a>

<b>Selection</b>	<b>Setting</b> <i>* Indicates default</i>	<b>Serial Command</b> <i># Indicates a numeric entry</i>	<b>Page</b>
Word Length: Data Bits, Stop Bits, and Parity	7 Data, 1 Stop, Parity Even	232WRD3	<a href="#">2-10</a>
	7 Data, 1 Stop, Parity None	232WRD0	<a href="#">2-10</a>
	7 Data, 1 Stop, Parity Odd	232WRD6	<a href="#">2-10</a>
	7 Data, 2 Stop, Parity Even	232WRD4	<a href="#">2-10</a>
	7 Data, 2 Stop, Parity None	232WRD1	<a href="#">2-10</a>
	7 Data, 2 Stop, Parity Odd	232WRD7	<a href="#">2-10</a>
	8 Data, 1 Stop, Parity Even	232WRD5	<a href="#">2-10</a>
	*8 Data, 1 Stop, Parity None	232WRD2	<a href="#">2-10</a>
	8 Data, 1 Stop, Parity Odd	232WRD8	<a href="#">2-10</a>
RS-232 Handshaking	*RTS/CTS Off	232CTS0	<a href="#">2-11</a>
	RTS/CTS On	232CTS2	<a href="#">2-11</a>
	*XON/XOFF Off	232XON0	<a href="#">2-11</a>
	XON/XOFF On	232XON1	<a href="#">2-11</a>
	*ACK/NAK Off	232ACK0	<a href="#">2-11</a>
	ACK/NAK On	232ACK1	<a href="#">2-11</a>
Wand Emulation Connection	Same Code Format	TERMID64	<a href="#">2-14</a>
	Code 39 Format	TERMID61	<a href="#">2-14</a>
Wand Emulation Transmission Rate	10	WNDSPD0	<a href="#">2-15</a>
	*25	WNDSPD1	<a href="#">2-15</a>
	40	WNDSPD2	<a href="#">2-15</a>
	80	WNDSPD3	<a href="#">2-15</a>
	120	WNDSPD4	<a href="#">2-15</a>
	150	WNDSPD5	<a href="#">2-15</a>
	200	WNDSPD6	<a href="#">2-15</a>

<b>Selection</b>	<b>Setting</b> <i>* Indicates default</i>	<b>Serial Command</b> <i># Indicates a numeric entry</i>	<b>Page</b>
Wand Emulation Polarity	*Black High	WNDPOL0	<a href="#">2-15</a>
	White High	WNDPOL1	<a href="#">2-15</a>
Wand Emulation Idle	Idle Low	WNDIDL0	<a href="#">2-15</a>
	*Idle High	WNDIDL1	<a href="#">2-15</a>
Wand Emulation Data Block Size	20	WNDBLK0	<a href="#">2-16</a>
	*40	WNDBLK1	<a href="#">2-16</a>
	60	WNDBLK2	<a href="#">2-16</a>
	80	WNDBLK3	<a href="#">2-16</a>
Wand Emulation Delay Between Blocks	5ms	WNDDLY0	<a href="#">2-16</a>
	*50ms	WNDDLY1	<a href="#">2-16</a>
	150ms	WNDDLY2	<a href="#">2-16</a>
	500ms	WNDDLY3	<a href="#">2-16</a>
Wand Emulation Overall Checksum	*Off	WNDCHK0	<a href="#">2-16</a>
	On	WNDCHK1	<a href="#">2-16</a>
<b><i>Output Selections</i></b>			
Beeper - Good Read	Off	BEPBEP0	<a href="#">3-1</a>
	*On	BEPBEP1	<a href="#">3-1</a>
Beeper Volume - Good Read	Off	BEPLVL0	<a href="#">3-1</a>
	Low	BEPLVL1	<a href="#">3-1</a>
	*Medium	BEPLVL2	<a href="#">3-1</a>
	High	BEPLVL3	<a href="#">3-1</a>
Beeper Pitch - Good Read (Frequency)	Low (1600) (min 400Hz)	BEPFQ11600	<a href="#">3-2</a>
	*Medium (3250)	BEPFQ13250	<a href="#">3-2</a>
	High (4200) (max 9000Hz)	BEPFQ14200	<a href="#">3-2</a>
Beeper Duration - Good Read	*Normal Beep	BEPBIP0	<a href="#">3-2</a>
	Short Beep	BEPBIP1	<a href="#">3-2</a>
LED - Good Read	Off	BEPLED0	<a href="#">3-2</a>
	*On	BEPLED1	<a href="#">3-2</a>

<b>Selection</b>	<b>Setting</b> <i>* Indicates default</i>	<b>Serial Command</b> <i># Indicates a numeric entry</i>	<b>Page</b>
Number of Beeps - Good Read	*1	BEP RPT1	3-2
	Range 1 - 9	BEP RPT#	3-2
Good Read Delay	*No Delay	DLYGRD0	3-3
	Short Delay (500 ms)	DLYGRD500	3-3
	Medium Delay (1000 ms)	DLYGRD1000	3-3
	Long Delay (1500 ms)	DLYGRD1500	3-3
User-Specified Good Read Delay	Range 0 - 30,000 ms	DLYGRD#####	3-3
Trigger Mode	*Manual Trigger	TRGMOD0	3-3
	Read Time-Out (0 - 300,000 ms) *30,000	TRGSTO####	3-4
	Image Scanner Power Time-Out Timer (0-7200 seconds) *3600	BT_LPT0	3-5
		BT_LPT200	3-5
		BT_LPT400	3-5
		BT_LPT900	3-5
		BT_LPT3600	3-5
		BT_LPT7200	3-5
	Automatic Trigger	TRGMOD1	3-5
	Presentation Mode	TRGMOD3	3-5
Hands Free Time-Out (0-300,000 seconds) *5000	TRGP TO#####	3-6	
Reread Delay	Short (500 ms)	DLYRRD500	3-6
	*Medium (750 ms)	DLYRRD750	3-6
	Long (1000 ms)	DLYRRD1000	3-6
	Extra Long (2000 ms)	DLYRRD3000	3-6
User-Specified Reread Delay	Range 0 - 30,000 ms	DLYRRD#####	3-6

<b>Selection</b>	<b>Setting</b> <i>* Indicates default</i>	<b>Serial Command</b> <i># Indicates a numeric entry</i>	<b>Page</b>
Centering	Centering On	DECWIN1	3-7
	*Centering Off	DECWIN0	3-7
	Left of Centering Window *40	DECLFT###	3-7
	Right of Centering Window *60	DECRGT###	3-7
Preferred Symbology	On	PRFENA1	3-8
	*Off	PRFENA0	3-8
	High Priority Symbology	PRFCOD##	3-9
	Low Priority Symbology	PRFBLK##	3-9
	Preferred Symbology Timeout (*500) Range 100-3000	PRFP TO####	3-9
	Preferred Symbology Default	PRFDFT	3-9
Output Sequence Editor	Enter Sequence	SEQBLK	3-11
	Default Sequence	SEQDFT	3-11
Require Output Sequence	Required	SEQ_EN2	3-11
	On/Not Required	SEQ_EN1	3-11
	*Off	SEQ_EN0	3-11
Multiple Symbols	On	SHOTGN1	3-14
	*Off	SHOTGN0	3-14
No Read	On	SHWNRD1	3-14
	*Off	SHWNRD0	3-14
Video Reverse	On	VIDREV1	3-13
	*Off	VIDREV0	3-13
<b><i>Prefix/Suffix Selections</i></b>			
Add CR Suffix to All Symbologies		VSUF CR	4-3
Prefix	Add Prefix	PREBK2##	4-3
	Clear One Prefix	PRECL2	4-3
	Clear All Prefixes	PRECA2	4-3

<b>Selection</b>	<b>Setting</b> <i>* Indicates default</i>	<b>Serial Command</b> <i># Indicates a numeric entry</i>	<b>Page</b>
Suffix	Add Suffix	SUFBK2##	4-4
	Clear One Suffix	SUFCL2	4-4
	Clear All Suffixes	SUFCA2	4-4
Function Code Transmit	*Enable	RMVFNC0	4-4
	Disable	RMVFNC1	4-4
Intercharacter Delay		DLYCHR##	4-5
User Specified Inter-character Delay	Delay Length	DLYCRX##	4-5
	Character to Trigger Delay	DLY_XX###	4-5
Interfunction Delay		DLYFNC##	4-6
Intermessage Delay		DLYMSG##	4-6
<b>Data Formatter Selections</b>			
Data Format Editor	*Default Data Format (None)	DFMDF3	5-4
	Enter Data Format	DFMBK3##	5-4
	Clear One Data Format	DFMCL3	5-4
	Clear All Data Formats	DFMCA3	5-4
Data Formatter	Off	DFM_EN0	5-4
	*On, but Not Required	DFM_EN1	5-4
	On, Required	DFM_EN2	5-5
Alternate Data Formats	1	VSAF_1	5-5
	2	VSAF_2	5-5
	3	VSAF_3	5-5
<b>Symbologies</b>			
All Symbologies	All Symbologies Off	ALLENA0	6-1
	All Symbologies On	ALLENA1	6-1
Codabar	Default All Codabar Settings	CBRDFT	6-3
Codabar	Off	CBRENA0	6-3
	*On	CBRENA1	6-3

<b>Selection</b>	<b>Setting</b> <i>* Indicates default</i>	<b>Serial Command</b> <i># Indicates a numeric entry</i>	<b>Page</b>
Codabar Start/Stop Char.	*Don't Transmit	CBRSSX0	6-3
	Transmit	CBRSSX1	6-3
Codabar Check Char.	*No Check Char.	CBRCK20	6-4
	Validate, But Don't Transmit	CBRCK21	6-4
	Validate, and Transmit	CBRCK22	6-4
Codabar Concatenation	*Off	CBRCCT0	6-4
	On	CBRCCT1	6-4
	Require	CBRCCT2	6-4
Codabar Message Length	Minimum (2 - 60) *4	CBRMIN##	6-5
	Maximum (2 - 60) *60	CBRMAX##	6-5
Code 39	Default All Code 39 Settings	C39DFT	6-5
Code 39	Off	C39ENA0	6-5
	*On	C39ENA1	6-5
Code 39 Start/Stop Char.	*Don't Transmit	C39SSX0	6-5
	Transmit	C39SSX1	6-5
Code 39 Check Char.	*No Check Char.	C39CK20	6-6
	Validate, But Don't Transmit	C39CK21	6-6
	Validate, and Transmit	C39CK22	6-6
Code 39 Message Length	Minimum (0 - 48) *0	C39MIN##	6-6
	Maximum (0 - 48) *48	C39MAX##	6-6
Code 39 Append	*Off	C39APP0	6-7
	On	C39APP1	6-7
Code 32 Pharmaceutical (PARAF)	*Off	C39B320	6-7
	On	C39B321	6-7
Code 39 Full ASCII	*Off	C39ASC0	6-8
	On	C39ASC1	6-8
Interleaved 2 of 5	Default All Interleaved 2 of 5 Settings	I25DFT	6-9

<b>Selection</b>	<b>Setting</b> <i>* Indicates default</i>	<b>Serial Command</b> <i># Indicates a numeric entry</i>	<b>Page</b>
Interleaved 2 of 5	Off	I25ENA0	6-9
	*On	I25ENA1	6-9
Interleaved 2 of 5 Check Digit	*No Check Char.	I25CK20	6-10
	Validate, But Don't Transmit	I25CK21	6-10
	Validate, and Transmit	I25CK22	6-10
Interleaved 2 of 5 Message Length	Minimum (2 - 80) *4	I25MIN##	6-10
	Maximum (2 - 80) *80	I25MAX##	6-10
Code 93	Default All Code 93 Settings	C93DFT	6-11
Code 93	Off	C93ENA0	6-11
	*On	C93ENA1	6-11
Code 93 Message Length	Minimum (0 - 80) *0	C93MIN##	6-11
	Maximum (0 - 80) *80	C93MAX##	6-11
Straight 2 of 5 Industrial	Default All Straight 2 of 5 Industrial Settings	R25DFT	6-12
Straight 2 of 5 Industrial	*Off	R25ENA0	6-12
	On	R25ENA1	6-12
Straight 2 of 5 Industrial Message Length	Minimum (1 - 48) *4	R25MIN##	6-12
	Maximum (1 - 48) *48	R25MAX##	6-12
Straight 2 of 5 IATA	Default All Straight 2 of 5 IATA Settings	A25DFT	6-13
Straight 2 of 5 IATA	*Off	A25ENA0	6-13
	On	A25ENA1	6-13
Straight 2 of 5 IATA Message Length	Minimum (1 - 48) *4	A25MIN##	6-13
	Maximum (1 - 48) *48	A25MAX##	6-13
Matrix 2 of 5	Default All Matrix 2 of 5 Settings	X25DFT	6-13
Matrix 2 of 5	*Off	X25ENA0	6-13
	On	X25ENA1	6-13



<b>Selection</b>	<b>Setting</b> <i>* Indicates default</i>	<b>Serial Command</b> <i># Indicates a numeric entry</i>	<b>Page</b>
Matrix 2 of 5 Message Length	Minimum (1 - 80) *4	X25MIN##	6-14
	Maximum (1 - 80) *80	X25MAX##	6-14
Code 11	Default All Code 11 Settings	C11DFT	6-14
Code 11	*Off	C11ENA0	6-14
	On	C11ENA1	6-14
Code 11 Check Digits Required	1 Check Digit	C11CK20	6-14
	*2 Check Digits	C11CK21	6-14
Code 11 Message Length	Minimum (1 - 80) *4	C11MIN##	6-15
	Maximum (1 - 80) *80	C11MAX##	6-15
Code 128	Default All Code 128 Settings	128DFT	6-15
Code 128	Off	128ENA0	6-16
	*On	128ENA1	6-15
ISBT Concatenation	On	ISBENA1	6-16
	*Off	ISBENA0	6-16
Code 128 Message Length	Minimum (0 - 80) *0	128MIN##	6-16
	Maximum (0 - 80) *80	128MAX##	6-16
Code 128 Code Page	Code 128 Code Page	128DCP	6-16
Code 128 Function Code Transmit	*Off	128FNX0	6-17
	On	128FNX1	6-17
ISBT Concatenation	*Off	ISBENA0	6-16
	On	ISBENA1	6-16
Telepen	Default All Telepen Settings	TELDFT	6-17
Telepen	*Off	TELENA0	6-17
	On	TELENA1	6-17
Telepen Output	*AIM Telepen Output	TELOLD0	6-17
	Original Telepen Output	TELOLD1	6-17
Telepen Message Length	Minimum (1 - 60) *1	TELMIN##	6-18
	Maximum (1 - 60) *60	TELMAX##	6-18

<b>Selection</b>	<b>Setting</b> <i>* Indicates default</i>	<b>Serial Command</b> <i># Indicates a numeric entry</i>	<b>Page</b>
UPC A	Default All UPC A Settings	UPADFT	<a href="#">6-18</a>
UPC A	Off	UPAENA0	<a href="#">6-18</a>
	*On	UPAENA1	<a href="#">6-18</a>
UPC A Check Digit	Off	UPACKX0	<a href="#">6-18</a>
	*On	UPACKX1	<a href="#">6-18</a>
UPC A Number System	Off	UPANSX0	<a href="#">6-19</a>
	*On	UPANSX1	<a href="#">6-19</a>
UPC A 2 Digit Addenda	*Off	UPAAD20	<a href="#">6-19</a>
	On	UPAAD21	<a href="#">6-19</a>
UPC A 5 Digit Addenda	*Off	UPAAD50	<a href="#">6-19</a>
	On	UPAAD51	<a href="#">6-19</a>
UPC A Addenda Required	*Not Required	UPAARQ0	<a href="#">6-19</a>
	Required	UPAARQ1	<a href="#">6-19</a>
UPC A Addenda Separator	Off	UPAADS0	<a href="#">6-20</a>
	*On	UPAADS1	<a href="#">6-20</a>
UPC E	Default All UPC E Settings	UPEDFT	<a href="#">6-21</a>
UPC E0	Off	UPEEN00	<a href="#">6-21</a>
	*On	UPEEN01	<a href="#">6-21</a>
UPC E1	*Off	UPEEN10	<a href="#">6-21</a>
	On	UPEEN11	<a href="#">6-21</a>
UPC E Expand	*Off	UPEEXP0	<a href="#">6-21</a>
	On	UPEEXP1	<a href="#">6-21</a>
UPC E Check Digit	Off	UPECKX0	<a href="#">6-22</a>
	*On	UPECKX1	<a href="#">6-22</a>
UPC E Number System	Off	UPENSX0	<a href="#">6-22</a>
	*On	UPENSX1	<a href="#">6-22</a>
UPC E 2 Digit Addenda	*Off	UPEAD20	<a href="#">6-23</a>
	On	UPEAD21	<a href="#">6-23</a>

<b>Selection</b>	<b>Setting</b> <i>* Indicates default</i>	<b>Serial Command</b> <i># Indicates a numeric entry</i>	<b>Page</b>
UPC E 5 Digit Addenda	*Off	UPEAD50	6-23
	On	UPEAD51	6-23
UPC E Addenda Required	*Not Required	UPEARQ0	6-21
	Required	UPEARQ1	6-21
UPC E Addenda Separator	Off	UPEADS0	6-22
	*On	UPEADS1	6-22
EAN/JAN 13	Default All EAN/ JAN 13 Settings	E13DFT	6-23
EAN/JAN 13	Off	E13ENA0	6-23
	*On	E13ENA1	6-23
EAN/JAN 13 Check Digit	Off	E13CKX0	6-23
	*On	E13CKX1	6-23
EAN/JAN 13 2 Digit Addenda	*Off	E13AD20	6-24
	On	E13AD21	6-24
EAN/JAN 13 5 Digit Addenda	*Off	E13AD50	6-24
	On	E13AD51	6-24
EAN/JAN 13 Addenda Required	*Not Required	E13ARQ0	6-24
	Required	E13ARQ1	6-24
EAN/JAN 13 Addenda Separator	Off	E13ADS0	6-24
	*On	E13ADS1	6-24
ISBN Translate	*Off	E13ISB0	6-25
	On	E13ISB1	6-25
EAN/JAN 8	Default All EAN/ JAN 8 Settings	EA8DFT	6-25
EAN/JAN 8	Off	EA8ENA0	6-25
	*On	EA8ENA1	6-25
EAN/JAN 8 Check Digit	Off	EA8CKX0	6-25
	*On	EA8CKX1	6-25
EAN/JAN 8 2 Digit Addenda	*Off	EA8AD20	6-26
	On	EA8AD21	6-26

<b>Selection</b>	<b>Setting</b> <i>* Indicates default</i>	<b>Serial Command</b> <i># Indicates a numeric entry</i>	<b>Page</b>
EAN/JAN 8 5 Digit Addenda	*Off	EA8AD50	<a href="#">6-26</a>
	On	EA8AD51	<a href="#">6-26</a>
EAN/JAN 8 Addenda Required	*Not Required	EA8ARQ0	<a href="#">6-26</a>
	Required	EA8ARQ1	<a href="#">6-26</a>
EAN/JAN 8 Addenda Separator	Off	EA8ADS0	<a href="#">6-26</a>
	*On	EA8ADS1	<a href="#">6-26</a>
Coupon Code	Off	CPNENA0	<a href="#">6-26</a>
	*On	CPNENA1	<a href="#">6-20</a>
MSI	Default All MSI Settings	MSIDFT	<a href="#">6-27</a>
MSI	*Off	MSIENA0	<a href="#">6-27</a>
	On	MSIENA1	<a href="#">6-27</a>
MSI Check Character	*Validate Type 10, but Don't Transmit	MSICHK0	<a href="#">6-27</a>
	Validate Type 10 and Transmit	MSICHK1	<a href="#">6-27</a>
MSI Message Length	Minimum (4 - 48) *4	MSIMIN##	<a href="#">6-27</a>
	Maximum (4 - 48) *48	MSIMAX##	<a href="#">6-27</a>
Plessey Code	Default All Plessey Settings	PLSDFT	<a href="#">6-28</a>
Plessey Code	*Off	PLSENA0	<a href="#">6-28</a>
	On	PLSENA1	<a href="#">6-28</a>
Plessey Message Length	Minimum (4 - 48) *4	PLSMIN##	<a href="#">6-28</a>
	Maximum (4 - 48) *48	PLSMAX##	<a href="#">6-28</a>
GS1 DataBar	Default All GS1 DataBar Settings	RSSDFT	<a href="#">6-29</a>
GS1 DataBar	Off	RSEENA0	<a href="#">6-29</a>
	*On	RSEENA1	<a href="#">6-29</a>
GS1 DataBar Limited	Default All GS1 DataBar Limited Settings	RSLDFT	<a href="#">6-29</a>
GS1 DataBar Limited	Off	RSEENA0	<a href="#">6-29</a>
	*On	RSEENA1	<a href="#">6-29</a>

<b>Selection</b>	<b>Setting</b> <i>* Indicates default</i>	<b>Serial Command</b> <i># Indicates a numeric entry</i>	<b>Page</b>
GS1 DataBar Expanded	Default All GS1 DataBar Expanded Settings	RSEDFT	6-30
GS1 DataBar Expanded	Off	RSEENA0	6-30
	*On	RSEENA1	6-30
GS1 DataBar Expanded Msg. Length	Minimum (4 - 74) *4	RSEMIN##	6-30
	Maximum (4 - 74) *74	RSEMAX##	6-30
EAN•UCC Emulation	GS1 DataBar Emulation	EANEMU2	6-30
	128 Emulation	EANEMU1	6-30
	*EAN•UCC Emulation Off	EANEMU0	6-30
China Post Code	Default All China Post Code Settings	CPCDFT	6-31
China Post Code	*Off	CPCENA0	6-31
	On	CPCENA1	6-31
China Post Code Msg. Length	Minimum (2 - 80) *4	CPCMIN##	6-31
	Maximum (2 - 80) *80	CPCMAX##	6-31
Korea Post Code	Default All Korea Post Code Settings	KPCDFT	6-32
Korea Post Code	*Off	KPCENA0	6-32
	On	KPCENA1	6-32
Korea Post Code Msg. Length	Minimum (2 - 80) *4	KPCMIN##	6-32
	Maximum (2 - 80) *48	KPCMAX##	6-32
PosiCode	Default All PosiCode Settings	POSDFT	6-32

<b>Selection</b>	<b>Setting</b> <i>* Indicates default</i>	<b>Serial Command</b> <i># Indicates a numeric entry</i>	<b>Page</b>
PosiCode	Off	POSENA0	6-32
	*On	POSENA1	6-32
	A and B On	POSLIM0	6-33
	A and B and Limited A On	POSLIM1	6-33
	*A and B and Limited B On	POSLIM2	6-33
PosiCode Msg. Length	Minimum (2 - 80) *4	POSMIN##	6-33
	Maximum (2 - 80) *48	POSMAX##	6-33
Triopti Code	*Off	TRIENA0	6-33
	On	TRIENA1	6-33
Codablock F	Default All Codablock F Settings	CBFDFT	6-34
Codablock F	*Off	CBFENA0	6-34
	On	CBFENA1	6-34
Codablock F Msg. Length	Minimum (1 - 2048) *1	CBFMIN####	6-34
	Maximum (1 - 2048) *2048	CBFMAX####	6-34
Code 16K	Default All Code 16K Settings	16KDFT	6-34
Code 16K	*Off	16KENA0	6-35
	On	16KENA1	6-35
Code 16K	Minimum (0 - 160) *1	16KMIN###	6-35
	Maximum (0 - 160) *160	16KMAX###	6-35
Code 49	Default All Code 49 Settings	C49DFT	6-35
Code 49	Off	C49ENA0	6-35
	*On	C49ENA1	6-35
Code 49	Minimum (1 - 81) *1	C49MIN##	6-36
	Maximum (1 - 81) *81	C49MAX##	6-36
<b>Minimizing Bluetooth/ISM Band Network Activity</b>			

---

<b>Selection</b>	<b>Setting</b> <i>* Indicates default</i>	<b>Serial Command</b> <i># Indicates a numeric entry</i>	<b>Page</b>
Auto Reconnect Mode	*On	BT_ACM1	<a href="#">B-1</a>
	Off	BT_ACM0	<a href="#">B-1</a>
Maximum Link Attempts	*0 (0 - 100)	BT_MLA###	<a href="#">B-2</a>
Relink Time-Out	*3 (1 - 100)	BT_RLT###	<a href="#">B-3</a>





# Product Specifications

## 3820 Product Specifications

<b>Parameter</b>	<b>Specification</b>
Dimensions (Typical):	
Height	6.2 inches (15.7 cm)
Length	5.3 inches (13.5 cm)
Width	3.2 inches (8.1 cm)
Weight (with battery)	9.2 ounces (260 g)
Light Source	630 nM visible red LED
Scan Rate	270 scans per second in most usages
Skew Angle	±65 degrees
Pitch Angle	±65 degrees
Horizontal Velocity	2 inches (5 cm) per second
Scan Contrast	20% minimum
Battery:	
Lithium Ion	3.7 Volt 2000 mAHr
Battery Capacity:	<u>Standby</u> <u>Heavy Usage</u> (1 scan per second) 20 hours      12 hours
Storage:	5% loss per month
Radio:	
Frequency	2.4 to 2.4835 GHz (ISM Baqnd) Frequency Hopping Bluetooth v.2.0 + EDR
Range	33 ft. (10m) typical
Data Rate	720 KBps - 3MBps
Temperature Ranges:	
Operating	32° F to +122° F (0° C to +50° C)
Battery Charge	41° F to +104° F (5° C to +40° C)
Storage	-40° F to +140° F (-40° C to +60° C)
Humidity	Up to 95% non-condensing
Mechanical Drop	Operational after 50 drops from 6 feet (1.8 m) to concrete
Vibration	Withstands 5G peak from 22 to 300 Hz
ESD Sensitivity	15 kV to any external surface
Sealant Rating	IP41

# 3820i Product Specifications

<b>Parameter</b>	<b>Specification</b>
Dimensions (Typical):	
Height	6.5 inches (16.5 cm)
Length	5.3 inches (13.5 cm)
Width	3.2 inches (8.1 cm)
Weight (with battery)	9.6 ounces (272 g)
Light Source	630 nM visible red LED
Scan Rate	270 scans per second in most usages
Skew Angle	±65 degrees
Pitch Angle	±65 degrees
Horizontal Velocity	2 inches (5 cm) per second
Scan Contrast	20% minimum
Battery:	
Lithium Ion	3.7 Volt 2000 mAHr
Battery Capacity:	<u>Standby</u> <u>Heavy Usage</u> (1 scan per second) 20 hours      12 hours
Storage:	5% loss per month
Radio:	
Frequency	2.4 to 2.4835 GHz (ISM Baqnd) Frequency Hopping Bluetooth v.2.0 + EDR
Range	33 ft. (10m) typical
Data Rate	720 Kbps - 3MBps
Temperature Ranges:	
Operating	14° F to +122° F (-10° C to +50° C)
Battery Charge	41° F to +104° F (5° C to +40° C)
Storage	-40° F to +158° F (-40° C to +70° C)
Humidity	Up to 95% non-condensing
Mechanical Drop	Operational after 50 drops from 6.5 feet (1.9 m) to concrete
Vibration	Withstands 5G peak from 22 to 300 Hz
ESD Sensitivity	15 kV to any external surface
Sealant Rating	IP54





---

## *Standard Cable Pinouts*

### *Keyboard Wedge*

**10 Pin RJ41 Modular Plug**  
*connects to the base*

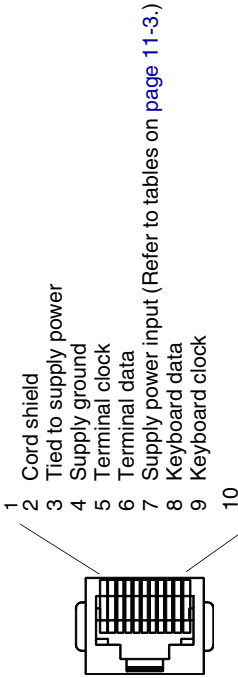

# Standard Cable Pinouts

## Wand Emulation

**10 Pin Modular Plug**  
*connects to the base*

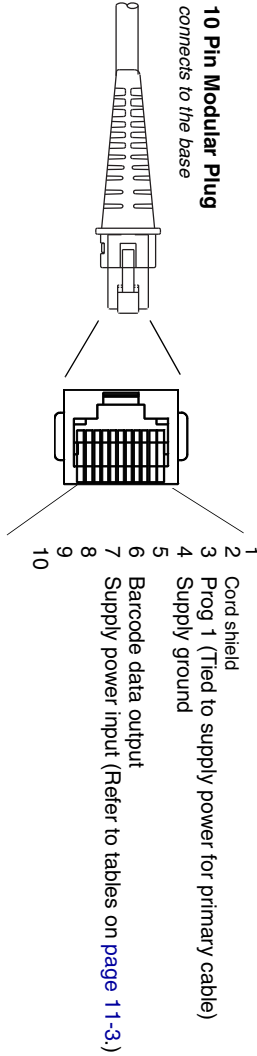

**9 Pin Type D Female**  
*connects to your terminal*

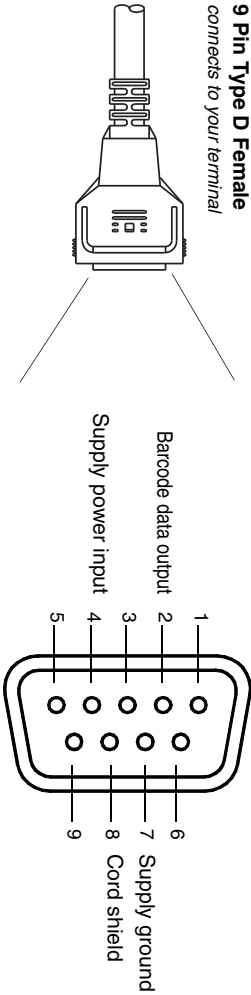

---

## Standard Cable Pinouts

### Serial Output

**10 Pin RJ41 Modular Plug**  
*connects to the base*

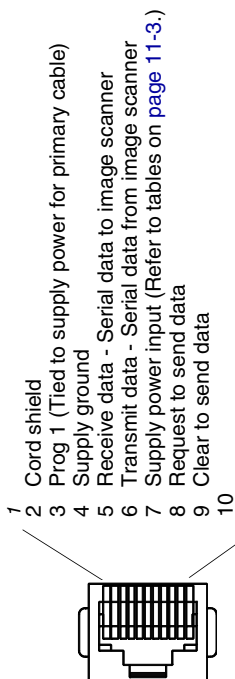

---

*Standard Cable Pinouts*  
**USB**

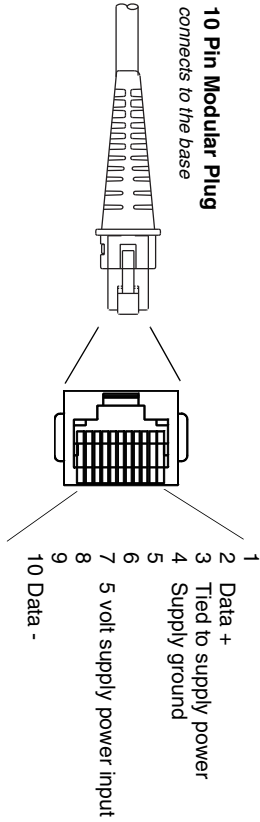



## Maintenance

Repairs and/or upgrades are not to be performed on this product. These services are to be performed only by an authorized service center. See ["Customer Support"](#) on page 13-1 for further information.

### *Cleaning the Device*

Reading performance may degrade if the image scanner's window is not clean. If the window is visibly dirty, or if the image scanner isn't operating well, clean the window with a soft cloth or lens tissue dampened with water (or a mild soapy water solution). If a detergent solution is used, rinse with a clean lens tissue dampened with water only.

The base and image scanner's housing may also be cleaned the same way.



### **Caution:**

**Do not submerge the image scanner in water. The image scanner's housing is not watertight.**

**Do not use abrasive wipes or tissues on the image scanner's window – abrasive wipes may scratch the window. Never use solvents (e.g., alcohol or acetone) on the housing or window – solvents may damage the finish or the window.**

### *Inspecting Cords and Connectors*

Inspect the base's interface cable and connector for wear or other signs of damage. A badly worn cable or damaged connector may interfere with image scanner operation. Contact your Honeywell distributor for information about cable replacement. Cable replacement instructions are on [page 12-2](#).

---

### **Replacing the 2020 Interface Cable:**

1. Turn the power to the host system OFF.
2. Disconnect the base's cable from the terminal or computer.
3. Turn the base upside down.
4. Pull the connector out while maintaining pressure on the connector release clip.
5. Replace with the new cable. Insert the connector into the opening and press firmly. The connector is keyed to go in only one way, and will click into place.

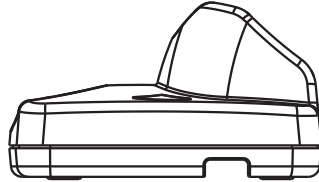

### **Changing the 3820/3820i**

#### **Battery:**

1. Remove the screw on the end cap on the 3820. On the 3820i, unscrew the thumb-wheel end cap.
2. Remove the battery from the handle.
3. Insert battery.
4. Replace end cap and screw or tighten the thumbwheel end cap.

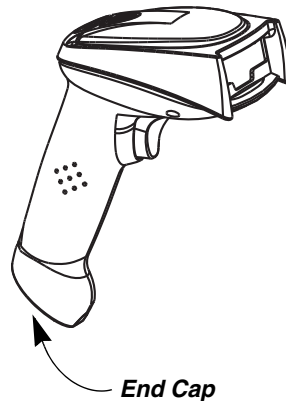

### **Troubleshooting**

#### **Base**

*Note: Please visit the Services and Support section of our website ([www.honeywell.com/aicd](http://www.honeywell.com/aicd)) to check for the latest software for both the image scanner and the base.*

If your base is not functioning properly, review the following troubleshooting guidelines to try to isolate the problem.

*Is the red LED on?*

If the red LED isn't illuminated, check that:

- 
- The power cable is connected properly and there is power at the power source.
  - The host system power is on (if external power isn't used).

*Is the green LED on?*

If the *green* LED isn't illuminated, check that:

- The image scanner is correctly placed in the base.
- There is external power or 12 volt host power.
- Charge mode is turned on. (See "[Base Charge Mode](#)" on page 1-4)
- The battery is not bad or deeply discharged. In some cases, the image scanner's battery may trickle charge to bring it into an acceptable level and then transition to a normal charge cycle.

Troubleshooting the Image Scanner

*Note: Make sure that your image scanner's battery is charged.*

*Note: Please visit the [Services and Support](#) section of our website ([www.honeywell.com/aidc](http://www.honeywell.com/aidc)) to check for the latest software for both the image scanner and the base.*

*Is the image scanner having trouble reading your symbols?*

If the image scanner isn't reading symbols well, check that the symbols:

- Aren't smeared, rough, scratched, or exhibiting voids.
- Aren't coated with frost or water droplets on the surface.
- Are enabled in the base to which the image scanner connects.

*Is the barcode displayed but not entered into the application?*

The barcode is displayed on the host device correctly, but you still have to press a key to enter it (the Enter/Return key or the Tab key, for example).

You need to program a suffix. Programming a suffix enables the image scanner to output the barcode data plus the key you need (such as "CR") to enter the data into your application. Refer to [Prefix/Suffix Overview](#) on page 4-1 for further information.

*Does the image scanner read the barcode incorrectly?*

If the image scanner reads a barcode, but the data is not displayed correctly on the host screen:

- The base may not be programmed for the appropriate terminal interface. For example, you scan "12345" and the host displays "@es%."

Reprogram the base with the correct Plug and Play or Terminal selection barcode. See [Chapter 1](#) and [Chapter 2](#).

- The base may not be programmed to output your barcode data properly. For example, you scan "12345" and the host displays "A12345B."

Reprogram the base with the proper symbology selections. See [Chapter 6](#).

---

*The image scanner won't read your barcode at all.*

1. Scan the sample barcodes in the back of this manual. If the image scanner reads the sample barcodes, check that your barcode is readable. Verify that your barcode symbology is enabled (see [Chapter 6](#)).
2. If the image scanner still can't read the sample barcodes, scan [All Symbologies](#) on page 6-1.

If you aren't sure what programming options have been set in the base, or if you want the factory default settings restored, scan [Resetting the Standard Product Default Settings: Current Application Work Group](#) on page 10-4.

#### Troubleshooting the Cordless System

The image scanner must be linked to the base for the system to work properly. See ["Linking Image Scanner to Base"](#) on page 1-5.

## Technical Assistance

If you need assistance installing or troubleshooting your device, please call your distributor or the nearest technical support office:

### North America/Canada

Telephone: (800) 782-4263  
Fax number: (315) 554-6705  
E-mail: [natechsupport@handheld.com](mailto:natechsupport@handheld.com)

### Latin America

Telephone: (803) 835-8000  
Telephone: (800) 782-4263  
E-mail: [latechsupport@handheld.com](mailto:latechsupport@handheld.com)

### Brazil

Telephone: +55 (21) 3535-9100  
Fax: +55 (21) 3535-9105  
E-mail: [brsuporte@handheld.com](mailto:brsuporte@handheld.com)

### Mexico

Telephone: (803) 835-8000  
E-mail: [latechsupport@handheld.com](mailto:latechsupport@handheld.com)

### Europe, Middle East, and Africa

Telephone: +31 (0) 40 7999 393  
Fax: +31 (0) 40 2425 672  
E-mail: [eurosupport@handheld.com](mailto:eurosupport@handheld.com)

### Asia Pacific

Telephone - Hong Kong: +852-3188-3485 or 2511-3050  
Telephone - China: +86 21 6361 3818  
E-mail: [aptechsupport@handheld.com](mailto:aptechsupport@handheld.com)

### Japan

Telephone: +813 5770-6312  
E-mail: [aptechsupport@handheld.com](mailto:aptechsupport@handheld.com)

### Malaysia

Telephone: +603-6201-7020  
E-mail: [aptechsupport@handheld.com](mailto:aptechsupport@handheld.com)

## Online Technical Assistance

You can also access technical assistance online at [www.honeywell.com/aidc](http://www.honeywell.com/aidc).

---

## ***Product Service and Repair***

Honeywell provides service for all its products through service centers throughout the world. To obtain warranty or non-warranty service, contact the appropriate location below to obtain a Return Material Authorization number (RMA #) before returning the product.

### **North America**

Telephone: (800) 782-4263  
Fax: (803) 835-8012  
*E-mail: naservice@handheld.com*

### **Latin America**

Telephone: (803) 835-8000  
Telephone: (800) 782-4263  
Fax: (239) 263-9689  
*E-mail: laservice@handheld.com*

### **Brazil**

Telephone: +55 (21) 3535-9100  
Fax: +55 (21) 3535-9105  
*E-mail: brservice@handheld.com*

### **Mexico**

Telephone: +52 (55) 5203-2100  
Fax: +52 (55) 5531-3672  
*E-mail: mxservice@handheld.com*

### **Europe, Middle East, and Africa**

Telephone: +31 (0) 40 2901 633  
Fax: +31 (0) 40 2901 631  
*E-mail: euservice@handheld.com*

### **Asia Pacific**

Telephone: +852-2511-3050  
Fax: +852-2511-3557  
*E-mail: apservice@handheld.com*

### **Japan**

Telephone: +813-5770-6312  
Fax: +813-5770-6313  
*E-mail: apservice@handheld.com*

## ***Online Product Service and Repair Assistance***

You can also access product service and repair assistance online at [www.honeywell.com/aidc](http://www.honeywell.com/aidc).

---

## ***Limited Warranty***

Honeywell International Inc. ("Honeywell") warrants its products to be free from defects in materials and workmanship and to conform to Honeywell's published specifications applicable to the products purchased at the time of shipment.

This warranty does not cover any Honeywell product which is (i) improperly installed or used; (ii) damaged by accident or negligence, including failure to follow the proper maintenance, service, and cleaning schedule; or (iii) damaged as a result of (A) modification or alteration by the purchaser or other party, (B) excessive voltage or current supplied to or drawn from the interface connections, (C) static electricity or electro-static discharge, (D) operation under conditions beyond the specified operating parameters, or (E) repair or service of the product by anyone other than Honeywell or its authorized representatives.

This warranty shall extend from the time of shipment for the duration published by Honeywell for the product at the time of purchase ("Warranty Period"). Any defective product must be returned (at purchaser's expense) during the Warranty Period to Honeywell's factory or authorized service center for inspection. No product will be accepted by Honeywell without a Return Materials Authorization, which may be obtained by contacting Honeywell. In the event that the product is returned to Honeywell or its authorized service center within the Warranty Period and Honeywell determines to its satisfaction that the product is defective due to defects in materials or workmanship, Honeywell, at its sole option, will either repair or replace the product without charge, except for return shipping to Honeywell.

EXCEPT AS MAY BE OTHERWISE PROVIDED BY APPLICABLE LAW, THE FOREGOING WARRANTY IS IN LIEU OF ALL OTHER COVENANTS OR WARRANTIES, EITHER EXPRESSED OR IMPLIED, ORAL OR WRITTEN, INCLUDING, WITHOUT LIMITATION, ANY IMPLIED WARRANTIES OF MERCHANTABILITY OR FITNESS FOR A PARTICULAR PURPOSE.

HONEYWELL'S RESPONSIBILITY AND PURCHASER'S EXCLUSIVE REMEDY UNDER THIS WARRANTY IS LIMITED TO THE REPAIR OR REPLACEMENT OF THE DEFECTIVE PRODUCT WITH NEW OR REFURBISHED PARTS. IN NO EVENT SHALL HONEYWELL BE LIABLE FOR INDIRECT, INCIDENTAL, OR CONSEQUENTIAL DAMAGES, AND, IN NO EVENT, SHALL ANY LIABILITY OF HONEYWELL ARISING IN CONNECTION WITH ANY PRODUCT SOLD HEREUNDER (WHETHER SUCH LIABILITY ARISES FROM A CLAIM BASED ON CONTRACT, WARRANTY, TORT, OR OTHERWISE) EXCEED THE ACTUAL AMOUNT PAID TO HONEYWELL FOR THE PRODUCT. THESE LIMITATIONS ON LIABILITY SHALL REMAIN IN FULL FORCE AND EFFECT EVEN WHEN HONEYWELL MAY HAVE BEEN ADVISED OF THE POSSIBILITY OF SUCH INJURIES, LOSSES, OR DAMAGES. SOME STATES, PROVINCES, OR COUNTRIES DO NOT ALLOW THE EXCLUSION OR LIMITATIONS OF INCIDENTAL OR CONSEQUENTIAL DAM-

---

AGES, SO THE ABOVE LIMITATION OR EXCLUSION MAY NOT APPLY TO YOU.

All provisions of this Limited Warranty are separate and severable, which means that if any provision is held invalid and unenforceable, such determination shall not affect the validity of enforceability of the other provisions hereof. Use of any peripherals not manufactured/sold by Honeywell may result in damage not covered by this warranty. This includes but is not limited to: cables, power supplies, cradles, and docking stations. Honeywell extends these warranties only to users of the products. These warranties are non-transferable. The duration of the limited warranty for the 2020 and 3820/3820i is three (3) years. The duration of the limited warranty for the image scanner battery is one (1) year.



## Symbology Chart

Symbology	Code ID	AIM ID	Hex ID	Symbology	Code ID	AIM ID	Hex ID
China Post	Q	]X0	51	Korea Post	?	]X0	3F
Codabar	a	]Fm	61	Matrix 2 of 5	m	]X0	6D
Codablock F	q	]Om	71	MSI	g	]Mm	67
Code 11	h	]Hm	68	No Read			9C
Code 16K	o	]Km	6F	Plessey Code	n	]P0	6E
Code 39	b	]Am	62	PosiCode	W	]pm	57
Code 32 Pharma- ceutical (PARAF)	<	]X0	3C	Reduced Space Symbology (GS1 DataBar, RSS Lim- ited, RSS Expanded)	y	]em	79
Code 49	l	]Tm	6C	Straight 2 of 5 IATA(2-bar start/ stop) Straight 2 of 5 Industrial (3-bar start/stop)	f	]Rm  ]S0	66
Code 93	i	]Gm	69	Telepen	t	]Bm	74
Code 128	j	]Cm	6A	Trioptic Code	=	]X0	3D
UCC/EAN-128	l	]C1	49	UPC-A	c	]E0	63
EAN/JAN-8	D	]E4	44	UPC-A with Extended Coupon Code	c	]E3	63
EAN/JAN-13	d	]E0	64	UPC-E	E	]E0	45
EAN-13 with Extended Coupon Code	d	]E3	64	<i>All Symbologies</i>			99
Interleaved 2 of 5	e	]lm	65				

Note: "m" represents the AIM modifier character. Refer to International Technical Specification, Symbology Identifiers, for AIM modifier character details.

Note: Prefix/Suffix entries for specific symbologies override the universal (All Symbologies, 99) entry.

Refer to [Data Editing](#) beginning on page 4-1 and [Data Formatting](#) beginning on page 5-1 for information about using Code ID and AIM ID.

# ASCII Conversion Chart (Code Page 1252)

Note: This table applies to U.S. style keyboards. Certain characters may differ depending on your Country Code/PC regional settings.

Dec	Hex	Char	Dec	Hex	Char	Dec	Hex	Char	Dec	Hex	Char
0	00	NUL	32	20		64	40	@	96	60	'
1	01	SOH	33	21	!	65	41	A	97	61	a
2	02	STX	34	22	"	66	42	B	98	62	b
3	03	ETX	35	23	#	67	43	C	99	63	c
4	04	EOT	36	24	\$	68	44	D	100	64	d
5	05	ENQ	37	25	%	69	45	E	101	65	e
6	06	ACK	38	26	&	70	46	F	102	66	f
7	07	BEL	39	27	'	71	47	G	103	67	g
8	08	BS	40	28	(	72	48	H	104	68	h
9	09	HT	41	29	)	73	49	I	105	69	i
10	0A	LF	42	2A	*	74	4A	J	106	6A	j
11	0B	VT	43	2B	+	75	4B	K	107	6B	k
12	0C	FF	44	2C	,	76	4C	L	108	6C	l
13	0D	CR	45	2D	-	77	4D	M	109	6D	m
14	0E	SO	46	2E	.	78	4E	N	110	6E	n
15	0F	SI	47	2F	/	79	4F	O	111	6F	o
16	10	DLE	48	30	0	80	50	P	112	70	p
17	11	DC1	49	31	1	81	51	Q	113	71	q
18	12	DC2	50	32	2	82	52	R	114	72	r
19	13	DC3	51	33	3	83	53	S	115	73	s
20	14	DC4	52	34	4	84	54	T	116	74	t
21	15	NAK	53	35	5	85	55	U	117	75	u
22	16	SYN	54	36	6	86	56	V	118	76	v
23	17	ETB	55	37	7	87	57	W	119	77	w
24	18	CAN	56	38	8	88	58	X	120	78	x
25	19	EM	57	39	9	89	59	Y	121	79	y
26	1A	SUB	58	3A	:	90	5A	Z	122	7A	z
27	1B	ESC	59	3B	;	91	5B	[	123	7B	{
28	1C	FS	60	3C	<	92	5C	\	124	7C	
29	1D	GS	61	3D	=	93	5D	]	125	7D	}
30	1E	RS	62	3E	>	94	5E	^	126	7E	~
31	1F	US	63	3F	?	95	5F	_	127	7F	

Dec.	Hex	Char	Dec.	Hex	Char	Dec.	Hex	Char	Dec.	Hex	Char
128	80	€	160	A0		192	C0	À	224	E0	à
129	81	□	161	A1	¡	193	C1	Á	225	E1	á
130	82	,	162	A2	¢	194	C2	Â	226	E2	â
131	83	f	163	A3	£	195	C3	Ã	227	E3	ã
132	84	„	164	A4	¤	196	C4	Ä	228	E4	ä
133	85	...	165	A5	¥	197	C5	Å	229	E5	å
134	86	†	166	A6	¦	198	C6	Æ	230	E6	æ
135	87	‡	167	A7	§	199	C7	Ç	231	E7	ç
136	88	^	168	A8	¨	200	C8	È	232	E8	è
137	89	‰	169	A9	©	201	C9	É	233	E9	é
138	8A	Š	170	AA	ª	202	CA	Ê	234	EA	ê
139	8B	‹	171	AB	«	203	CB	Ë	235	EB	ë
140	8C	Œ	172	AC	¬	204	CC	Ì	236	EC	ì
141	8D	□	173	AD	-	205	CD	Í	237	ED	í
142	8E	Ž	174	AE	®	206	CE	Î	238	EE	î
143	8F	□	175	AF	¯	207	CF	Ï	239	EF	ï
144	90	□	176	B0	°	208	D0	Ð	240	F0	ð
145	91	‘	177	B1	±	209	D1	Ñ	241	F1	ñ
146	92	’	178	B2	²	210	D2	Ò	242	F2	ò
147	93	“	179	B3	³	211	D3	Ó	243	F3	ó
148	94	”	180	B4	´	212	D4	Ô	244	F4	ô
149	95	•	181	B5	µ	213	D5	Õ	245	F5	õ
150	96	—	182	B6	¶	214	D6	Ö	246	F6	ö
151	97	—	183	B7	·	215	D7	×	247	F7	÷
152	98	˘	184	B8	¸	216	D8	Ø	248	F8	ø
153	99	™	185	B9	¹	217	D9	Ù	249	F9	ù
154	9A	š	186	BA	º	218	DA	Ú	250	FA	ú
155	9B	›	187	BB	»	219	DB	Û	251	FB	û
156	9C	œ	188	BC	¼	220	DC	Ü	252	FC	ü
157	9D	□	189	BD	½	221	DD	Ý	253	FD	ý
158	9E	ž	190	BE	¾	222	DE	Þ	254	FE	þ
159	9F	ÿ	191	BF	¿	223	DF	ß	255	FF	ÿ

---

## Code Page Mapping of Printed Barcodes

Code pages define the mapping of character codes to characters. If the data received does not display with the proper characters, it may be because the barcode being scanned was created using a code page that is different from the one the host program is expecting. If this is the case, select the code page with which the barcodes were created. The data characters should then appear properly.

*Note: The Code Page option is available for Code 39, Code 93, and Code 128.*

Code Page	Standard	Description
1	CP ISO646	
2 (Default)	ISO 2022	Automatic National Replacement Characters
3	CP Binary	
82	ISO 2022 11 Swe	Swedish Replacement Characters
83	ISO 2022 69 Fra	French/Belgium Replacement Characters
81	ISO 2022 25 Fra	French/Belgium Replacement Characters
84	ISO 2022 11 Ger	German Replacement Characters
85	ISO 2022 11 Ita	Italian Replacement Characters
86	ISO 2022 11 Swi	Swiss Replacement Characters
87	ISO 2022 11 UK	British Replacement Characters
88	ISO 2022 11 Dan	Danish Replacement Characters
89	ISO 2022 11 Nor	Norwegian Replacement Characters
90	ISO 2022 11 Spa	Spanish Replacement Characters

## Activity

The settings described below can help you customize the re-linking behavior of the cordless linear imaging system to obtain the best compromise between convenience and low interference.

*Note: ISM band refers to the 2.4 to 2.48 GHz frequency band used by wireless networks, cordless phones, and Bluetooth.*

### Auto Reconnect Mode

Auto Reconnect controls whether or not the image scanner automatically begins the re-link process when a loss of connection is detected. When the **Auto Reconnect On** barcode is scanned, the image scanner begins the re-link process immediately, without user intervention. *Default = Auto Reconnect On.*



\* Auto Reconnect On



Auto Reconnect Off

The table below shows the results of the Auto Reconnect On and Off settings:

Event	Auto Reconnect On	Auto Reconnect Off
Image scanner out of range	Re-link occurs automatically. If maximum number of link attempts (see <a href="#">Maximum Link Attempts</a> on page B-2) is unsuccessful, then the trigger must be pulled or the image scanner must be placed in the base unit to re-link.	The trigger must be pulled to initiate re-linking.
Base reset (firmware upgrade or power cycle)	Image scanner behaves as if out of range.	No attempt to re-link made while base unit is powered off. Trigger must be pulled to initiate re-linking.

Event	Auto Reconnect On	Auto Reconnect Off
Image scanner power down due to Power Time-Out Timer setting (see <a href="#">page 3-4</a> )	Trigger must be pulled or the image scanner must be placed in the base unit to re-link. (Note: image scanner re-links on power up, but powers on due to one of the above actions.)	
Image scanner reset due to firmware upgrade	Re-link occurs automatically.	
Image scanner reset due to battery change	Re-link occurs automatically.	
Image scanner placed in different base unit	Re-link to new base occurs automatically.	

**Maximum Link Attempts**

The Maximum Link Attempts setting controls the number of times the image scanner tries to form a connection with a base unit or PC. During the connection setup process, the image scanner transmits in order to search for and connect to a base unit. In order to prevent continuous transmissions that could interfere with other users of the ISM band, the number of attempts to connect is limited by this setting. After the maximum number of attempts is reached, the image scanner will not attempt to reconnect to the base unit. Pressing the trigger or placing the image scanner in the cradle resets the attempt count and the image scanner will again try to link to the base unit. When set to zero, the image scanner will try to link until the Power Time-Out Timer setting (see [page 3-4](#)) expires.

Scan the **Maximum Link Attempts** barcode, then scan the number of attempts for the setting (from 0-100) from the inside back cover. Scan Save to save the setting. *Default = 0.*



---

## **Relink Time-Out**

Relink Time-Out controls the idle time between re-link attempts. An attempt to link an image scanner to a base unit typically lasts up to 5 seconds. This is the time when the image scanner is actually attempting to contact base unit. Relink Time-Out controls the amount of time, in seconds, that elapses between the end of one connection attempt and the start of the next.

*Note: The length of time for an attempt depends on the number of image scanners connected to a base unit. An extra 7 seconds may be required when a connection is successful.*

Scan the **Relink Time-Out** barcode, then scan the number of seconds for the setting (from 1-100) from the inside back cover. Scan Save to save the setting. *Default = 3 seconds.*



Relink Time-Out

## **Bluetooth/ISM Network Activity Examples**

### **Default values:**

When the image scanner goes out of range, the image scanner repeatedly attempts to connect to base unit. Each attempt consists of approximately 5 seconds of active time followed by 3 seconds of idle time. After one hour, the image scanner powers off and batch mode data is lost.

### **Maximum Link Attempts set to 15**

#### **Other values at default setting:**

When the image scanner goes out of range, 15 attempts are made to link to the base unit. Each attempt consists of approximately 5 seconds of active time followed by 3 seconds of idle time. After 15 cycles ( $8 \times 15 = 120$ ), or about 2 minutes, the image scanner stops trying to connect to the base unit, but retains any barcodes that may have been saved in batch mode. After one hour, the image scanner powers off and batch mode data is lost.

### **Auto Reconnect Mode set to 0**

#### **Maximum Link Attempts set to 15**

#### **Other values at default setting:**

When the image scanner goes out of range, no action is taken to re-link. When the trigger is pulled, 15 attempts are made to link to the base unit. Each attempt consists of approximately 5 seconds of active time followed by 3 seconds of idle time. After 15 cycles ( $8 \times 15 = 120$ ), or about 2 minutes, the image scanner stops trying to connect to the base unit, but retains any barcodes that may have been saved in batch mode. After one hour, the image scanner powers off and batch mode data is lost. Refer to (see [Auto Reconnect Mode](#) on page B-1), to review other events that can start the re-link process.

---

**Auto Reconnect Mode set to 1**  
**Maximum Link Attempts set to 0**  
**Relink Time-Out set to 10**  
**Image Scanner Power Time-Out Timer set to 1800:**

*Note: See [Image Scanner Power Time-Out Timer](#) on page 3-4.*

The image scanner attempts to connect to the base unit every 15 seconds, measured from start of attempt to start of attempt. After one half hour, the image scanner powers off.



---

# Sample Symbols

**UPC A**



0 123456 7890

**Interleaved 2 of 5**



1234567890

**Code 128**



Code 128

**EAN 13**

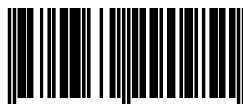

9 780330 290951

**EAN 8**



654 3210 5

**UPC-E**



0 456123 8

---

---

# Sample Symbols

**Code 39**

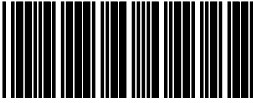

BC321

**Codabar**

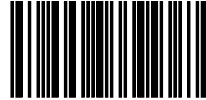

A13579B

**Code 93**



123456-9\$

**Straight 2 of 5 Industrial**

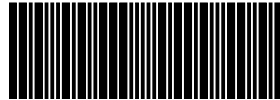

123456

**Matrix 2 of 5**



6543210

**GS1 DataBar**



(01)00123456789012

---

---

# Programming Chart



0



2



4



6



8



A



C



E



1



3



5



7



9



B



D



F



Discard



Save

*Note: If you make an error while scanning the letters or digits (before scanning Save), scan Discard, scan the correct letters or digits, and **Save**.*

**Honeywell**

700 Visions Drive

P.O. Box 208

Skaneateles Falls, NY 13153-0208