

DS6878

PRODUCT REFERENCE GUIDE

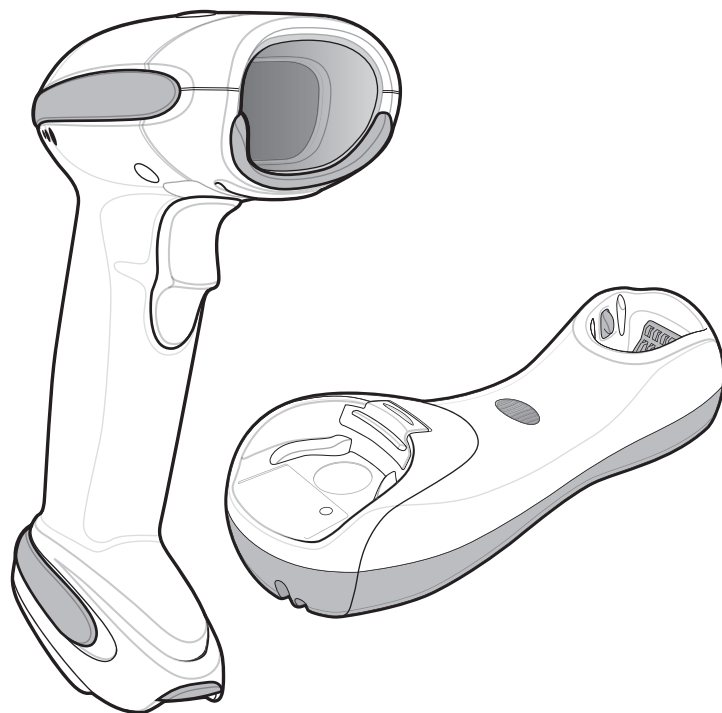

DS6878
PRODUCT REFERENCE GUIDE

72E-131700-08

Revision A

July 2015

No part of this publication may be reproduced or used in any form, or by any electrical or mechanical means, without permission in writing from Zebra. This includes electronic or mechanical means, such as photocopying, recording, or information storage and retrieval systems. The material in this manual is subject to change without notice.

The software is provided strictly on an “as is” basis. All software, including firmware, furnished to the user is on a licensed basis. Zebra grants to the user a non-transferable and non-exclusive license to use each software or firmware program delivered hereunder (licensed program). Except as noted below, such license may not be assigned, sublicensed, or otherwise transferred by the user without prior written consent of Zebra. No right to copy a licensed program in whole or in part is granted, except as permitted under copyright law. The user shall not modify, merge, or incorporate any form or portion of a licensed program with other program material, create a derivative work from a licensed program, or use a licensed program in a network without written permission from Zebra. The user agrees to maintain Zebra’s copyright notice on the licensed programs delivered hereunder, and to include the same on any authorized copies it makes, in whole or in part. The user agrees not to decompile, disassemble, decode, or reverse engineer any licensed program delivered to the user or any portion thereof.

Zebra reserves the right to make changes to any product to improve reliability, function, or design.

Zebra does not assume any product liability arising out of, or in connection with, the application or use of any product, circuit, or application described herein.

No license is granted, either expressly or by implication, estoppel, or otherwise under any Zebra Technologies Corporation, intellectual property rights. An implied license only exists for equipment, circuits, and subsystems contained in Zebra products.

Zebra and the Zebra head graphic are registered trademarks of ZIH Corp. The Symbol logo is a registered trademark of Symbol Technologies, Inc., a Zebra Technologies company. All other trademarks are the property of their respective owners.

This media, or Zebra Product, may include Zebra Software, Commercial Third Party Software, and Publicly Available Software.

The Zebra Software that may be included on this media, or included in the Zebra Product, is Copyright (c) by Zebra Technologies Corporation, and its use is subject to the licenses, terms and conditions of the agreement in force between the purchaser of the Zebra Product and Zebra Technologies Corporation.

The Commercial Third Party Software that may be included on this media, or included in the Zebra Product, is subject to the licenses, terms and conditions of the agreement in force between the purchaser of the Zebra Product and Zebra, Inc., unless a separate Commercial Third Party Software License is included, in which case, your use of the Commercial Third Party Software will then be governed by the separate Commercial Third Party License.

The Publicly Available Software that may be included on this media, or in the Zebra Product, is listed below. The use of the listed Publicly Available Software is subject to the licenses, terms and conditions of the agreement in force between the purchaser of the Zebra Product and Zebra Technologies Corporation, as well as, the terms and conditions of the license of each Publicly Available Software package. Copies of the licenses for the listed Publicly Available Software, as well as, all attributions, acknowledgements, and software information details, are included below. Zebra is required to reproduce the software licenses, acknowledgments and copyright notices as provided by the Authors and Owners, thus, all such information is provided in its native language form, without modification or translation.

The Publicly Available Software in the list below is limited to the Publicly Available Software included by Zebra. The Publicly Available Software included by Commercial Third Party Software or Products, that is used in the Zebra Product, are disclosed in the Commercial Third Party Licenses, or via the respective Commercial Third Party Publicly Available Software Legal Notices.

Publicly available software list:

Name: Regular Expression Evaluator

Version: 8.3

Description: Compiles and executes regular expressions

Software Site: <http://www.freebsd.org/cgi/cvsweb.cgi/src/lib/libc/regex/>

Source Code: No Source Distribution Obligations. Seller will not provide nor distribute the Source Code for the Regular Expression Evaluator.

License: BSD Style License

© 1992 Henry Spencer.

© 1992, 1993 The Regents of the University of California. All rights reserved.

This code is derived from software contributed to Berkeley by Henry Spencer of the University of Toronto. Redistribution and use in source and binary forms, with or without modification, are permitted provided that the following conditions are met:

1. Redistributions of source code must retain the above copyright notice, this list of conditions and the following disclaimer.
2. Redistributions in binary form must reproduce the above copyright notice, this list of conditions and the following disclaimer in the documentation and/or other materials provided with the distribution.
3. All advertising materials mentioning features or use of this software must display the following acknowledgement:

This product includes software developed by the University of California, Berkeley and its contributors.

4. Neither the name of the University nor the names of its contributors may be used to endorse or promote products derived from this software without specific prior written permission.

THIS SOFTWARE IS PROVIDED BY THE REGENTS AND CONTRIBUTORS "AS IS" AND ANY EXPRESS OR IMPLIED WARRANTIES, INCLUDING, BUT NOT LIMITED TO, THE IMPLIED WARRANTIES OF MERCHANTABILITY AND FITNESS FOR A PARTICULAR PURPOSE ARE DISCLAIMED. IN NO EVENT SHALL THE REGENTS OR CONTRIBUTORS BE LIABLE FOR ANY DIRECT, INDIRECT, INCIDENTAL, SPECIAL, EXEMPLARY, OR CONSEQUENTIAL DAMAGES (INCLUDING, BUT NOT LIMITED TO, PROCUREMENT OF SUBSTITUTE GOODS OR SERVICES; LOSS OF USE, DATA, OR PROFITS; OR BUSINESS INTERRUPTION) HOWEVER CAUSED AND ON ANY THEORY OF LIABILITY, WHETHER IN CONTRACT, STRICT LIABILITY, OR TORT (INCLUDING NEGLIGENCE OR OTHERWISE) ARISING IN ANY WAY OUT OF THE USE OF THIS SOFTWARE, EVEN IF ADVISED OF THE POSSIBILITY OF SUCH DAMAGE.

Warranty

For the complete hardware product warranty statement, go to:

<http://www.zebra.com/warranty>.

Revision History

Changes to the original manual are listed below:

Change	Date	Description
-01 Rev A	4/2010	Initial release.
-02 Rev A	3/2011	<p>Add: CR0078-P cradle, FIPS configurations, Imaging Preferences chapter, hands-free scanning instructions, Page Button, Chapter 7: SNAPI Parameters, Simple COM Port Emulation, Quick Keypad Emulation, Polling Interval, French Belgian to USB and KBW chapters, GS1 DataBar Limited Security Level, Move Cursor parameters, PDF417, AZTEC, Micro QR, Micro PDF, Maxicode, Data Matrix, USPS 4CB and UPU FICS Postal, Appendix G: Signature Capture.</p> <p>Correct: 5 Secs parameter in Chapter 5: Timeout to Low Power Mode from Auto Aim, Send Alt 2 and add Send Alt @ parameters in ADF chapter.</p> <p>Remove: Baud Rates: 600, 1200, 2400, and 4800, Stop Bit Select section.</p>
-03 Rev A	1/2012	<p>Add: French International, Timeout Between Decodes: Different Symbols, Presentation Mode Field of View, Australia Post Format, USB Convert Unknown to Code 39, Emulate Keypad with Leading Zero, USB Static CDC.</p> <p>Update: LED indicator definitions; battery specification; Beeper Tone description; Beep on Insertion parameter number; Batch Mode parameter number. Add note to indicate that the default is Enable for HC Configurations and Disable for Non-HC Configurations for the following parameters: GS1 Databar Limited, Composite A/B, Composite C, Datamatrix and Beep on Decoding.</p> <p>Correct: Disable Page Button bar code, Set Pin Code parameter.</p> <p>Remove: Matrix 2 of 5 Redundancy parameter.</p>

Change	Date	Description
-04 Rev A	12/2013	<ul style="list-style-type: none"> - Update URLs. - Remove cradle Wall Mount Bracket Template. - Replaced parameter SSI values with attribute numbers. - Add Apple iOS HID Feature and Android HID Feature. - Add Secure Simple Pairing IO Capability. - Add Connecting an iOS or Android Product With the Digital Scanner. - Add Decode Pager Motor and Decode Pager Motor Duration. - Add Night Mode Trigger and Toggle. - Change Time Delay to Reduced Power Mode to Time Delay to Hand-held Low Power Mode. - Update Timeout Between Decodes, Same Symbol description. - Add Unsolicited Heartbeat Interval. - Add Dump Scanner Parameters. - Add Report Version. - For USB Device Type: <ul style="list-style-type: none"> - Change HID Keyboard Emulation to USB Keyboard (HID). - Change USB OPOS Hand-held to IBM OPOS (IBM Hand-held USB with Full Scan Disable) and added related note. - Change CDC COM Port Emulation to USB CDC Host. - Add SSI over USB CDC and related note. - Update 123Scan2 chapter. - Add Require and Suppress to OCR chapter. - Add OCR-B Variant Travel Document 2 or 3 line ID Cards auto-detect. - Add Multiple Templates section to OCR chapter. - Add Inverse OCR parameter. - Add Separate Transmissions option to UPC/EAN/JAN Supplemental AIM ID Format. - Add Codabar Upper or Lower Case Start/Stop Characters Transmission. - Change GS1 DataBar Limited default to Enable. - Change Security Level default to 1. - Replace ADF chapter content with a reference to the <i>Advanced Data Formatting Programmer Guide</i>. - Update Driver's License Parsing text (jurisdictional updates no longer apply).
-05 Rev A	8/2014	<ul style="list-style-type: none"> - Add Wi-Fi Friendly Mode and Wi-Fi Friendly Channel Exclusion parameters. - Add non-parameter attributes appendix. - Update QR Code sample bar code.
-06 Rev A	12/2014	Zebra rebranding.
-07 Rev A	3/2015	Add Protocol appendix.
-08 Rev A	7/2015	Updated Zebra logo & copyright; fixed TOC link issue; updated 123Scan ² URLs; removed Glossary.

TABLE OF CONTENTS

Warranty	iii
Revision History	iv

About This Guide

Introduction	xix
Configurations	xix
Chapter Descriptions	xx
Notational Conventions	xxi
Related Documents	xxii
Service Information	xxii

Chapter 1: Getting Started

Introduction	1-1
Interfaces	1-2
Unpacking the Digital Scanner and Cradle	1-2
Parts	1-3
Scanner	1-3
CR0078-S/CR0008-S Series Cradle	1-4
CR0078-P Series Cradle	1-6
Digital Scanner Cradle	1-7
Connecting the CR0078-S/CR0008-S Series Cradle	1-8
Supplying Power to the CR0078-S/CR0008-S Cradle	1-9
Using the USB Interface to Supply Power	1-9
Connecting the CR0078-P Series Cradle	1-9
Supplying Power to the CR0078-P Cradle	1-10
Lost Connection to Host	1-10
Mounting the Cradle	1-10
Replacing the Digital Scanner Battery	1-11
Inserting the Digital Scanner in the Cradle	1-12
Inserting Digital Scanner in the CR0078-S/CR0008-S Cradle	1-12
Horizontal Cradle Mount	1-12
Vertical Cradle Mount	1-12

Inserting/Removing Digital Scanner in the CR0078-P Cradle	1-13
Charging the Digital Scanner Battery	1-15
Charging LED	1-15
Shutting Off the Digital Scanner Battery	1-15
Reconditioning the Digital Scanner Battery	1-16
Battery Reconditioning LED Definitions	1-16
Radio Communications	1-17
Configuring the Digital Scanner	1-17
Accessories	1-17
Lanyard	1-17

Chapter 2: Scanning

Introduction	2-1
Beeper Definitions	2-1
LED Definitions	2-3
Scanning	2-5
Hand-held Scanning	2-5
Hands-free Scanning	2-6
Aiming	2-6
Decode Ranges	2-8

Chapter 3: Maintenance, Troubleshooting & Technical Specifications

Introduction	3-1
Maintenance	3-1
Digital Scanner	3-1
Digital Scanner Cradle	3-2
Known Harmful Ingredients	3-2
Daily Cleaning and Disinfecting	3-2
Monthly 'Deep Cleaning' Maintenance	3-3
Battery Information	3-4
Troubleshooting	3-4
Technical Specifications	3-9
Cradle Signal Descriptions	3-12

Chapter 4: Radio Communications

Introduction	4-1
Scanning Sequence Examples	4-1
Errors While Scanning	4-1
Radio Communications Parameter Defaults	4-2
Wireless Beeper Definitions	4-3
Radio Communications Host Types	4-4
Bluetooth Technology Profile Support	4-6
Master/Slave Set Up	4-6
Master	4-6
Slave	4-6
Bluetooth Friendly Name	4-7
Discoverable Mode	4-7
Wi-Fi Friendly Mode	4-8

Notes	4-8
Wi-Fi Friendly Channel Exclusion	4-8
HID Host Parameters	4-10
Apple iOS HID Feature	4-10
Android HID Feature	4-10
HID Country Keyboard Types (Country Codes)	4-11
HID Keyboard Keystroke Delay	4-13
HID CAPS Lock Override	4-13
HID Ignore Unknown Characters	4-14
Emulate Keypad	4-14
HID Keyboard FN1 Substitution	4-15
HID Function Key Mapping	4-15
Simulated Caps Lock	4-16
Convert Case	4-16
Auto-reconnect Feature	4-17
Reconnect Attempt Beep Feedback	4-18
Reconnect Attempt Interval	4-19
Auto-reconnect in Bluetooth Keyboard Emulation (HID Slave) Mode	4-20
Out of Range Indicator	4-20
Digital Scanner(s) To Cradle Support	4-21
Modes of Operation	4-21
Point-to-Point Communication	4-21
Multipoint-to-Point Communication	4-21
Parameter Broadcast (Cradle Host Only)	4-22
Pairing	4-22
Pairing Modes	4-23
Lock Override	4-23
Pairing Methods	4-24
Unpairing	4-24
Pairing Bar Code Format	4-25
Pairing Bar Code Example	4-25
Connection Maintenance Interval	4-26
Considerations	4-26
Page Button	4-28
Bluetooth Security	4-29
Authentication	4-29
PIN Code	4-30
Variable PIN Code	4-30
Encryption	4-31
Secure Simple Pairing IO Capability (SPP Server and SPP Master Host Mode Only)	4-32
Connecting an iOS or Android Product With the Digital Scanner	4-33

Chapter 5: User Preferences & Miscellaneous Digital Scanner Options

Introduction	5-1
Scanning Sequence Examples	5-2
Errors While Scanning	5-2
User Preferences/Miscellaneous Option Parameter Defaults	5-2
User Preferences	5-5
Default Parameters	5-5
Parameter Bar Code Scanning	5-6

Beep After Good Decode	5-6
Suppress Power Up Beeps	5-7
Beeper Tone	5-8
Beeper Volume	5-9
Beeper Duration	5-10
Beep on Insertion	5-10
Decode Pager Motor	5-11
For DS6878-HC units only, manufactured after xx/xx/2013	5-11
Decode Pager Motor Duration	5-11
Night Mode	5-13
For DS6878-HC units only, manufactured after xx/xx/2013	5-13
Night Mode Trigger	5-14
Parameter # 1215	5-14
Night Mode Toggle	5-14
Batch Mode	5-15
Modes of Operation	5-15
Hand-held Trigger Mode	5-17
Hands-free Mode	5-18
Presentation Performance Mode	5-19
Low Power Mode	5-20
Time Delay to Hand-held Low Power Mode	5-20
Digital Scanner Activity Modes	5-22
Time Delay to Presentation Idle Mode	5-23
Time Delay to Presentation Sleep Mode	5-25
Time Delay to Presentation Sleep Mode (continued)	5-26
Timeout to Low Power Mode from Auto Aim	5-27
Picklist Mode	5-28
Mobile Phone/Display Mode	5-29
FIPS Mode	5-30
PDF Prioritization	5-31
PDF Prioritization Timeout	5-31
Continuous Bar Code Read	5-32
Unique Bar Code Reporting	5-32
Decode Session Timeout	5-33
Timeout Between Decodes, Same Symbol	5-33
Timeout Between Decodes, Different Symbols	5-33
Fuzzy 1D Processing	5-34
Hand-held Decode Aiming Pattern	5-34
Hands-free Decode Aiming Pattern	5-35
Presentation Mode Field of View	5-36
Decoding Illumination	5-37
Multicode Mode	5-37
Multicode Expression	5-38
Multicode Expression Syntax	5-38
Defining Multicode Expression Notes	5-39
Multicode Mode Concatenation	5-43
Multicode Concatenation Symbology	5-44
Multicode Troubleshooting	5-45
Troubleshooting Multicode Expression Programming	5-45
Troubleshooting Multicode Mode Scanning and Decoding	5-45
Miscellaneous Scanner Parameters	5-47

Transmit Code ID Character	5-47
Prefix/Suffix Values	5-48
Scan Data Transmission Format	5-49
FN1 Substitution Values	5-50
Transmit "No Read" Message	5-51
Unsolicited Heartbeat Interval	5-52
Dump Scanner Parameters	5-53
Report Version	5-53

Chapter 6: Imaging Preferences

Introduction	6-1
Scanning Sequence Examples	6-2
Errors While Scanning	6-2
Imaging Preferences Parameter Defaults	6-2
Imaging Preferences	6-4
Operational Modes	6-4
Decode Mode	6-4
Snapshot Mode	6-4
Image Capture Illumination	6-5
Gain/Exposure Priority for Snapshot Mode	6-6
Snapshot Mode Timeout	6-7
Snapshot Aiming Pattern	6-7
Image Cropping	6-7
Crop to Pixel Addresses	6-8
Image Size (Number of Pixels)	6-9
Image Brightness (Target White)	6-10
JPEG Image Options	6-10
JPEG Target File Size	6-11
JPEG Quality and Size Value	6-11
Image Enhancement	6-12
Image File Format Selector	6-13
Image Rotation	6-14
Bits Per Pixel	6-15
Signature Capture	6-16
Output File Format	6-16
Signature Capture File Format Selector	6-17
Signature Capture Bits Per Pixel	6-18
Signature Capture Width	6-19
Signature Capture Height	6-19
Signature Capture JPEG Quality	6-19

Chapter 7: USB Interface

Introduction	7-1
Connecting a USB Interface	7-2
USB Parameter Defaults	7-4
USB Host Parameters	7-5
USB Device Type	7-5
Symbol Native API (SNAPI) Status Handshaking	7-7
USB Country Keyboard Types - Country Codes	7-8

USB Keystroke Delay	7-10
USB CAPS Lock Override	7-10
USB Ignore Unknown Characters	7-11
USB Convert Unknown to Code 39	7-11
Emulate Keypad	7-12
Emulate Keypad with Leading Zero	7-12
Quick Keypad Emulation	7-13
USB Keyboard FN 1 Substitution	7-13
USB Static CDC	7-14
Function Key Mapping	7-14
Simulated Caps Lock	7-15
Convert Case	7-15
Optional USB Parameters	7-16
Ignore Beep	7-16
Ignore Bar Code Configuration	7-16
USB Polling Interval	7-17
ASCII Character Set for USB	7-19

Chapter 8: RS-232 Interface

Introduction	8-1
Connecting an RS-232 Interface	8-2
RS-232 Parameter Defaults	8-3
RS-232 Host Parameters	8-4
RS-232 Host Types	8-6
Baud Rate	8-8
Parity	8-9
Data Bits (ASCII Format)	8-9
Check Receive Errors	8-10
Hardware Handshaking	8-10
Software Handshaking	8-12
Host Serial Response Time-out	8-14
RTS Line State	8-15
Beep on <BEL>	8-15
Intercharacter Delay	8-16
Nixdorf Beep/LED Options	8-17
Ignore Unknown Characters	8-17
ASCII Character Set for RS-232	8-18

Chapter 9: Keyboard Wedge Interface

Introduction	9-1
Connecting a Keyboard Wedge Interface	9-2
Keyboard Wedge Parameter Defaults	9-3
Keyboard Wedge Host Parameters	9-4
Keyboard Wedge Host Types	9-4
Keyboard Wedge Country Types (Country Codes)	9-5
Ignore Unknown Characters	9-7
Keystroke Delay	9-7
Intra-Keystroke Delay	9-8
Alternate Numeric Keypad Emulation	9-8

Caps Lock On	9-9
Caps Lock Override	9-9
Convert Wedge Data	9-10
Function Key Mapping	9-10
FN1 Substitution	9-11
Send Make and Break	9-11
Keyboard Map	9-12
ASCII Character Set for Keyboard Wedge	9-13

Chapter 10: IBM Interface

Introduction	10-1
Connecting to an IBM 468X/469X Host	10-2
IBM 468X/469X Parameter Defaults	10-3
IBM 468X/469X Host Parameters	10-4
Port Address	10-4
Convert Unknown to Code 39	10-5
Optional IBM Parameters	10-6
Ignore Beep	10-6
Ignore Bar Code Configuration	10-6

Chapter 11: Wand Emulation Interface

Introduction	11-1
Connecting Using Wand Emulation	11-2
Wand Emulation Parameter Defaults	11-3
Wand Emulation Host Parameters	11-4
Wand Emulation Host Types	11-4
Leading Margin (Quiet Zone)	11-4
Polarity	11-5
Ignore Unknown Characters	11-5
Convert All Bar Codes to Code 39	11-6
Convert Code 39 to Full ASCII	11-6

Chapter 12: Scanner Emulation Interface

Connecting Using Scanner Emulation	12-2
Scanner Emulation Parameter Defaults	12-3
Scanner Emulation Host	12-3
Scanner Emulation Host Parameters	12-4
Beep Style	12-4
Parameter Pass-Through	12-5
Convert Newer Code Types	12-6
Module Width	12-6
Convert All Bar Codes to Code 39	12-7
Code 39 Full ASCII Conversion	12-7
Transmission Timeout	12-8
Ignore Unknown Characters	12-9
Leading Margin	12-9
Check For Decode LED	12-10

Chapter 13: 123Scan2

Introduction	13-1
Communication with 123Scan2	13-1
123Scan2 Requirements	13-2
Scanner SDK, Other Software Tools, and Videos	13-2

Chapter 14: OCR Programming

Introduction	14-1
OCR Parameter Defaults	14-2
OCR Programming Parameters	14-3
Enable/Disable OCR-A	14-3
OCR-A Variant	14-3
Enable/Disable OCR-B	14-5
OCR-B Variant	14-6
Enable/Disable MICR E13B	14-9
Enable/Disable US Currency Serial Number	14-10
OCR Orientation	14-10
OCR Lines	14-12
OCR Minimum Characters	14-12
OCR Maximum Characters	14-13
OCR Security Level	14-13
OCR Subset	14-14
OCR Quiet Zone	14-14
OCR Bright Illumination	14-15
OCR Template	14-16
Required Digit (9)	14-16
Required Alpha (A)	14-16
Require and Suppress (0)	14-17
Optional Alphanumeric (1)	14-17
Optional Alpha (2)	14-17
Alpha or Digit (3)	14-17
Any Including Space & Reject (4)	14-18
Any except Space & Reject (5)	14-18
Optional Digit (7)	14-18
Digit or Fill (8)	14-19
Alpha or Fill (F)	14-19
Required Space ()	14-19
Optional Small Special (.)	14-20
Other Template Operators	14-20
Repeat Previous (R)	14-24
Multiple Templates	14-25
Template Examples	14-25
OCR Check Digit Modulus	14-25
OCR Check Digit Multiplier	14-26
OCR Check Digit Validation	14-27
None	14-27
Product Add Left to Right	14-27
Product Add Right to Left	14-28
Digit Add Left to Right	14-28
Digit Add Right to Left	14-29

Product Add Right to Left Simple Remainder	14-30
Digit Add Right To Left Simple Remainder	14-31
Health Industry - HIBCC43	14-31
Inverse OCR	14-32

Chapter 15: Symbologies

Introduction	15-1
Scanning Sequence Examples	15-1
Errors While Scanning	15-2
Symbology Parameter Defaults	15-2
UPC/EAN	15-7
Enable/Disable UPC-A	15-7
Enable/Disable UPC-E	15-7
Enable/Disable UPC-E1	15-8
Enable/Disable EAN-8/JAN-8	15-8
Enable/Disable EAN-13/JAN-13	15-9
Enable/Disable Bookland EAN	15-9
Decode UPC/EAN/JAN Supplementals	15-10
User-Programmable Supplementals	15-13
UPC/EAN/JAN Supplemental Redundancy	15-13
UPC/EAN/JAN Supplemental AIM ID Format	15-14
Transmit UPC-A Check Digit	15-15
Transmit UPC-E Check Digit	15-15
Transmit UPC-E1 Check Digit	15-16
UPC-A Preamble	15-16
UPC-E Preamble	15-17
UPC-E1 Preamble	15-18
Convert UPC-E to UPC-A	15-19
Convert UPC-E1 to UPC-A	15-19
EAN-8/JAN-8 Extend	15-20
Bookland ISBN Format	15-20
UCC Coupon Extended Code	15-21
Coupon Report	15-22
ISSN EAN	15-22
Code 128	15-23
Enable/Disable Code 128	15-23
Set Lengths for Code 128	15-23
Enable/Disable GS1-128 (formerly UCC/EAN-128)	15-25
Enable/Disable ISBT 128	15-25
ISBT Concatenation	15-26
Check ISBT Table	15-27
ISBT Concatenation Redundancy	15-27
Code 39	15-28
Enable/Disable Code 39	15-28
Enable/Disable Trioptic Code 39	15-28
Convert Code 39 to Code 32	15-29
Code 32 Prefix	15-29
Set Lengths for Code 39	15-30
Code 39 Check Digit Verification	15-31
Transmit Code 39 Check Digit	15-31

Code 39 Full ASCII Conversion	15-32
Code 39 Buffering - Scan & Store	15-32
Buffer Data	15-33
Clear Transmission Buffer	15-33
Transmit Buffer	15-34
Overfilling Transmission Buffer	15-34
Attempt to Transmit an Empty Buffer	15-34
Code 93	15-35
Enable/Disable Code 93	15-35
Set Lengths for Code 93	15-35
Code 11	15-37
Code 11	15-37
Set Lengths for Code 11	15-37
Code 11 Check Digit Verification	15-39
Transmit Code 11 Check Digits	15-40
Interleaved 2 of 5 (ITF)	15-41
Enable/Disable Interleaved 2 of 5	15-41
Set Lengths for Interleaved 2 of 5	15-41
I 2 of 5 Check Digit Verification	15-43
Transmit I 2 of 5 Check Digit	15-43
Convert I 2 of 5 to EAN-13	15-44
Discrete 2 of 5 (DTF)	15-44
Enable/Disable Discrete 2 of 5	15-44
Set Lengths for Discrete 2 of 5	15-45
Codabar (NW - 7)	15-47
Enable/Disable Codabar	15-47
Set Lengths for Codabar	15-47
CLSI Editing	15-49
NOTIS Editing	15-49
Codabar Upper or Lower Case Start/Stop Characters Transmission	15-50
MSI	15-51
Enable/Disable MSI	15-51
Set Lengths for MSI	15-51
MSI Check Digits	15-53
Transmit MSI Check Digit(s)	15-53
MSI Check Digit Algorithm	15-54
Chinese 2 of 5	15-54
Enable/Disable Chinese 2 of 5	15-54
Matrix 2 of 5	15-55
Enable/Disable Matrix 2 of 5	15-55
Set Lengths for Matrix 2 of 5	15-56
Matrix 2 of 5 Check Digit	15-57
Transmit Matrix 2 of 5 Check Digit	15-57
Korean 3 of 5	15-58
Enable/Disable Korean 3 of 5	15-58
Inverse 1D	15-59
Postal Codes	15-60
US Postnet	15-60
US Planet	15-60
Transmit US Postal Check Digit	15-61
UK Postal	15-61

Transmit UK Postal Check Digit	15-62
Japan Postal	15-62
Australia Post	15-63
Australia Post Format	15-64
Netherlands KIX Code	15-65
USPS 4CB/One Code/Intelligent Mail	15-65
UPU FICS Postal	15-66
GS1 DataBar	15-67
GS1 DataBar-14	15-67
GS1 DataBar Limited	15-67
GS1 DataBar Expanded	15-68
GS1 DataBar Limited Security Level	15-69
Convert GS1 DataBar to UPC/EAN	15-70
Composite	15-71
Composite CC-C	15-71
Composite CC-A/B	15-71
Composite TLC-39	15-72
UPC Composite Mode	15-72
Composite Beep Mode	15-73
GS1-128 Emulation Mode for UCC/EAN Composite Codes	15-73
2D Symbologies	15-74
Enable/Disable PDF417	15-74
Enable/Disable MicroPDF417	15-74
Code 128 Emulation	15-75
Data Matrix	15-76
Data Matrix Inverse	15-76
Maxicode	15-77
QR Code	15-77
QR Inverse	15-78
MicroQR	15-78
Aztec	15-79
Aztec Inverse	15-79
Redundancy Level	15-80
Redundancy Level 1	15-80
Redundancy Level 2	15-80
Redundancy Level 3	15-80
Redundancy Level 4	15-81
Security Level	15-82
Intercharacter Gap Size	15-83
Report Version	15-83
Macro PDF Features	15-84
Flush Macro Buffer	15-84
Abort Macro PDF Entry	15-84

Chapter 16: Advanced Data Formatting

Introduction	16-1
--------------------	------

Chapter 17: Driver's License Set Up (DS6878-DL)

Introduction	17-1
DL Parsing Parameter Defaults	17-2
Driver's License Parsing	17-3
Parsing Driver's License Data Fields (Embedded Driver's License Parsing)	17-3
Embedded Driver's License Parsing Criteria - Code Type	17-3
Driver's License Parse Field Bar Codes	17-4
AAMVA Parse Field Bar Codes	17-7
User Preferences	17-17
Set Default Parameter	17-17
Output Gender as M or F	17-17
Date Format	17-18
No Separator	17-19
Send Keystroke (Control Characters and Keyboard Characters)	17-20
Control Characters	17-20
Keyboard Characters	17-24
Parsing Rule Example	17-39
Embedded Driver's License Parsing ADF Example	17-43

Appendix A: Standard Default Parameters**Appendix B: Programming Reference**

Symbol Code Identifiers	B-1
AIM Code Identifiers	B-3

Appendix C: Sample Bar Codes

Code 39	C-1
UPC/EAN	C-1
UPC-A, 100%	C-1
EAN-13, 100%	C-2
Code 128	C-2
Interleaved 2 of 5	C-2
GS1 DataBar	C-3
GS1 DataBar-14	C-4
PDF417	C-4
Data Matrix	C-4
Maxicode	C-5
QR Code	C-5
US Postnet	C-5
UK Postal	C-5

Appendix D: Numeric Bar Codes

Numeric Bar Codes	D-1
Cancel	D-2

Appendix E: Alphanumeric Bar Codes

Alphanumeric Keyboard	E-1
-----------------------------	-----

Appendix F: ASCII Character Sets**Appendix G: Communication Protocol Functionality**

Functionality Supported via Communication (Cable) Interface	G-1
DS6878 with CR0078-S (Standard Cradle)	G-1
DS6878 with CR0078-P (Presentation Cradle)	G-3

Appendix H: Signature Capture Code

Introduction	H-1
Code Structure	H-1
Signature Capture Area	H-1
CapCode Pattern Structure	H-2
Start / Stop Patterns	H-2
Dimensions	H-3
Data Format	H-3
Additional Capabilities	H-4
Signature Boxes	H-4

Appendix I: Non-Parameter Attributes

Introduction	I-1
Attributes	I-1
Model Number	I-1
Serial Number	I-1
Date of Manufacture	I-2
Date of First Programming	I-2
Configuration Filename	I-2
Night Mode	I-2
Pager Motor On Scanner	I-3
Beeper/LED	I-3
Parameter Defaults	I-4
Beep on Next Bootup	I-4
Reboot	I-4
Host Trigger Session	I-4
Firmware Version	I-5
Scankit Version	I-5
Imagekit Version	I-5
In Cradle Detection	I-5
Operational Mode	I-6

Index

ABOUT THIS GUIDE

Introduction

The *DS6878 Product Reference Guide* provides general instructions for setting up, operating, maintaining, and troubleshooting the DS6878 digital scanner and cradles.

Configurations

This guide includes the following configurations:

- DS6878-SR20001WR - DS6878 digital scanner, standard range, cash register white
- DS6878-SR20007WR - DS6878 digital scanner, standard range, twilight black
- DS6878-SR2F001WR - DS6878 digital scanner, standard range, FIPS, cash register white
- DS6878-SR2F007WR - DS6878 digital scanner, standard range, FIPS, twilight black
- DS6878-HC2000BWR - DS6878 digital scanner, standard range, healthcare white
- DS6878-HC2F09BWR - DS6878 digital scanner, standard range, FIPS, healthcare white
- DS6878-DL20001WR - DS6878 digital scanner, standard range, DL parsing, cash register white
- DS6878-DL20007WR - DS6878 digital scanner, standard range, DL parsing, twilight black
- DS6878-HD20007WR - DS6878 digital scanner, high density, twilight black

Chapter Descriptions

Topics covered in this guide are as follows:

- [Chapter 1, Getting Started](#) provides a product overview, unpacking instructions, and cable connection information.
- [Chapter 2, Scanning](#) describes parts of the digital scanner, beeper and LED definitions, and how to use the digital scanner.
- [Chapter 3, Maintenance, Troubleshooting & Technical Specifications](#) provides information on how to care for the digital scanner and cradle, troubleshooting, and technical specifications.
- [Chapter 4, Radio Communications](#) provides information about the modes of operation and features available for wireless communication. This chapter also includes programming bar codes to configure the digital scanner.
- [Chapter 5, User Preferences & Miscellaneous Digital Scanner Options](#) provides programming bar codes for selecting user preference features for the digital scanner and commonly used bar codes to customize how the data is transmitted to the host device.
- [Chapter 6, Imaging Preferences](#) provide imaging preference features and programming bar codes for selecting these items.
- [Chapter 7, USB Interface](#) provides information for setting up the digital scanner and cradle for USB operation.
- [Chapter 8, RS-232 Interface](#) provides information for setting up the digital scanner and cradle for RS-232 operation.
- [Chapter 9, Keyboard Wedge Interface](#) provides information for setting up the digital scanner and cradle for Keyboard Wedge operation.
- [Chapter 10, IBM Interface](#) provides all information for setting up the digital scanner and cradle with IBM 468X/469X POS systems.
- [Chapter 11, Wand Emulation Interface](#) provides all information for setting up the digital scanner and cradle for Wand Emulation operation.
- [Chapter 12, Scanner Emulation Interface](#) provides information for setting up the digital scanner and cradle for Scanner Emulation operation.
- [Chapter 13, 123Scan2](#) (PC based scanner configuration tool) enables rapid and easy customized setup of Zebra scanners.
- [Chapter 14, OCR Programming](#) describes how to set up the digital scanner for OCR programming.
- [Chapter 15, Symbologies](#) describes all symbology features and provides the programming bar codes necessary for selecting these features for the digital scanner.
- [Chapter 16, Advanced Data Formatting](#) (ADF) describes how to customize scanned data before transmitting to the host. This chapter also contains the bar codes for advanced data formatting.
- [Chapter 17, Driver's License Set Up \(DS6878-DL\)](#) describes how the DS6878-DL digital scanner can parse out information from the standard US driver's licenses and certain other American Association of Motor Vehicle Administrators (AAMVA) compliant ID cards.
- [Appendix A, Standard Default Parameters](#) provides a table of all host devices and miscellaneous digital scanner defaults.
- [Appendix B, Programming Reference](#) provides a table of AIM code identifiers, ASCII character conversions, and keyboard maps.

- [Appendix C, Sample Bar Codes](#) includes sample bar codes.
- [Appendix D, Numeric Bar Codes](#) includes the numeric bar codes to scan for parameters requiring specific numeric values.
- [Appendix E, Alphanumeric Bar Codes](#) includes the bar codes representing the alphanumeric keyboard, used when setting ADF rules.
- [Appendix F, ASCII Character Sets](#) provides ASCII character value tables.
- [Appendix G, Communication Protocol Functionality](#) lists supported scanner functionality by communication protocol.
- [Appendix H, Signature Capture Code](#) provides information on CapCode, a signature capture code that encloses a signature area on a document and allows a scanner to capture a signature.
- [Appendix I, Non-Parameter Attributes](#) provides non-parameter attribute numbers and descriptions.

Notational Conventions

The following conventions are used in this document:

- *Italics* are used to highlight chapters and sections in this and related documents.
- **Bold** text is used to highlight parameter names and options.
- bullets (•) indicate:
 - Action items
 - Lists of alternatives
 - Lists of required steps that are not necessarily sequential
- Sequential lists (e.g., those that describe step-by-step procedures) appear as numbered lists.
- Throughout the programming bar code menus, asterisks (*) are used to denote default parameter settings.

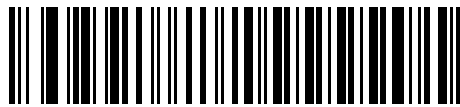

* Indicates Default — ***Baud Rate 9600** — Feature/Option



NOTE This symbol indicates something of special interest or importance to the reader. Failure to read the note will not result in physical harm to the reader, equipment or data.



CAUTION This symbol indicates that if this information is ignored, the possibility of data or material damage may occur.



WARNING! This symbol indicates that if this information is ignored the possibility that serious personal injury may occur.

Related Documents

- The *DS6878 Quick Start Guide* (p/n 72-131700-xx) provides general information to help the user get started with the digital scanner. It includes basic operation instructions and start up bar codes.
- The *CR0078-S/CR0008-S Cradle Quick Reference Guide* (p/n 72-135874-xx) provides information to help the user set up and use the charge only and host interface cradles. It includes set up and mounting instructions.
- The *CR0078-P Cradle Quick Reference Guide* (p/n 72-138860-xx) provides general information regarding the cradle. It includes set up and usage instructions.

The latest version of this guide and all guides are available at: www.zebra.com/support.

Service Information

If you have a problem using the equipment, contact your facility's technical or systems support. If there is a problem with the equipment, they will contact the Customer Support Center at: www.zebra.com/support.

When contacting support, please have the following information available:

- Serial number of the unit
- Model number or product name
- Software type and version number.

Zebra responds to calls by e-mail, telephone or fax within the time limits set forth in service agreements. If your problem cannot be solved by support, you may need to return your equipment for servicing and will be given specific directions. Zebra is not responsible for any damages incurred during shipment if the approved shipping container is not used. Shipping the units improperly can possibly void the warranty.

If you purchased your business product from a Zebra business partner, please contact that business partner for support.

CHAPTER 1 GETTING STARTED

Introduction

The DS6878 combines superior 1D and 2D omnidirectional bar code scanning performance and advanced ergonomics in a light-weight design. The digital scanner ensures comfort and ease of use for extended periods of time.



Figure 1-1 *DS6878 Digital Scanner*

Interfaces

The CR0078-S cradle supports all of the following interfaces. The CR0078-P cradle supports all of the interfaces listed below with the exception of Wand Emulation, Scanner Emulation, and Synapse:

- USB connection to a host. The cradle auto detects a USB host and defaults to the HID keyboard interface type. Select other USB interface types by scanning programming bar code menus. This interface supports the following international keyboards (for Windows® environment): North America, German, French, French Canadian, Spanish, Italian, Swedish, UK English, Brazilian Portuguese, and Japanese.
- Standard RS-232 connection to a host. Scan bar code menus to set up proper communication of the cradle with the host.
- Keyboard Wedge connection to a host. The host interprets scanned data as keystrokes. This interface supports the following international keyboards (for Windows® environment): North America, German, French, French Canadian, Spanish, Italian, Swedish, UK English, Portuguese-Brazilian, and Japanese.
- Connection to IBM® 468X/469X hosts. Scan bar code menus to set up communication of the cradle with the IBM terminal.
- Wand Emulation connection to a host. The cradle (CR0078-S only; CR0078-P does not support Wand Emulation) is connected to a portable data terminal, a controller, or host which collects the data as wand data and decodes it.
- Scanner Emulation connection to a host. The cradle (CR0078-S only; CR0078-P does not support Scanner Emulation) is connected to a portable data terminal, a controller which collects the data and interprets it for the host.
- Synapse capability which allows connection to a wide variety of host systems using a Synapse and Synapse adapter cable (CR0078-S only; CR0078-P does not support Synapse). The cradle auto detects the host.
- Configuration via 123Scan².

✓ **NOTE** Only the Symbol Native API (SNAPI) interface supports image capture. See [USB Device Type on page 7-5](#) to enable this host.

✓ **NOTE** For a list of supported scanner functionality by communication protocol, see [Appendix G, Communication Protocol Functionality](#).

Unpacking the Digital Scanner and Cradle

Remove the digital scanner and cradle from their respective packing and inspect for damage. If the digital scanner or cradle was damaged in transit, contact Support. See [page xxiv](#) for contact information. **KEEP THE PACKING.** It is the approved shipping container and should be used if the equipment ever needs to be returned for servicing.

Parts

Scanner

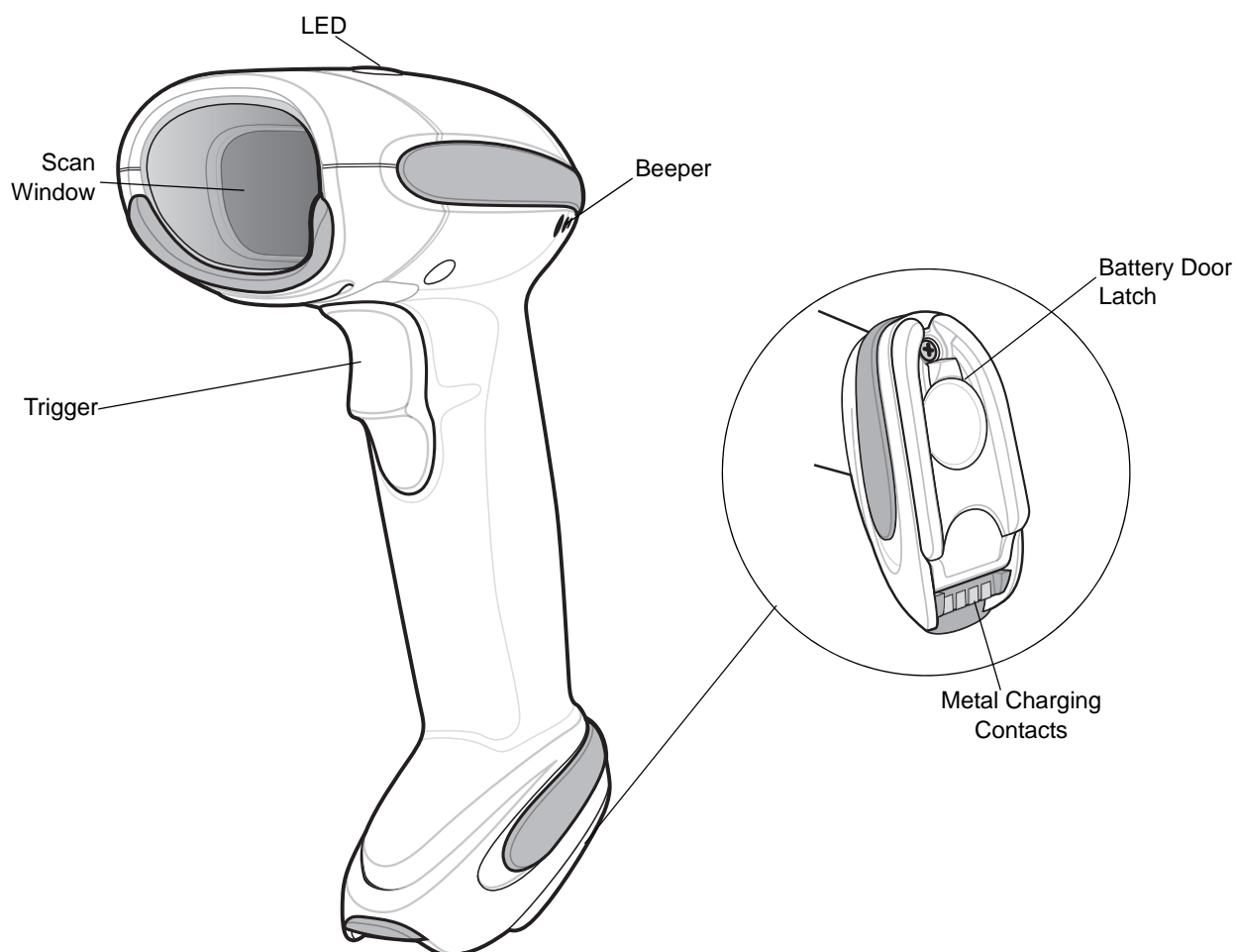

Figure 1-2 *Parts of the Digital Scanner*

CR0078-S/CR0008-S Series Cradle

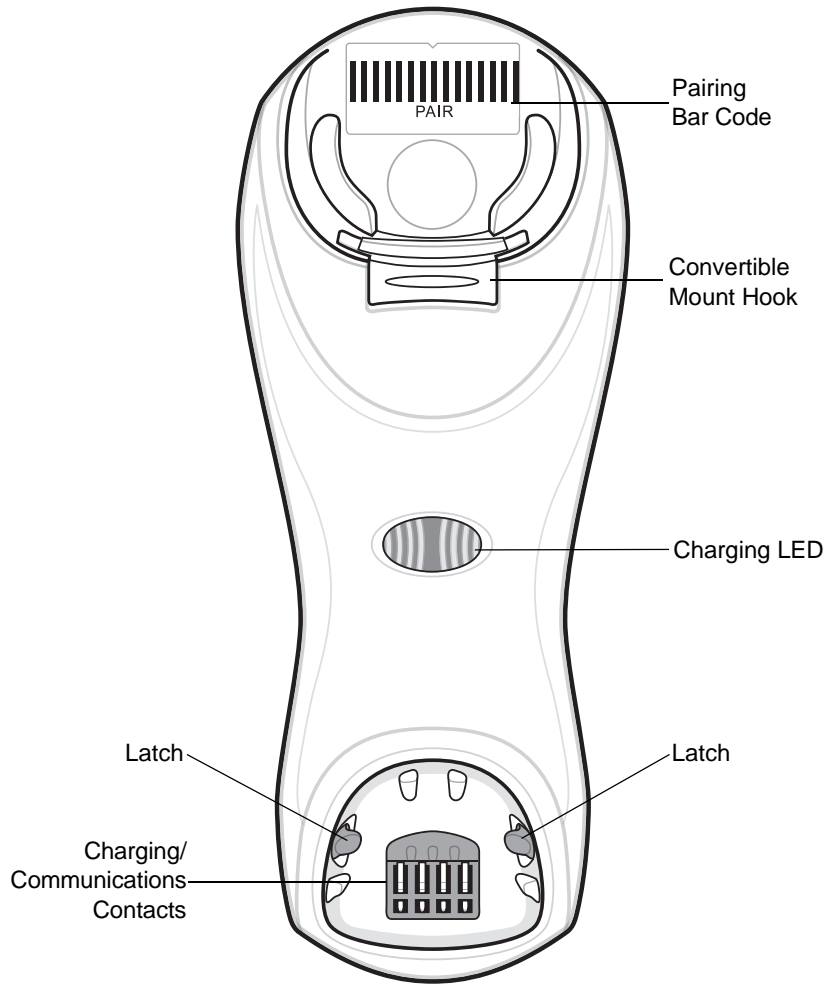

Figure 1-3 CR0078-S/CR0008-S Series Cradle Front View

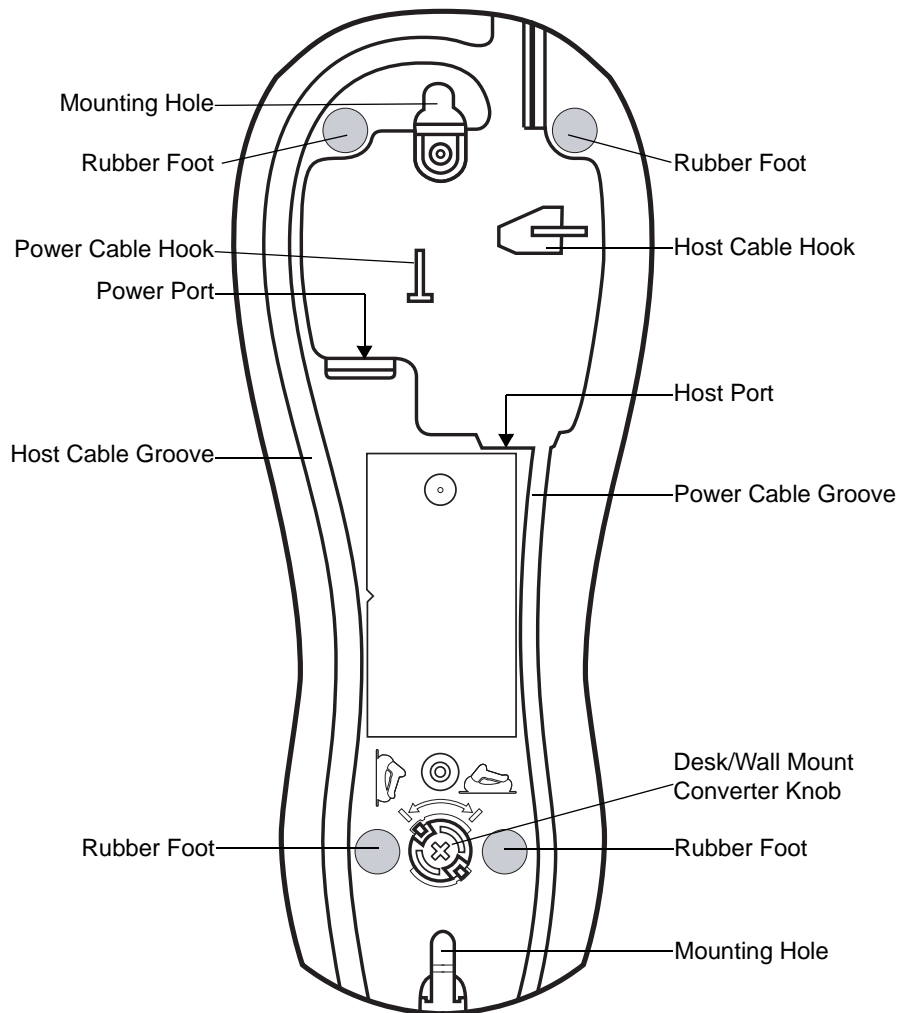

Figure 1-4 CR0078-S/CR0008-S Series Cradle Back View

CR0078-P Series Cradle

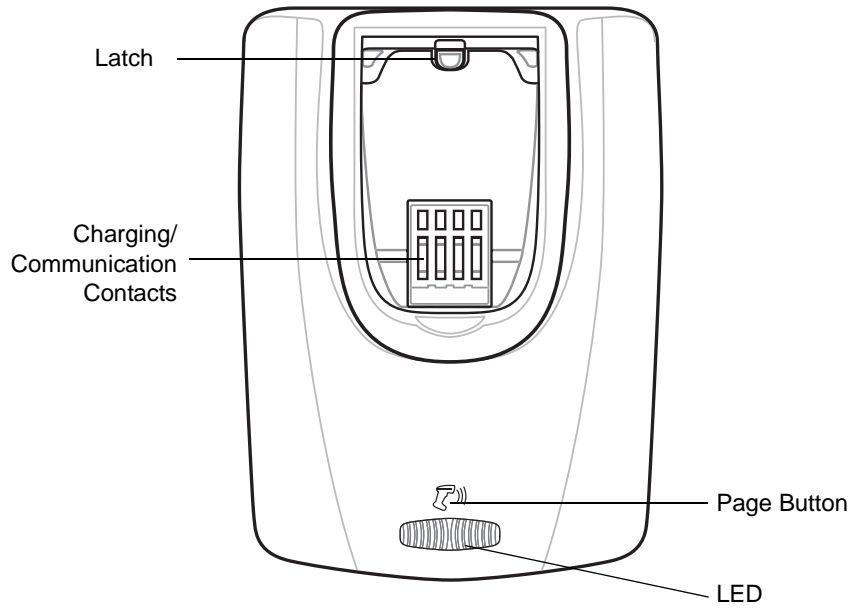

Figure 1-5 CR0078-P Cradle Front View

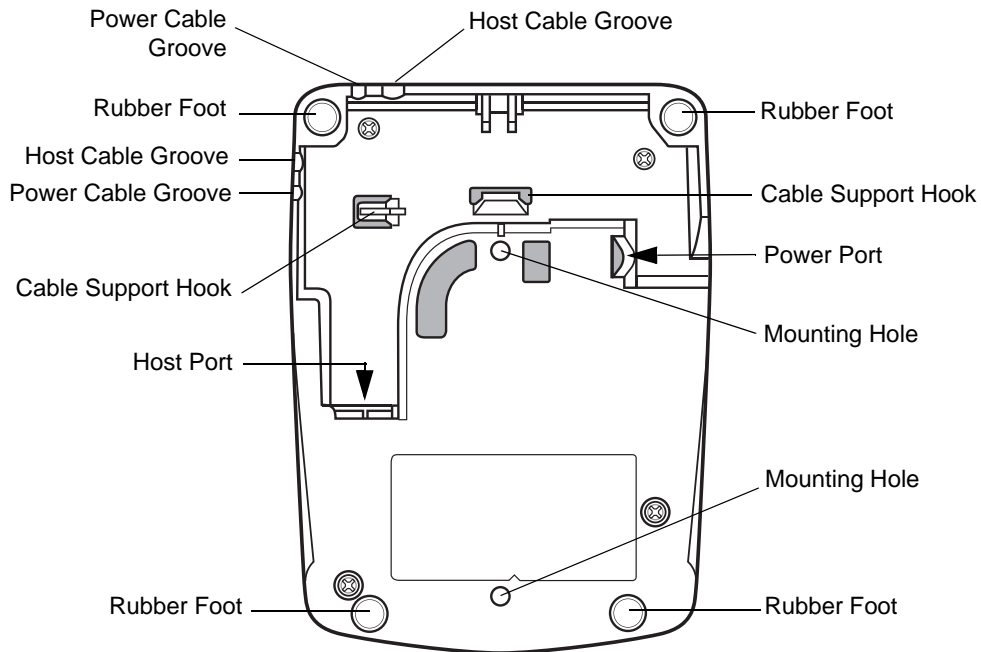

Figure 1-6 CR0078-P Cradle Back View

Digital Scanner Cradle

The digital scanner cradles CR0078-S and CR0078-P serve as a stand, charger, and host interface for the digital scanner. The cradle sits on a desktop. The CR0078-S cradle can also be mounted on a vertical surface (such as a wall). For more information about mounting options and procedures, refer to the documentation included with the cradle.

The CR0078-S cradle is available as a charging cradle with a radio and as a charge-only cradle. The CR0078-P cradle is only available as a charging cradle with a radio. The differences between the two versions are as follows:

- **Charging cradle with radio:** When the cordless digital scanner is paired to the cradle, all communication between the digital scanner and the host computer is accomplished through the cradle. Each bar code contains programming instructions or other data unique to the bar code pattern. The digital scanner is paired to the cradle and transmits bar code data to the cradle via Bluetooth Technology Profile Support. The cradle then sends that information via an interface cable to the host computer for interpretation.
- **Charge-only cradle:** This cradle serves as a stand and battery charger. It does not contain a radio and has no communication capability.

✓ **NOTE** For more information about communication between the digital scanner, cradle, and host, see [Chapter 4, Radio Communications](#).

[Table 1-1](#) outlines several main differences between the CR0078-S and CR0078-P cradles:

Table 1-1 Cradle Features

Feature	CR0078-S	CR0078-P
Scanning	Hand-held scanning	Hands-free or hand-held scanning
Bluetooth	Bluetooth or Charge Only (CR0008-S)	Bluetooth
Pairing	Pair up to 3 scanners per cradle	Pair up to 7 scanners per cradle
Paging	Not available	Ability to page misplaced scanner(s)
Charging	Charges via USB with no power supply required; requires ferrite if used with a 5V power supply in a healthcare environment	Requires 12V power supply
Interfaces	Supports most commonly used interfaces (see Technical Specifications on page 3-9 for detailed list)	Supports most commonly used interfaces with the exception of Wand Emulation, Scanner Emulation and Synapse
FIPS	Not available	FIPS140-2 wireless security
USB Cable	Standard universal USB cable	Requires universal cables with shielded modular plugs
Image Capture	Not available	Supported via SNAPI
OCR/MICR	Not available	Supported via SNAPI

Connecting the CR0078-S/CR0008-S Series Cradle

Connect the interface cable and power supply (if necessary) in the following order to ensure proper operation of the digital scanner and cradle:

- ✓ **NOTE** The CR0078-S cradle has the ability to be powered by the USB port instead of an external power supply. The CR0078-P can only receive power via an external power supply.

1. If a power supply is connected to the cradle, disconnect it.
2. If using an interface cable, insert the cable into the cradle's host port. See [Figure 1-7](#).
3. If using a power supply that connects to the interface cable, insert this power supply into the power connector on the interface cable, and the other end to an AC supply.
4. Insert the other end of the interface cable into the appropriate port on the host computer (see the specific host chapter for information on host connections).
5. If using an external power supply (if required by the interface or to allow fast charging of the digital scanner), insert the power cable into the power port on the back of the cradle, and connect the power supply to an approved AC supply (refer to the *CR0078-S/CR0008-S Cradle Quick Reference Guide* for more information).

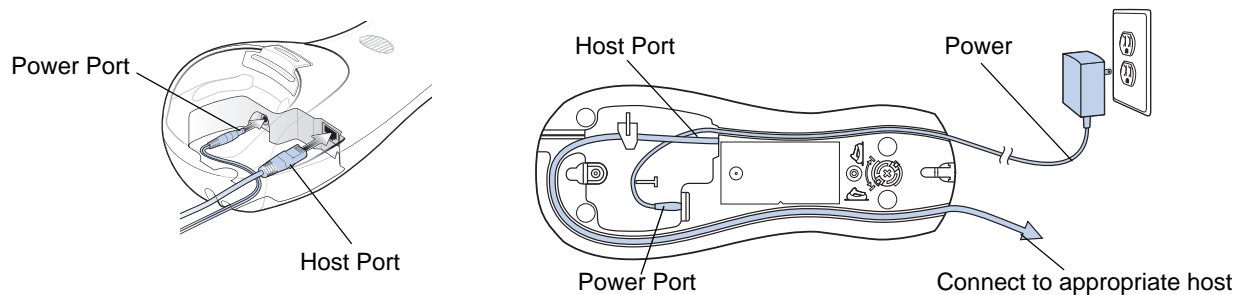

Figure 1-7 Connecting the Cables to the CR0078-S/CR0008-S Cradle

6. If applicable, thread the interface cable over the cable support hook and run the host and power cables into their respective cable grooves.
7. Mount the cradle, as necessary. (For information on mounting the cradle, refer to the documentation included with the cradle.)

- ✓ **NOTE** Disconnect the power supply before changing host cables or the cradle may not recognize the new host. Different cables are required for different hosts. The connectors illustrated in each host chapter are examples only. The connectors may be different from those illustrated, but the steps to connect the cradle remain the same.

Supplying Power to the CR0078-S/CR0008-S Cradle

The CR0078-S/CR0008-S cradle receives power from one of two sources:

- An external power supply.
- When connected to the host through a host cable that supplies power (CR0078-S only).

The cradle detects whether the host or the external supply is supplying power. It always draws power from the external supply when available, regardless of the presence of power from a host.



IMPORTANT For healthcare environments, use cradle p/n CR0078-SC1009BWR and place the ferrite core (included in box with cradle) on the power supply (refer to the *Power Supply Ferrite Installation* instructions included in the box).

Using the USB Interface to Supply Power

When the CR0078-S cradle is connected to the host via the USB interface, it can be powered by the USB port instead of an external power supply. Powering from a USB host limits charging. The digital scanner charges at a slower rate than when charging from an external power supply.



NOTE The radio link functions normally when the cradle draws power from a USB host.

Connecting the CR0078-P Series Cradle

Connect the interface cable and power supply (if necessary) in the following order to ensure proper operation of the digital scanner and cradle:

1. Insert the interface cable into the cradle's host port.
2. Connect the other end of the interface cable to the host.
3. Connect the power supply to the cradle's power port.
4. Connect the appropriate cable to the power supply and AC power source.
5. Thread the interface cable over the cable support hook (see [Figure 1-6 on page 1-6](#)) and run the host and power cables into their respective cable grooves.

- If necessary (for non-autodetected interfaces), scan the appropriate host bar code (refer to the *CR0078-S/CR0008-S Cradle Quick Reference Guide* for more information).

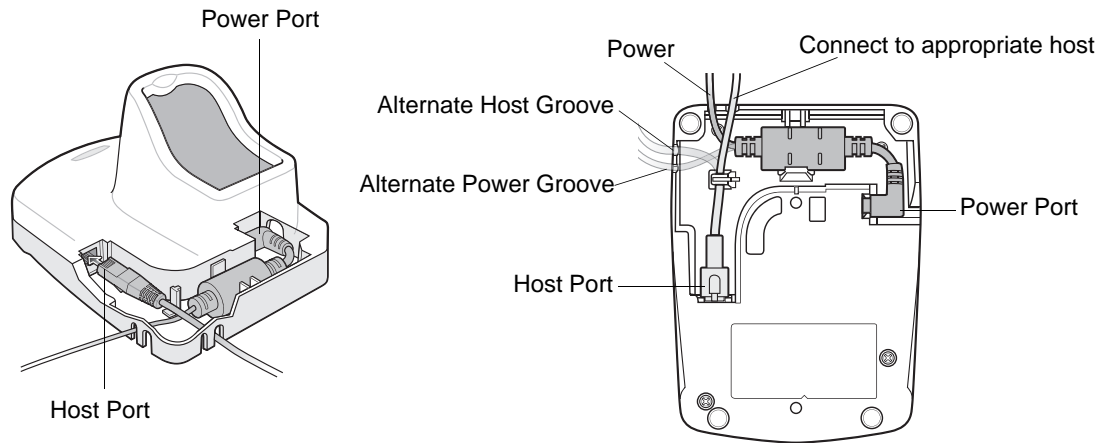

Figure 1-8 Connecting the Cables to the CR0078-P Cradle

Supplying Power to the CR0078-P Cradle

The CR0078-P cradle receives power from an external power supply.

- ✓ **NOTE** The CR0078-S cradle has the ability to be powered by the USB port instead of an external power supply. The CR0078-P can only receive power via an external power supply.

Lost Connection to Host

If scanned data does not transmit to the cradle's host, ensure that all cables are firmly inserted and the power supply is connected to an appropriate AC outlet. If scanned data still does not transmit to the host, reestablish a connection with the host:

- Disconnect the power supply from the cradle.
- Disconnect the host interface cable from the cradle.
- Wait three seconds.
- Reconnect the host interface cable to the cradle.
- Reconnect the power supply to the cradle, if required.
- Reestablish pairing with the cradle by scanning the pairing bar code.

- ✓ **NOTE** The CR0078-S does not always require a power supply whereas, the CR0008-S and CR0078-P always require a power supply.

Mounting the Cradle

For information on mounting the CR0078-S cradle, refer to the *CR0078-S/CR0008-S Cradle Quick Reference Guide*.

Replacing the Digital Scanner Battery

The battery is installed in the cordless digital scanner by the factory and resides in a chamber in the digital scanner handle. To replace the battery:

1. Insert a Phillips screwdriver in the screw at the base of the digital scanner, then turn the screw counterclockwise to release the latch.
2. Remove the latch.
3. If a battery is already installed, turn the digital scanner upright to slide the battery out. Disconnect the battery connector clip.

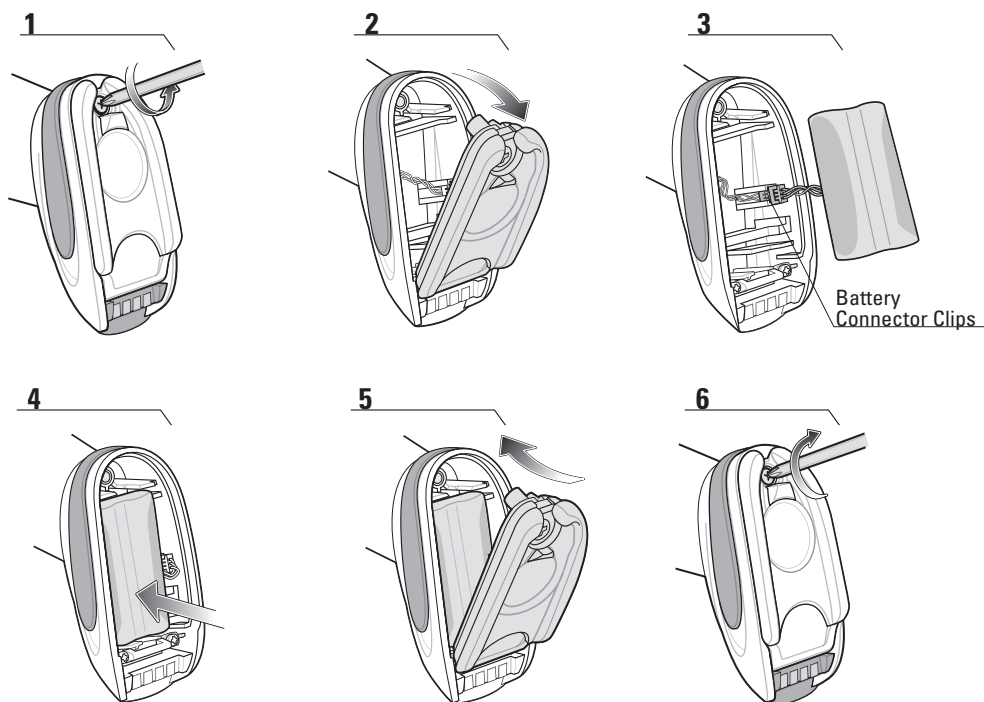

Figure 1-9 *Inserting the Battery*

4. With the contacts on the connector clips facing in the same direction, attach the new battery's connector clip to the connector clip in the base of the digital scanner.
5. Slide the new battery into the battery well and ensure the battery leads are visible. The battery should sit securely in the well.
6. Attach and close the latch.
7. Insert a Phillips screwdriver in the screw at the base of the digital scanner, press down gently, and turn the screw clockwise to lock the latch in place.

Inserting the Digital Scanner in the Cradle

Insert the digital scanner in the cradle so that the metal contacts on the bottom of the digital scanner handle touch the contacts on the cradle. Push the handle lightly to ensure a proper connection, engaging the contacts in the cradle and digital scanner. Ensure the desk/wall mount converter knob on the back of the cradle is in the correct position for the horizontal or vertical mounting.

- ✓ **NOTE** References to mounting the cradle only apply to the CR0078-S/CR0008-S cradle (not the CR0078-P cradle).

Inserting Digital Scanner in the CR0078-S/CR0008-S Cradle

Horizontal Cradle Mount

When mounting the cradle horizontally, where no fastening is necessary:

1. Ensure the rubber feet are attached to the cradle. These feet provide traction and prevent surface damage.
2. Ensure the desk/wall mount converter knob is in the position shown in [Figure 1-10](#).

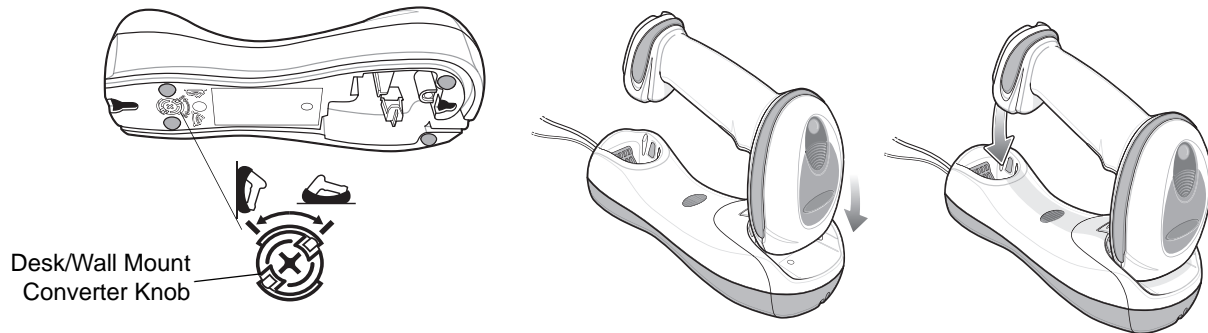

Figure 1-10 Horizontal Mount - Inserting the Digital Scanner in the Cradle

Vertical Cradle Mount

When mounting the cradle vertically:

1. Ensure the rubber feet are attached to the cradle. These feet provide traction and prevent surface damage.
2. Ensure the convertible mount hook on the front of the cradle is inserted with the hook facing up. If not, remove and reverse the hook so that it is in position to secure the digital scanner in place. (See [Figure 1-3 on page 1-4](#) for the location of the convertible mount hook.)

3. Ensure the desk/wall mount converter knob is in the position shown in *Figure 1-11*.

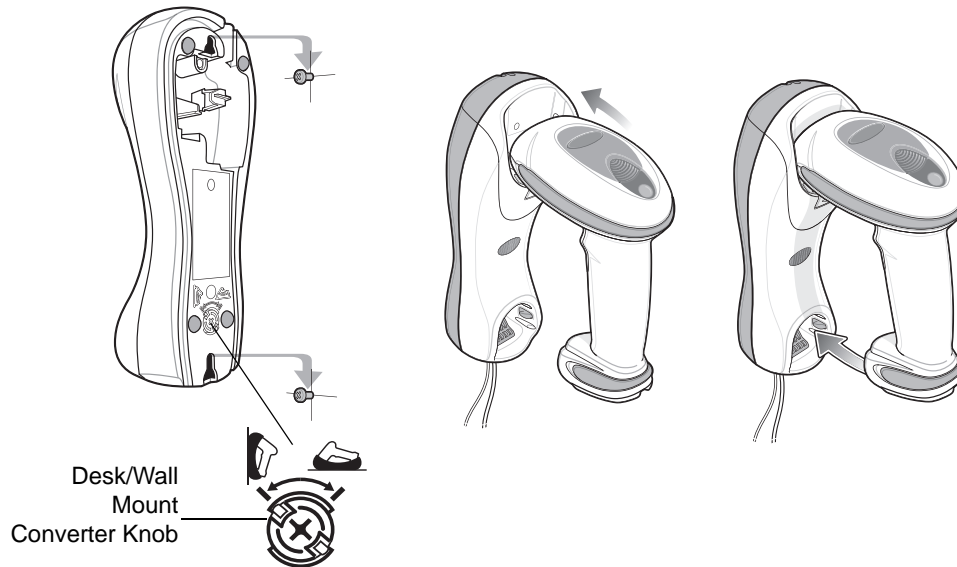

Figure 1-11 Vertical Mount - Inserting the Digital Scanner in the Cradle

Inserting/Removing Digital Scanner in the CR0078-P Cradle

To insert the scanner in the cradle:

1. Insert the scanner by placing the bottom of the scanner, at a slight forward angle, into the CR0078-P cradle.
2. Push the handle back and down until it clicks, engaging the contacts of the scanner and cradle.

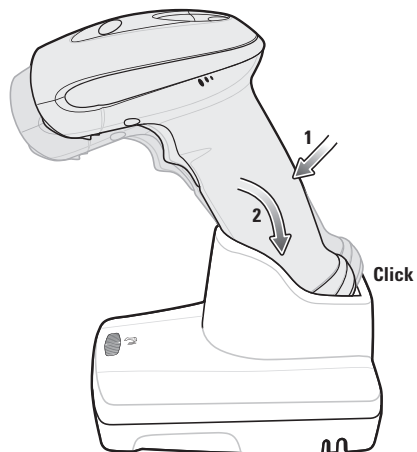

Figure 1-12 Inserting the Digital Scanner in the Cradle

To remove the scanner from the cradle:

1. Remove the scanner by pushing the scanner slightly forward and up out of the CR0078-P cradle.

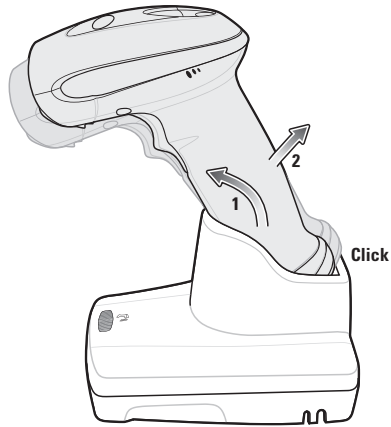

Figure 1-13 *Removing the Digital Scanner in the Cradle*

Charging the Digital Scanner Battery

Fully charge the digital scanner battery before using the digital scanner for the first time. To charge the digital scanner battery, place the digital scanner in the cradle, ensuring that the metal contacts on the bottom of the digital scanner touch the contacts on the cradle. The battery begins charging when the digital scanner LED indicator starts flashing green for the CR0078-S cradle and turns solid green for the CR0078-P cradle. A complete charge of a fully discharged battery can take up to three hours using external power and up to five hours using non-external cable power.



CAUTION To avoid a battery temperature fault, always charge the battery in the digital scanner within the recommended temperature of 32° to 104° F (0° to 40° C) nominal, 41° to 95° F (5° to 35° C) ideal.

Charging LED

When powered up, the cradle LED is always green. The digital scanner LED flashes green during charging. See [Table 2-2 on page 2-3](#) for all charging LED indications.

Shutting Off the Digital Scanner Battery

To shut off the NiMH battery for long term storage or shipping:

1. Scan **Battery Off** below.

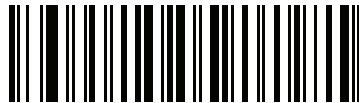

Battery Off

2. To turn the battery back on, place the digital scanner in the cradle.



NOTE Always scan the **Battery Off** bar code in handheld mode.

Reconditioning the Digital Scanner Battery

To maintain optimal performance of the digital scanner NiMH battery, perform a battery recondition approximately once a year.

To begin the battery recondition cycle:

1. Scan **Battery Recondition** below.



Battery Recondition

2. Place the digital scanner into the cradle.

✓ **NOTE** If the scanner is removed from the cradle during the battery reconditioning cycle, the scanner exits the battery reconditioning mode of operation and returns to the normal mode of battery charging (see [Charging the Digital Scanner Battery on page 1-15](#)). To restart the battery reconditioning cycle, re-scan the **Battery Recondition** parameter and place the scanner in the cradle.

3. The digital scanner must perform two charge cycles to complete the battery reconditioning process (discharge/charge/discharge/charge). See [Table 1-2](#).

Battery Reconditioning LED Definitions

Table 1-2 *Battery Reconditioning LED Definitions*

Battery Reconditioning Mode	LED	Comments
Discharging	Red Flash	Time to discharge is approximately 2.5 hours.
Charging	Green Flash	Time to charge is approximately 2.5 hours with an external power supply.
Reconditioning Complete	Green - Solid (always on)	The digital scanner enters a trickle charge until the digital scanner is removed from the cradle.

Radio Communications

The digital scanner can communicate with remote devices via Bluetooth Technology Profile Support, or by pairing with a cradle. For radio communication parameters, detailed information about operational modes, Bluetooth Technology Profile Support and pairing, see [Chapter 4, Radio Communications](#).

Configuring the Digital Scanner

Use the bar codes in this manual or the 123Scan² configuration program to configure the digital scanner. See [Chapter 5, User Preferences & Miscellaneous Digital Scanner Options](#) and [Chapter 6, Imaging Preferences](#) for information about programming the digital scanner using bar code menus. Also see each host-specific chapter to set up connection to a specific host type. See [Chapter 13, 123Scan2](#) to configure the digital scanner using this configuration program.

Accessories

The digital scanner and cradle accessories that are available separately include:

- Power supplies for applications that do not supply power over the host cable. See each host interface chapter for set up information.
- Wall-mount bracket for mounting the cradle vertically. Refer to the *CR0078-S/CR0008-S Cradle Quick Reference Guide* (p/n 72-135874-xx) for a wall mounting template and installation instructions.
- Lanyard for wearing the digital scanner on a wrist.

Lanyard

The lanyard attaches to the inside of the digital scanner battery door latch.

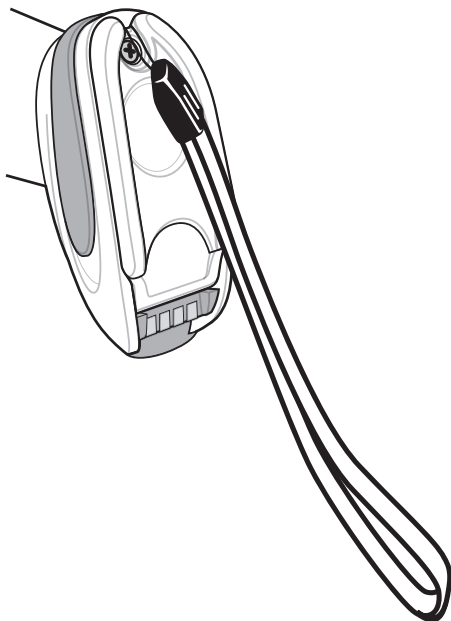

Figure 1-14 Attached Lanyard

To attach the lanyard:

1. Open the battery door latch as described in [Replacing the Digital Scanner Battery on page 1-11](#). Do not remove the battery.
2. Hook the loop of the lanyard around the screw container inside the battery door latch, between the loop guides.

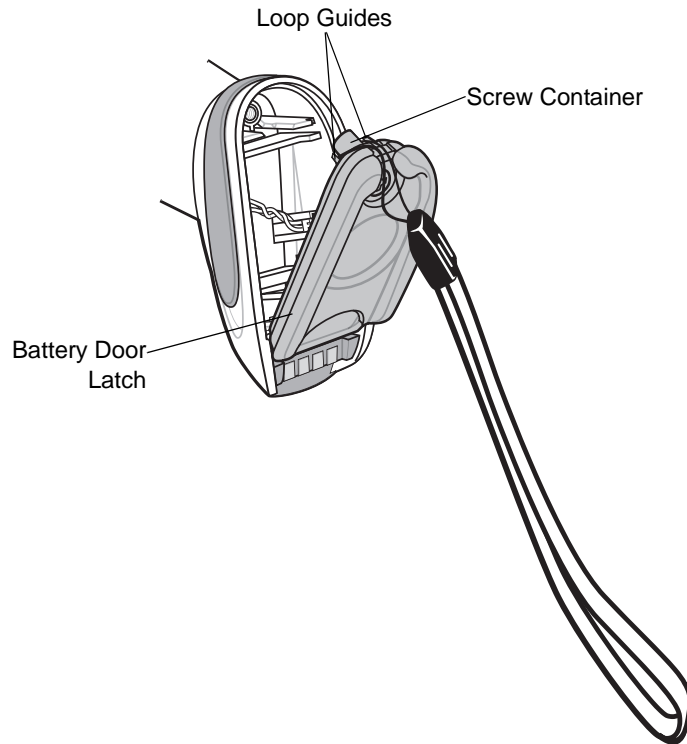

Figure 1-15 *Attaching Lanyard*

3. Close the battery door latch.
4. Tighten the screw.

CHAPTER 2 SCANNING

Introduction

This chapter provides beeper and LED definitions, scanning techniques, general instructions and tips about scanning, and decode ranges.

Beeper Definitions

The digital scanner issues different beep sequences and patterns to indicate status. [Table 2-1](#) defines beep sequences that occur during both normal scanning and while programming the digital scanner. (For additional beeper definitions, see [Wireless Beeper Definitions on page 4-3](#).)

Table 2-1 Standard Beeper Definitions

Beeper Sequence	Indication
Standard Use	
Low/medium/high beeps	Power up.
High beep	A bar code symbol was decoded (if decode beeper is enabled).
Four long low beeps	<ol style="list-style-type: none">1. A transmission error was detected in a scanned symbol. The data is ignored. This occurs if a unit is not properly configured. Check option setting.2. When communicating with a cradle, the cradle acknowledges receipt of data. If the acknowledgment is not received, this transmission error beep sequence sounds. Data may still have been received by the host. Check the host system for receipt of transmitted data. If data was not received by the host, re-scan the bar code.
Four short beeps	Low battery warning.
Five low long beeps	Conversion or format error.

Table 2-1 Standard Beeper Definitions (Continued)

Beeper Sequence	Indication
Low beep	Digital scanner detects power when inserted into a cradle. Note: This feature is enabled by default and can be disabled (see Beep on Insertion on page 5-10).
Low/high/low/high beeps	Out of memory - unable to store a new bar code.
Low/high/low beeps	ADF transmit error.
High/high/high/low beeps	RS-232 receive error.
Parameter Menu Scanning	
Long low/long high beeps	Input error, incorrect bar code or Cancel scanned, wrong entry, incorrect bar code programming sequence; remain in program mode.
High/low beeps	Keyboard parameter selected. Enter value using bar code keypad.
High/low/high/low beeps	Successful program exit with change in the parameter setting.
Long low/long high/long low/long high beeps	Out of host parameter storage space. Scan Default Parameters on page 5-5 .
Image Capture	
Low beep	Snapshot mode started or completed.
High/low beeps	Snapshot mode timed out.
Wireless Operation	
High/low/high/low beeps	Pairing bar code scanned.
Low/high beeps	Bluetooth connection established.
High/low beeps	Bluetooth disconnection event. Note: When connected to a remote device using SPP or HID, if a disconnect beep sequence sounds immediately after a bar code is scanned, check the host device for receipt of transmitted data. It is possible that an attempt was made to transmit the last bar code scanned after the connection was lost.
Long low/long high beeps	Page timeout; remote device is out of range/not powered.
Long low/long high/long low/long high beeps	Connection attempt was rejected by remote device.
Code 39 Buffering	
High/low beeps	New Code 39 data was entered into the buffer.
Three long high beeps	Code 39 buffer is full.
High/low/high beeps	The Code 39 buffer was erased.
Low/high/low beeps	The Code 39 buffer was erased or there was an attempt to clear or transmit an empty buffer.
Low/high beeps	A successful transmission of buffered data.

Table 2-1 Standard Beeper Definitions (Continued)

Beeper Sequence	Indication
Host Specific	
USB only	
Four high beeps	Digital scanner has not completed initialization. Wait several seconds and scan again.
Digital scanner gives a power-up beep after scanning a USB Device Type.	Communication with the bus must be established before the digital scanner can operate at the highest power level.
This power-up beep occurs more than once.	The USB bus may put the digital scanner in a state where power to the digital scanner is cycled on and off more than once. This is normal and usually happens when the host PC cold boots.
RS-232 only	
High beep	A <BEL> character is received and Beep on <BEL> is enabled (Point-to-Point mode only).

LED Definitions

In addition to beeper sequences, the digital scanner communicates with the user using a two-color LED display. [Table 2-2](#) defines LED colors that display during scanning.

Table 2-2 Scanner LED Definitions with CR0078-S Cradle

LED	Indication
Scanning	
Green Flash	A bar code was successfully decoded.
Red Solid	Transmission error or digital scanner malfunction.
Charging	
Green - Slow Continuous Flash	Non-critical battery temperature fault. Battery is above or below normal operating temperature. If this occurs, do not use the digital scanner and move the digital scanner to a location within normal operating temperature. The digital scanner can remain in the cradle while the battery warms or cools to normal operating temperature. Note: For appropriate charging temperatures, see Table 3-3 on page 3-10 .
Green - Fast Continuous Flash	Digital scanner is charging.
Green Solid	Digital scanner is fully charged.
Red Solid	Scanner is in pre-charge, charge error or communications error with cradle.
Amber Flash	Critical battery temperature fault. Battery is above or below normal operating temperature. If this occurs, do not use the digital scanner and move the digital scanner to a location within normal operating temperature. The digital scanner can remain in the cradle while the battery warms or cools to normal operating temperature. Note: For appropriate charging temperatures, see Table 3-3 on page 3-10 .

- ✓ **NOTE** If the scanner was previously unpowered and the LED indicator light is solid red, the scanner is in pre-charge mode. It is normal for pre-charge mode to last several seconds while the scanner powers up, however it can last several minutes if the battery has significantly discharged due to excessive use or storage. If the solid red LED condition persists, there may be a problem with the battery or the scanner, in which case discontinue use of the scanner and contact support.

Table 2-3 Scanner LED Definitions with CR0078-P Cradle

LED	Indication
Green Solid	Blinks off for a decode then turns solid green until the next decode.
Red Solid	Communication error with cradle.

Table 2-4 CR0078-S/CR0008-S Cradle LED Definitions

LED	Indication
Green Solid	Cradle is powered.
Green Flash	Cradle is externally powered with a USB host interface that suspended the cradle. The cradle is no longer connected to the digital scanner but charges the digital scanner. Scan the pairing bar code to pair the scanner and cradle (see Pairing on page 4-22).
Red Flash	Transmission error.

Table 2-5 CR0078-P Cradle LED Definitions

LED	Indication
Green Solid	Cradle is powered (scanner not in cradle). Fully charged scanner (scanner in cradle).
Green Flash	Charging scanner (scanner in cradle).
Red Flash	Transmission error.
Red Solid	Charge error (scanner in cradle).
Blue Solid	When Page Button is enabled and pressed (see Page Button on page 4-28), the cradle LED turns blue when the scanner is out of the cradle.
Amber Flash	Critical battery temperature fault. Battery is above or below normal operating temperature. If this occurs, do not use the digital scanner and move the digital scanner to a location within normal operating temperature. The digital scanner can remain in the cradle while the battery warms or cools to normal operating temperature. Note: For appropriate charging temperatures, see Table 3-3 on page 3-10 .

Scanning

To program the digital scanner, see the appropriate host chapter, [Chapter 4, Radio Communications](#) and [Chapter 15, Symbologies](#). (In addition to the parameters included in these chapters, user preferences and miscellaneous digital scanner options are also available in this guide.)

Hand-held Scanning

To scan:

1. Ensure all connections are secure (see appropriate host chapter).
2. Aim the digital scanner at the bar code.
3. Press the trigger.

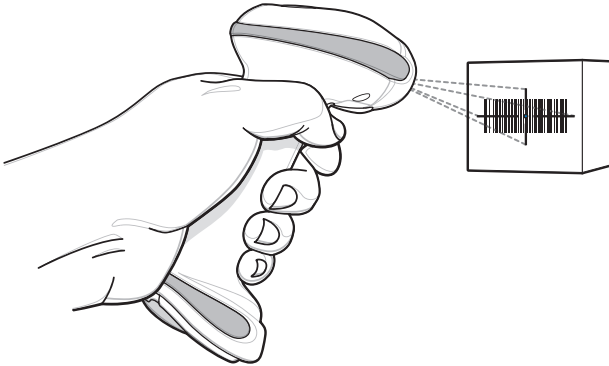

Figure 2-1 Scanning

4. Upon successful decode, the digital scanner beeps and the LED flashes green. (For more information about beeper and LED definitions, see [Table 2-1](#) and [Table 2-2](#).)

Hands-free Scanning

The digital scanner is in hands-free (presentation) mode when it sits in the CR0078-P cradle. In this mode the digital scanner operates in continuous (constant-on) mode, where it automatically decodes a bar code presented in the field of view.

To scan:

1. Ensure all connections are secure (see appropriate host chapter).
2. Present the bar code in the digital scanner field of view.

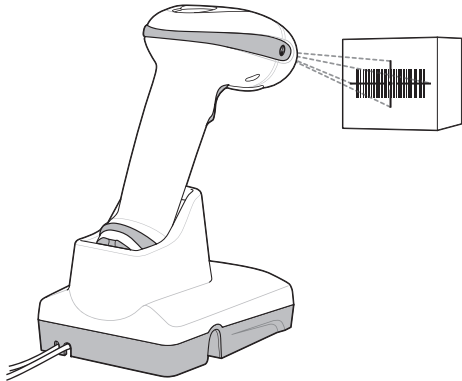

Figure 2-2 Scanning

3. Upon successful decode, the digital scanner beeps and the LED flashes green. (For more information about beeper and LED definitions, see [Table 2-1](#) and [Table 2-2](#).)

Aiming

When scanning, the digital scanner projects a red laser aiming pattern which allows positioning the bar code within its field of view. See [Decode Ranges on page 2-8](#) for the proper distance to achieve between the digital scanner and a bar code.

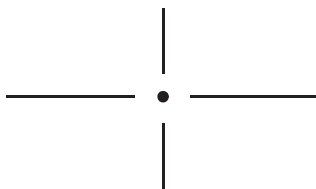

Figure 2-3 Imager Aiming Pattern

To scan a bar code, center the symbol in any orientation within the aiming pattern. Ensure the entire symbol is within the rectangular area formed by the cross pattern.

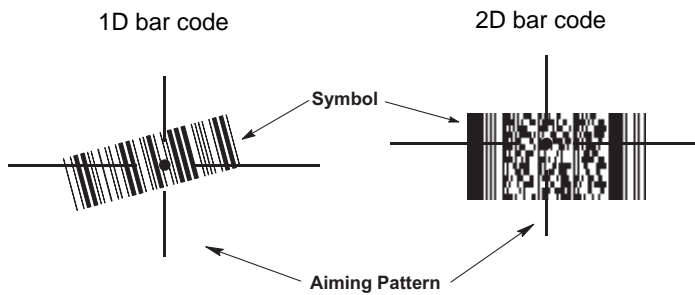

Figure 2-4 Scanning Orientation with Imager Aiming Pattern

The digital scanner can also read a bar code presented within the aiming pattern but not centered. The top examples in [Figure 2-5](#) show acceptable aiming options, while the bottom examples can not be decoded.

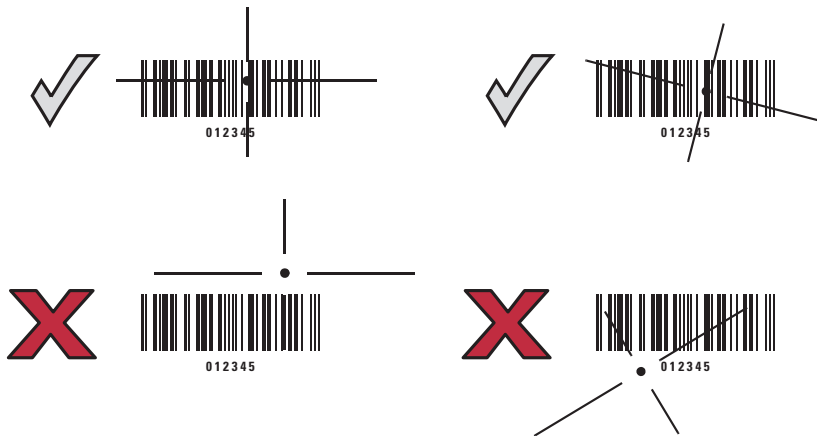

Figure 2-5 Acceptable and Incorrect Aiming

Decode Ranges

Table 2-6 DS6878-SR / DS6878-HC / DS6878-DL Decode Ranges

Symbol Density	Bar Code Type	Typical Working Ranges	
		Near	Far
5 mil	Code 39	0.7	6.6
13 mil	100% UPC	1.2	14.2
5 mil	PDF	2.0	4.5
6.6 mil	PDF	1.2	6.0
10 mil	Data Matrix	1.1	7.2

Table 2-7 DS6878-HD Decode Ranges

Symbol Density	Bar Code Type	Typical Working Ranges	
		Near	Far
3 mil	Code 39	0.6	3.4
5 mil	Code 39	FOV ^a	4.9
13 mil	100% UPC	1.2	6.8
4 mil	PDF	0.9	2.8
10 mil	Data Matrix	0.6	4.2

a.Field of View

CHAPTER 3 MAINTENANCE, TROUBLE-SHOOTING & TECHNICAL SPECIFICATIONS

Introduction

This chapter provides suggested digital scanner and cradle maintenance, troubleshooting, technical specifications, and signal descriptions (pinouts).

Maintenance

Digital Scanner

Cleaning the exit window is required. A dirty window may affect scanning accuracy.

- Do not allow any abrasive material to touch the window.
- Remove any dirt particles with a damp cloth.
- Wipe the scanner window using a tissue moistened with an approved cleanser (listed below)
- Do not spray water or other cleaning liquids directly into the window.

The DS6878-HC design allows safe cleansing of the product plastics with a variety of cleaning products and disinfectants. If required, wipe the digital scanner with the following list of approved cleansers:

- Isopropyl alcohol
- Bleach/sodium hypochlorite
- Hydrogen peroxide
- Gentle dish soap and water



IMPORTANT Cleansers that contain active ingredients not listed above should not be utilized on the DS6878-HC digital scanner.

Digital Scanner Cradle

Do not pour, spray, or spill any liquid on the cradle. Wipe the cradle using the same approved cleansers as the Digital Scanner.



CAUTION Avoid using cleansers directly on the digital scanner battery door, contacts and cradle contacts. Use a cotton swab moistened with alcohol to gently clean contacts.

Known Harmful Ingredients

The following chemicals are known to damage the plastics on Zebra scanners/cradles and should not come in contact with the device:

- Ammonia solutions
- Compounds of amines or ammonia
- Acetone
- Ketones
- Ethers
- Aromatic and chlorinated hydrocarbons
- Aqueous or alcoholic alkaline solutions
- Ethanolamine
- Toluene
- Trichloroethylene
- Benzene
- Carboic acid
- TB-lysoform



IMPORTANT Some hand sanitizers commonly used in the healthcare environment may contain the harmful ingredients listed above, such as ethanolamine. Hands must be completely dry before handling the DS6878-HC digital scanner to prevent inadvertent contamination with known harmful ingredients and damage to the plastics.

Daily Cleaning and Disinfecting

Following are the cleaning and disinfecting instructions for environments that require daily or more frequent cleaning to prevent the spread of germs, including healthcare workers who need to disinfect their scanner after each patient visit and retail and other shift workers who share devices.

1. Dampen a soft cloth with one of the approved cleaning agents listed above or use pre-moistened wipes.
2. Gently wipe all surfaces, including the front, back, sides, top and bottom. Never apply liquid directly to the scanner. Be careful not to let liquid pool around the scanner window, trigger, cable connector or any other area on the device.
3. Be sure to clean the trigger and in between the trigger and the housing (use a cotton-tipped applicator to reach tight or inaccessible areas).
4. Immediately dry the scanner window after cleaning with a soft non-abrasive cloth to prevent streaking.
5. Allow the unit to air dry before use.

Monthly 'Deep Cleaning' Maintenance

Keep your scanner and cradle in good working order with a regular comprehensive cleaning routine to remove the natural build-up of dirt that occurs with everyday use on connectors and the scanner exit window as well as, the main surfaces of the device.

1. Housing: Follow the instructions for daily cleaning and disinfecting above to give the housing a general cleaning.
2. Scanner exit window: Wipe the scanner exit window with a lens tissue or other material suitable for cleaning optical material such as eyeglasses.
3. Scanner connector:
 - a. Dip the cotton portion of a cotton-tipped applicator in isopropyl alcohol.
 - b. Rub the cotton portion of the cotton-tipped applicator back-and-forth across the connector on the scanner. Do not leave any cotton residue on the connector.
 - c. Repeat at least 3 times.
 - d. Use the cotton-tipped applicator dipped in alcohol to remove any grease and dirt near the connector area.
 - e. Use a dry cotton tipped applicator and repeat steps c, d and e (do not apply alcohol as directed in any of these steps).
4. Cradle connector:
 - a. Remove the DC power cable from the cradle.
 - b. Dip the cotton portion of a cotton-tipped applicator in isopropyl alcohol.
 - c. Rub the cotton portion of the cotton-tipped applicator along the pins of the connector. Slowly move the applicator back-and-forth from one side of the connector to the other. Do not let any cotton residue remain on the connector.
 - d. Rub all sides of the connector with the cotton-tipped applicator.
 - e. Spray compressed air in the connector area by pointing the tube/nozzle approximately 1/2 inch (1 cm) away from the surface.



CAUTION When using compressed air, always wear eye protection; do not point nozzle at yourself or others; make sure the nozzle or tube is pointing away from your face; read warning label on compressed air product.

- f. Ensure that there is no lint left by the cotton tipped applicator. Remove lint if found.
- g. If grease and other dirt are found on other areas of the cradle, use a lint free cloth and isopropyl alcohol to remove.
- h. Allow at least 10 to 30 minutes (depending on ambient temperature and humidity) for the isopropyl alcohol to air dry before applying power to cradle.



NOTE If the temperature is low and humidity is high, longer drying time is required. Warm temperature and dry humidity requires less drying time.

Battery Information

Rechargeable battery packs are designed and constructed to the highest standards within the industry. However, there are limitations to how long a battery can operate or be stored before needing replacement. Many factors affect the life of a battery pack such as heat, cold, customer usage profiles, age and severe drops.

When batteries are stored over a year, battery cell manufacturers advise that some irreversible deterioration in overall battery quality may occur. To minimize this loss, they recommend storing batteries half charged in a dry, cool place between 41° F and 77° F (5° C and 25° C), the cooler the better, and removed from the equipment to prevent the loss of capacity. Batteries should be charged to half capacity at least once a year. If an electrolyte leakage is observed, avoid any contact with the affected area and properly dispose of the battery.

Replace the battery when a significant loss of run time is detected. Batteries must be charged within the 32° F to 104° F (0° C to 40°C) temperature range.

The standard warranty period for all Zebra batteries is 30 days, regardless if the battery was purchased separately or included as part of the digital scanner.

Troubleshooting

Table 3-1 *Troubleshooting*

Problem	Possible Causes	Possible Solutions
Battery		
Digital Scanner battery requires frequent charging.	Battery may need reconditioning.	Restore the battery by performing a battery reconditioning cycle. See Reconditioning the Digital Scanner Battery on page 1-16 for more information.
Digital Scanner displays solid red LED longer than 3 seconds when placed in cradle.	Battery may require pre-charge due to excessive discharge.	Wait for the red LED to turn green indicating that the scanner has begun normal charging. Recommend allowing battery to fully recharge.
Beeper Indications		
Digital Scanner emits low/high/low beeps.	ADF transmit error.	See Chapter 16, Advanced Data Formatting for information about ADF programming.
	Invalid ADF rule is detected.	See Chapter 16, Advanced Data Formatting for information about ADF programming.
	The Code 39 buffer was erased or there was an attempt to clear or transmit an empty buffer.	Normal when scanning the Code 39 Buffering Clear Buffer bar code or upon attempt to transmit an empty Code 39 buffer.

Table 3-1 Troubleshooting (Continued)

Problem	Possible Causes	Possible Solutions
Digital Scanner emits a low/high/low/high beep sequence while it is being programmed.	Out of ADF parameter storage space.	Erase all rules and re-program with shorter rules.
Digital Scanner emits long low/long high beeps.	Input error, incorrect bar code or Cancel bar code was scanned.	Scan the correct numeric bar codes within range for the parameter programmed.
	Page timeout; remote device is out of range/not powered.	Move the digital scanner back into range of the remote device; try to re-connect; check remote device configuration.
Digital Scanner emits long low/long high/long low/long high beeps.	Out of host parameter storage space.	Scan <i>Default Parameters on page 5-5</i> .
	Out of memory for ADF rules.	Reduce the number of ADF rules or the number of steps in the ADF rules.
	Connection attempt was rejected by remote device.	Free up remote device resources.
Digital Scanner emits high/high/high/low beeps.	RS-232 receive error.	Normal during host reset. Otherwise, set the digital scanner's RS-232 parity to match the host setting.
Digital Scanner emits high/low beeps.	The digital scanner is buffering Code 39 data. Or Keyboard parameter selected.	Normal. Or Enter value using bar code keypad.
	Bluetooth disconnection event.	Move the digital scanner back into range of the remote device. In Master (SPP) mode, re-pair the digital scanner and cradle by scanning the PAIR bar code on the cradle; check cradle power. In Slave (SPP/HID) mode, reestablish connection between the digital scanner and remote device from the remote device side.
Digital Scanner emits three long high beeps.	Code 39 buffer is full.	Scan the Code 39 bar code without a leading space or scan Do Not Buffer Code 39 on <i>Code 39 Buffering - Scan & Store on page 15-32</i> to transmit stored Code 29 data.
Digital Scanner emits four high beeps on trigger release.	Low battery.	Place digital scanner in cradle to charge the battery.

Table 3-1 Troubleshooting (Continued)

Problem	Possible Causes	Possible Solutions
Digital Scanner emits four long low beeps.	A transmission error was detected in a scanned symbol. The data is ignored.	This occurs if a unit is not properly configured. Check option setting.
	The digital scanner is either: - Out of range - Not paired to the cradle - Not connected to a remote Bluetooth device.	Move the digital scanner back into range of the remote device. Or Scan the PAIR bar code on the cradle.
	Acknowledgment that transmitted data was not received by the cradle.	Data may have been received by the host. Check the host system for receipt of transmitted data. If data was not received by the host, re-scan the bar code.
Digital Scanner emits five low long beeps.	Conversion or format error.	Check ADF rules for the host.
Decoding Bar Codes		
Digital Scanner emits the laser, but does not decode the bar code.	Digital Scanner is not programmed for the correct bar code type.	Program the digital scanner to read that type of bar code. See Chapter 15, Symbologies .
	Bar code symbol is unreadable.	Scan test symbols of the same bar code type to determine if the bar code is defaced.
	Distance between digital scanner and bar code is incorrect.	Move the digital scanner closer to or further from the bar code. See Decode Ranges on page 2-8 .
	The scan line is not crossing every bar and space of the symbol.	Move the symbol until the scan line is within the acceptable aiming pattern. See Figure 2-1 on page 2-5 .
Digital Scanner decodes bar code, but does not transmit the data to the host.	Digital Scanner is not programmed for the correct host type.	Scan the appropriate host type programming bar code. See the chapter corresponding to the host type.
	Interface cable is loose.	Ensure all cable connections are secure.
	Cradle is not programmed for the correct host interface.	Check digital scanner host parameters or edit options.
	Digital Scanner not paired to host-connected interface.	Pair the digital scanner to the cradle by scanning the PAIR bar code on the cradle.

Table 3-1 Troubleshooting (Continued)

Problem	Possible Causes	Possible Solutions
	Cradle has lost connection to host.	<i>In this exact order:</i> disconnect power supply; disconnect host cable; wait three seconds; reconnect host cable; reconnect power supply; reestablish pairing.
Digital Scanner emits five long low beep after a bar code is decoded.	Conversion or format error was detected. The digital scanner's conversion parameters are not properly configured.	Ensure the digital scanner's conversion parameters are properly configured.
	Conversion or format error was detected. An ADF rule was set up with characters that can't be sent for the host selected.	Change the ADF rule, or change to a host that can support the ADF rule.
	Conversion or format error was detected. A bar code was scanned with characters that can't be sent for that host.	Change the bar code, or change to a host that can support the bar code.
Host Displays		
Host displays scanned data incorrectly.	Digital Scanner is not programmed to work with the host.	Ensure the proper host is selected. Scan the appropriate host type programming bar code.
		For RS-232, ensure the digital scanner's communication parameters match the host's settings.
		For a USB Keyboard (HID) or Keyboard Wedge configuration, ensure the system is programmed for the correct keyboard type and language, and turn off the CAPS LOCK key.
		Ensure editing options (e.g., ADF, UPC-E to UPC-A Conversion) are properly programmed.
		Check the digital scanner's host type parameters or editing options.

Table 3-1 *Troubleshooting (Continued)*

Problem	Possible Causes	Possible Solutions
Trigger		
Nothing happens when the trigger is pulled.	No power to the digital scanner.	Check the system power. If the configuration requires a power supply, re-connect the power supply. Check the battery. Ensure that end cap to battery chamber is secured.
	Interface/power cables are loose.	Check for loose cable connections and re-connect cables.
	Digital Scanner is disabled.	For Synapse or IBM-468x mode, enable the digital scanner via the host interface.
The laser aiming or illumination does not appear when the trigger is pulled.	No power to the digital scanner.	Check battery and charging contacts; ensure that end cap to battery chamber is secured; ensure all power and cable connections to cradle are secure.
	Interface/power cables are loose.	Check battery and charging contacts; ensure power and cable connections to cradle are secure.



NOTE If after performing these checks the symbol still does not scan, contact the distributor or contact Support. See [page xxiv](#) for contact information.

Technical Specifications

Table 3-2 *Technical Specifications - DS6878 Digital Scanner*

Item	Description
Physical Characteristics	
Dimensions	7.3 in. H x 3.85 in. L x 2.7 in. W (18.5 cm H x 9.7 cm L x 6.9 cm W)
Weight (with battery)	Approximately 8.4 oz. (238 g)
Color	Cash Register White or Twilight Black HC Configuration: Healthcare White
Performance Characteristics	
Light Source:	Aiming Pattern: 650 nm laser diode Illumination: 630 nm LED
Frame Rate	Decode Mode: Up to 60 fps
Radio Range	Minimum 33 ft (10m) / Typical warehouse environment 50 ft. (15m)
Battery Specifications	750mAH NiMH - (3) AAA number of scans per full charge: typically 15,000 @ 1 scan/second Charge Time: Fully discharged battery: < 3 hours via external power / approximately 5.5 hours via host power through cable
Roll Tolerance	± 360°
Pitch Tolerance	± 60°
Yaw Tolerance	± 60°
Nominal Working Distance	(See Decode Ranges on page 2-8)
Decode Capability	UPC/EAN and with supplementals, Code 39, Code 39 Full ASCII, Trioptic Code 39, GS1 DataBar Variants, GS1-128, Code 128, Code 128 Full ASCII, Code 93, Codabar (NW1), Interleaved 2 of 5, Discrete 2 of 5 MSI, Codell, IATA, Bookland EAN, Code 32
Interfaces Supported	See Table 3-3 .
User Environment	
Operating Temperature	32° to 122° F (0° to 50° C)
Storage Temperature	-40° to 158° F (-40° to 70° C)
Charging Temperature	32° to 104° F (0° to 40° C) nominal, 41° to 95° F (5° to 35° C) ideal
Humidity	5% to 95%, non-condensing
Drop Specifications	Withstands multiple 6 ft./1.8 m drops to concrete at room temperature. Withstands multiple 5 ft./1.5m drops to concrete at 0° to 50° C.
# of Cradle Insertions	250,000+ insertions

Table 3-2 *Technical Specifications - DS6878 Digital Scanner (Continued)*

Item	Description
Ambient Light Immunity	Incandescent - 150 ft. candles (1,600 Lux) Sunlight - 8,000 ft. candles (86,000 Lux) Fluorescent - 150 ft. candles (1,600 Lux) Mercury Vapor - 150 ft. candles (1,600 Lux) Sodium Vapor - 150 ft. candles (1,600 Lux) Immune to normal or artificial light
Accessories	
Lanyard	Lanyard attaches to the battery door.

Table 3-3 *Technical Specifications - CR0078-S/CR0008 Cradle*

Item	Description
Physical Characteristics	
Dimensions:	2.0 in. H x 8.35 in. L x 3.4 in. W (5 cm H x 21.1 cm L x 8.6 cm W)
Weight	Approximately 6.4 oz. (183 gm)
Voltage & Current	Charging Cradle: VoltageCurrent 5 +/- 10% VDC 700mA (External power) 5 +/- 10% VDC 475 mA (Host power through cable) 12 +/- 10% VDC 300 mA (External power) 12 +/- 10% VDC 220 mA (Host power through cable) Non-charging Cradle: 5V @ 70mA or 12 V @ 50 mA
Color	Cash Register White or Twilight Black HC Configuration: Healthcare White
Power Requirements	4.75 - 14.0 VDC
Performance Characteristics	
Interfaces Supported (CR0078-S only)	Features on-board Multiple Interface with: RS-232C (Standard, Nixdorf, ICL, & Fujitsu); IBM 468x/469x; Keyboard Wedge; USB (Standard, IBM SurePOS, Macintosh); SSI; Laser/Wand Emulation; 123Scan ² ; Remote Digital Scanner Management. In addition, Synapse allows for connectivity to all of the above plus many non-standard interfaces.
User Environment	
Operating Temperature	32° to 122° F (0° to 50° C)
Storage Temperature	-40° to 158° F (-40° to 70° C)
Charging Temperature	32° to 104° F (0° to 40° C) nominal, 41° to 95° F (5° to 35° C) ideal
Humidity	5% to 95% (non-condensing)

Table 3-3 *Technical Specifications - CR0078-S/CR0008 Cradle (Continued)*

Item	Description
Accessories	
Mounting Options	Desktop, mount on a wall, computer work station or medical cart.
Power Supplies	Power supplies are available for applications that do not supply power over host cable.

Table 3-4 *Technical Specifications - CR0078-P Cradle*

Item	Description
Physical Characteristics	
Dimensions:	5.4 in. L x 4 in. W x 3.6 in. H
Weight	Approximately 7.9 oz.
Voltage & Current	Charging Cradle: VoltageCurrent 12 +/- VDC 60mA (no scanner) 12 +/- VDC 160mA (idle scanner) 12 +/- VDC 335 mA (charging scanner)
Color	Twilight Black Healthcare White
Power Requirements	12 +/-10% VDC
Performance Characteristics	
Interfaces Supported (CR0078-P only)	Features on-board Multiple Interface with: RS-232C (Standard, Nixdorf, ICL, & Fujitsu); IBM 468x/469x; Keyboard Wedge; USB (Standard, IBM SurePOS, Macintosh); SNAPI; 123Scan ² ; Remote Digital Scanner Management.
User Environment	
Operating Temperature	32° to 122° F (0° to 50° C)
Storage Temperature	-40° to 158° F (-40° to 70° C)
Charging Temperature	32° to 104° F (0° to 40° C) nominal, 41° to 95° F (5° to 35° C) ideal
Humidity	5% to 95% (non-condensing)
Accessories	
Power Supplies	Power supply is required.

Cradle Signal Descriptions

The signal descriptions in [Table 3-5](#) apply to the connector on the digital scanner and are for reference only.

Table 3-5 Cradle Signal Pin-outs

Pin	IBM	Synapse	RS-232	Keyboard Wedge	Wand	USB
1	Reserved	SynClock	Reserved	Reserved	Reserved	Jump to Pin 6
2	Power	Power	Power	Power	Power	Power
3	Ground	Ground	Ground	Ground	Ground	Ground
4	IBM_A(+)	Reserved	TxD	KeyClock	DBP	Reserved
5	Reserved	Reserved	RxD	TermData	CTS	D +
6	IBM_B(-)	SynData	RTS	KeyData	RTS	Jump to Pin 1
7	Reserved	Reserved	CTS	TermClock	Reserved	D -
8	Reserved	Reserved	Reserved	Reserved	Reserved	Reserved
9	N/A	N/A	N/A	N/A	N/A	N/A
10	N/A	N/A	N/A	N/A	N/A	N/A

[Figure 3-1](#) illustrates the positions of the cradle pins.

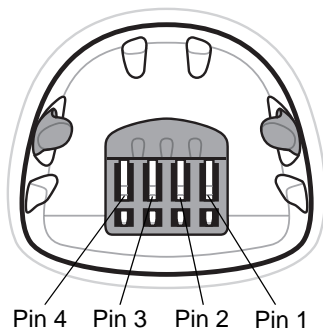

Figure 3-1 Cradle Pin Assignments

The signal descriptions in [Table 3-6](#) apply to the connector from the digital scanner to the digital scanner cradle and are for reference only.

Table 3-6 Cradle Pin-outs

Pin	Description
1	CRADLE_TXD
2	VCC
3	GND
4	CRADLE_RXD

CHAPTER 4 RADIO COMMUNICATIONS

Introduction

This chapter provides information about the modes of operation and features available for wireless communication between digital scanners, cradles and hosts. The chapter also includes the parameters necessary to configure the digital scanner.

The digital scanner ships with the settings shown in the [Radio Communication Default Parameters on page 4-2](#) (also see [Appendix A, Standard Default Parameters](#) for all host device and miscellaneous digital scanner defaults). If the default values suit requirements, programming is not necessary.

To set feature values, scan a single bar code or a short bar code sequence. The settings are stored in non-volatile memory and are preserved even when the digital scanner is powered down.

If not using a Synapse or USB cable with the cradle, select a host type (see each host chapter for specific host information) after the power-up beeps sound. This is only necessary upon the first power-up when connected to a new host.

To return all features to default values, scan a default bar code in [Default Parameters on page 5-5](#). Throughout the programming bar code menus, default values are indicated with asterisks (*).



* Indicates Default — ***Enable Pair on Contacts** — Feature/Option

Scanning Sequence Examples

In most cases, scan one bar code to set a specific parameter value.

Errors While Scanning

Unless otherwise specified, to correct an error during a scanning sequence, just re-scan the correct parameter.

Radio Communications Parameter Defaults

Table 4-1 lists the defaults for radio communication parameters. If you wish to change any option, scan the appropriate bar code(s) provided in the Radio Communications Parameters section beginning on [page 4-4](#).

✓ **NOTE** See [Appendix A, Standard Default Parameters](#) for all user preferences, hosts, symbologies, and miscellaneous default parameters.

Table 4-1 *Radio Communication Default Parameters*

Parameter	Default	Page Number
Bluetooth Host (Host Type)	Cradle Host	4-4
Discoverable Mode	General	4-7
Wi-Fi Friendly Mode	Disable	4-8
Wi-Fi Friendly Channel Exclusion	Use All Channels	4-8
Apple iOS HID Feature	Disable	4-10
Android HID Feature	Disable	4-10
Country Keyboard Types (Country Code)	North American	4-11
HID Keyboard Keystroke Delay	No Delay (0 msec)	4-13
CAPS Lock Override	Disable	4-13
Ignore Unknown Characters	Enable	4-14
Emulate Keypad	Disable	4-14
Keyboard FN1 Substitution	Disable	4-15
Function Key Mapping	Disable	4-15
Simulated Caps Lock	Disable	4-16
Convert Case	No Case Conversion	4-16
Beep on Reconnect Attempt	Disable	4-18
Reconnect Attempt Interval	30 sec	4-19
Auto-reconnect in Bluetooth Keyboard Emulation (HID Slave) Mode	On Bar Code Data	4-20
Modes of Operation (Point-to-Point/Multipoint-to-Point)	Point-to-Point	4-21
Parameter Broadcast (Cradle Host Only)	Enable	4-22
Pairing Modes	Unlocked	4-23
Pairing on Contacts	Enable	4-24
Connection Maintenance Interval	15 min	4-26
Authentication	Disable	4-29

Table 4-1 Radio Communication Default Parameters

Parameter	Default	Page Number
Variable Pin Code	Static	4-30
Encryption	Disable	4-31
Secure Simple Pairing IO Capability (SPP Server and SPP Master Host Mode Only)	No Input/No Output	4-32

Wireless Beeper Definitions

When the digital scanner scans the pairing bar code it issues various beep sequences indicating successful or unsuccessful operations. [Table 4-2](#) defines beep sequences that occur during pairing operations. (For additional beeper definitions, see [Beeper Definitions on page 2-1](#).)

Table 4-2 Wireless Beeper Definitions

Beeper Sequence	Indication
Four long low beeps	<ol style="list-style-type: none"> 1. A transmission error was detected in a scanned symbol. The data is ignored. This occurs if a unit is not properly configured. Check option setting. 2. When communicating with a cradle, the cradle acknowledges receipt of data. If the acknowledgment is not received, this transmission error beep sequence sounds. Data may still have been received by the host. Check the host system for receipt of transmitted data. If data was not received by the host, re-scan the bar code.
Five high beeps	Emitted every 5 seconds while a reconnection attempt is in progress. (See Auto-reconnect Feature on page 4-17 .)
High/low/high/low beeps	Pairing bar code scanned.
Low/high beeps	Bluetooth connection established.
High/low beeps	Bluetooth disconnection event. Note: When connected to a remote device using SPP or HID, if a disconnect beep sequence sounds immediately after a bar code is scanned, check the host device for receipt of transmitted data. It is possible that an attempt was made to transmit the last bar code scanned after the connection was lost.
Long low/long high beeps	Page timeout; remote device is out of range/not powered. (See Auto-reconnect Feature on page 4-17 .)
Long low/long high/long low/ long high beeps	Connection attempt was rejected by remote device. Note: In the case of Pairing Methods on page 4-24 , the cradle may already be connected to another digital scanner in single Point-to-Point locked mode, or the piconet may be full in Multipoint-to-Point mode. If Pair On Contacts is enabled and the digital scanner that is inserted is already connected to the cradle, no beeping occurs.

Radio Communications Host Types

To set up the digital scanner for communication with a cradle, or to use standard Bluetooth profiles, scan the appropriate host type bar code below.

- **Cradle Host (default)** - Select this host type for digital scanner(s) to cradle operation. The digital scanner must then be paired to the cradle and the cradle communicates directly to the host via the host interface cable connection.
- **Serial Port Profile (Master)** - Select this host type for Bluetooth Technology Profile Support (see [page 4-6](#)). The digital scanner connects to the PC/host via Bluetooth and performs like there's a serial connection. The digital scanner initiates the connection to the remote device and is the Master. Scan **Serial Port Profile (Master)**, then scan the **PAIR** bar code for the remote device. See [Pairing Bar Code Format on page 4-25](#) for information about creating a pairing bar code for a remote device.
- **Serial Port Profile (Slave)** - Select this host type for Bluetooth Technology Profile Support (see [page 4-6](#)). The digital scanner connects to the PC/host via Bluetooth and performs like there's a serial connection. The digital scanner accepts incoming connection requested from a remote device and is the Slave. Scan **Serial Port Profile (Slave)** and wait for the incoming connection.
- **Bluetooth Keyboard Emulation (HID Slave)** - Select this host type for Bluetooth Technology Profile Support. (See [page 4-6](#) for Bluetooth Technology Profile Support and Master/Slave definitions.) The digital scanner connects to the PC/host via Bluetooth and performs like a keyboard. The digital scanner accepts incoming connection requested from a remote device and is the slave. Scan **Bluetooth Keyboard Emulation (HID Slave)** and wait for the incoming connection.

- ✓ **NOTE**
1. The digital scanner supports keyboard emulation over the Bluetooth HID profile. For detailed information, and HID host parameters, see [HID Host Parameters on page 4-10](#).
 2. When the digital scanner is paired to the cradle in SPP Master or Cradle Host mode, the digital scanner automatically tries to reconnect to a remote device when a disconnection occurs that is due to the radio losing communication. For more information see [Auto-reconnect Feature on page 4-17](#).

Radio Communications Host Types (continued)



***Cradle Host**



Serial Port Profile (Master)



Serial Port Profile (Slave)



Bluetooth Keyboard Emulation (HID Slave)

Bluetooth Technology Profile Support

With Bluetooth Technology Profile Support, the cradle is not required for wireless communication. The digital scanner communicates directly to the host using Bluetooth technology. The digital scanner supports the standard Bluetooth Serial Port Profile (SPP) and HID Profiles which enable the digital scanner to communicate with other Bluetooth devices that support these profiles.

- SPP - the digital scanner connects to the PC/host via Bluetooth and performs like there's a serial connection.
- HID - the digital scanner connects to the PC/host via Bluetooth and performs like a keyboard.

Master/Slave Set Up

The digital scanner can be set up as a Master or Slave.

When the digital scanner is set up as a Slave, it is discoverable and connectable to other devices. When the digital scanner is set up as a Master, the Bluetooth address of the remote device to which a connection is requested is required. A pairing bar code with the remote device address must be created and scanned to attempt a connection to the remote device. See the [Pairing Bar Code Format on page 4-25](#) for information about creating a pairing bar code.

Master

When the digital scanner is set up as a Master (SPP), it initiates the radio connection to a slave device. Initiating the connection is done by scanning a pairing bar code for the remote device (see [Pairing Bar Code Format on page 4-25](#)).

Slave

When the digital scanner is set up as a Slave device (SPP), the digital scanner accepts an incoming connection request from a remote device.

✓ **NOTE** The number of digital scanners is dependent on the host's capability.

Bluetooth Friendly Name

You can set a meaningful name for the digital scanner that appears in the application during device discovery. The default name is the digital scanner name followed by its serial number, e.g., **DS6878 123456789ABCDEF**. Scanning **Set Defaults** reverts the digital scanner to this name; use custom defaults to maintain the user-programmed name through a **Set Defaults** operation.

To set a new Bluetooth Friendly Name, scan the following bar code, then scan up to 23 characters from [Appendix E, Alphanumeric Bar Codes](#). If the name contains less than 23 characters, scan [End of Message on page E-7](#) after entering the name.



NOTE If your application allows you to set a device name, this takes precedence over the Bluetooth Friendly Name.



Bluetooth Friendly Name

Discoverable Mode

Select a discoverable mode based on the device initiating discovery:

- Select **General Discoverable Mode** when initiating connection from a PC.
- Select **Limited Discoverable Mode** when initiating connection from a mobile device (e.g., Motorola Q), and the device does not appear in General Discoverable Mode. Note that it can take longer to discover the device in this mode.

The device remains in Limited Discoverable Mode for 30 seconds, and green LEDs flash while in this mode. It is then non-discoverable. To re-active Limited Discoverable Mode, press the trigger.



***General Discoverable Mode**



Limited Discoverable Mode

Wi-Fi Friendly Mode

Scanners configured for Wi-Fi friendly mode behave as follows:

- The scanner remains in sniff mode, and exits sniff mode only during firmware update.
- If any Wi-Fi channel is excluded from the hopping sequence, AFH turns off.
- Scanner (and cradle) avoid the selected Wi-Fi channels after establishing connection.

Notes

- If using this feature, configure all scanners in the area for Wi-Fi friendly mode.
- By default, no Wi-Fi channels are excluded.
- Since Bluetooth requires a minimum of 20 channels when Wi-Fi channels 1, 6, and 11 are excluded, a smaller number of channels are cut from the hopping sequence.
- Updating Wi-Fi friendly settings before Bluetooth connection is recommended.

Scan a bar code below to enable or disable **Wi-Fi Friendly Mode**, then see [Wi-Fi Friendly Channel Exclusion](#) to select any channels to exclude.

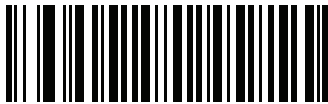

***Disable Wi-Fi Friendly Mode**



Enable Wi-Fi Friendly Mode

Wi-Fi Friendly Channel Exclusion

Select the channels to exclude:

- **Exclude Wi-Fi channel 1:** Bluetooth channels 0-21 are excluded from hopping sequence (2402-2423 MHz).
- **Exclude Wi-Fi channel 6:** Bluetooth channels 25-46 are excluded from hopping sequence (2427 - 2448 MHz).
- **Exclude Wi-Fi channel 11:** Bluetooth channels 50-71 are excluded from hopping sequence (2452 - 2473 MHz).
- **Exclude Wi-Fi channel 1, 6 and 11:** Bluetooth channels 2-19 (2404-2421 MHz), 26-45 (2428 - 2447 MHz) and 51-69 (2453 - 2471 MHz) are excluded from hopping sequence.
- **Exclude Wi-Fi channels 1 and 6:** Bluetooth channels 0-21 (2402-2423 MHz) and 25-46 (2427 - 2448 MHz) are excluded from hopping sequence.
- **Exclude Wi-Fi channels 1 and 11:** Bluetooth channels 0-21 (2402-2423 MHz) and 50-71 (2452 - 2473 MHz) are excluded from hopping sequence.
- **Exclude Wi-Fi channel 6 and 11:** Bluetooth channels 25-46 (2427 - 2448 MHz) and 50-71 (2452 - 2473 MHz) are excluded from hopping sequence.

Wi-Fi Friendly Channel Exclusion (continued)



***Use All Channels (Standard AFH)**

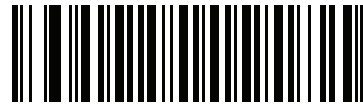

Exclude Wi-Fi Channel 1



Exclude Wi-Fi Channel 6

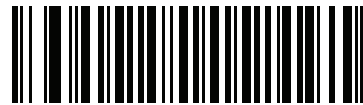

Exclude Wi-Fi Channel 11

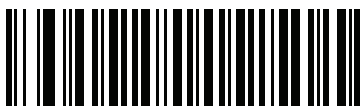

Exclude Wi-Fi Channels 1, 6, and 11

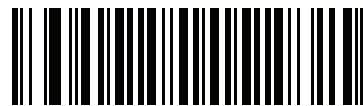

Exclude Wi-Fi Channels 1 and 6



Exclude Wi-Fi Channels 1 and 11

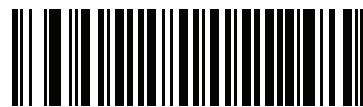

Exclude Wi-Fi Channels 6 and 11

HID Host Parameters

The digital scanner supports keyboard emulation over the Bluetooth HID profile. In this mode the digital scanner can interact with Bluetooth enabled hosts supporting the HID profile as a Bluetooth keyboard. Scanned data is transmitted to the host as keystrokes.

Following are the keyboard parameters supported by the HID host.

Apple iOS HID Feature

This option enables Apple iOS devices to open and close the iOS virtual keyboard by double-pressing the trigger.

✓ **NOTE** When this feature is enabled, the digital scanner may be incompatible with non-Apple iOS devices.



*Disable



Enable

Android HID Feature

This option allows simple Bluetooth pairing to the Android without requiring a PIN code.



*Disable



Enable

HID Country Keyboard Types (Country Codes)

Scan the bar code corresponding to the keyboard type.



***North American Standard Keyboards**



French Windows



French Canadian Windows 98

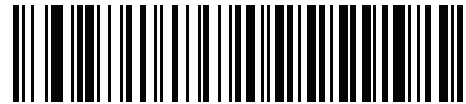

French International



German Windows

HID Country Keyboard Types (continued)



Spanish Windows



Italian Windows



Swedish Windows



UK English Windows



Japanese Windows



French Canadian Windows 2000/XP



Portuguese/Brazilian Windows

HID Keyboard Keystroke Delay

This parameter sets the delay, in milliseconds, between emulated keystrokes. Scan a bar code below to increase the delay when the HID host requires a slower transmission of data.



***No Delay (0 msec)**



Medium Delay (20 msec)



Long Delay (40 msec)

HID CAPS Lock Override

When enabled, the case of the data is preserved regardless of the state of the caps lock key. This setting is always enabled for the “Japanese, Windows (ASCII)” keyboard type and can not be disabled.



***Do Not Override Caps Lock Key
(Disable)**



**Override Caps Lock Key
(Enable)**

HID Ignore Unknown Characters

Unknown characters are characters the host does not recognize. When **Send Bar Codes With Unknown Characters** is scanned, all bar code data is sent except for unknown characters, and no error beeps sound. When **Do Not Send Bar Codes With Unknown Characters** is scanned, bar codes containing at least one unknown character are not sent to the host, and an error beep sounds.



***Send Bar Codes With Unknown Characters
(Enable)**



**Do Not Send Bar Codes With Unknown Characters
(Disable)**

Emulate Keypad

When enabled, all characters are sent as ASCII sequences over the numeric keypad. For example, ASCII A is sent as "ALT make" 0 6 5 "ALT Break."



***Disable Keypad Emulation**



Enable Keypad Emulation

HID Keyboard FN1 Substitution

When enabled, this parameter allows replacement of any FN1 character in an EAN128 bar code with a Key Category and value chosen by the user. See [FN1 Substitution Values on page 5-50](#) to set the Key Category and Key Value.



***Disable Keyboard FN1 Substitution**



Enable Keyboard FN1 Substitution

HID Function Key Mapping

ASCII values under 32 are normally sent as control-key sequences. When this parameter is enabled, the keys in bold are sent in place of the standard key mapping (see [Table 7-2 on page 7-19](#)).

Table entries that do not have a bold entry remain the same whether or not this parameter is enabled.



***Disable Function Key Mapping**



Enable Function Key Mapping

Simulated Caps Lock

When enabled, the digital scanner inverts upper and lower case characters on the digital scanner bar code as if the Caps Lock state is enabled on the keyboard. This inversion is done regardless of the current state of the keyboard Caps Lock state.



***Disable Simulated Caps Lock**



Enable Simulated Caps Lock

Convert Case

When enabled, the digital scanner converts all bar code data to the selected case.



***No Case Conversion**



Convert All to Upper Case



Convert All to LowerCase

Auto-reconnect Feature

When in SPP Master or Cradle Host mode, the digital scanner automatically tries to reconnect to a remote device when a disconnection occurs that is due to the radio losing communication. This can happen if the digital scanner goes out of range with the remote device, or if the remote device powers down. The digital scanner tries to reconnect for the period of time specified by the Reconnect Attempt Interval setting. During that time the green LED continues to blink.

If the auto-reconnect process fails due to page time-outs, the digital scanner sounds a page timeout beep (long low/long high) and enters low power mode. The auto-reconnect process can be re-started by pulling the digital scanner trigger.

If the auto-reconnect process fails because the remote device rejects the connection attempt, the digital scanner sounds a connection reject beep sequence (see [Wireless Beeper Definitions on page 4-3](#)) and deletes the remote pairing address. If this happens, a pairing bar code must be scanned to attempt a new connection to the remote device.

- ✓ **NOTE** If a bar code is scanned while the auto-reconnect sequence is in process, a transmission error beep sequence sounds and the data is not transmitted to the host. After a connection is reestablished, normal scanning operation returns. For error beep sequence definitions, see [Beeper Definitions on page 2-1](#).

The digital scanner has memory available for storing a remote Bluetooth address for each Master mode (SPP, Cradle). When switching between these modes, the digital scanner automatically tries to reconnect to the last device it was connected to in that mode.

- ✓ **NOTE** Switching between Bluetooth host types by scanning a host type bar code ([page 4-4](#)) causes the radio to be reset. Scanning is disabled during this time. It takes several seconds for the digital scanner to re-initialize the radio at which time scanning is enabled.

Reconnect Attempt Beep Feedback

When a digital scanner disconnects as it goes out of range, it immediately attempts to reconnect. While the digital scanner attempts to reconnect, the green LED continues to blink. If the auto-reconnect process fails, the digital scanner emits a page timeout beep (long low/long high) and stops blinking the LED. The process can be restarted by pulling the trigger.

The Beep on Reconnect Attempt feature is disabled by default. When enabled, the digital scanner emits 5 short high beeps every 5 seconds while the reconnection attempt is in progress. Scan a bar code below to enable or disable Beep on Reconnect Attempt.



***Disable Beep on Reconnect Attempt**



Enable Beep on Reconnect Attempt

Reconnect Attempt Interval

When a digital scanner disconnects as it goes out of range, it immediately attempts to reconnect for the default time interval of 30 seconds. This time interval can be changed to one of the following options:

- 30 seconds
- 1 minute
- 5 minutes
- 30 minutes
- 1 hour
- Indefinitely.

To set the Reconnect Attempt Interval, scan one of the bar codes below



***Attempt to Reconnect for 30 Seconds**



Attempt to Reconnect for 1 Minute



Attempt to Reconnect for 5 Minutes



Attempt to Reconnect for 30 Minutes



Attempt to Reconnect for 1 Hour



Attempt to Reconnect Indefinitely

Auto-reconnect in Bluetooth Keyboard Emulation (HID Slave) Mode

In Bluetooth Keyboard Emulation (HID Slave) mode, select a re-connect option for when the digital scanner loses its connection with a remote device:

- **Auto-reconnect on Bar Code Data:** The digital scanner auto-reconnects when you scan a bar code. With this option, a delay can occur when transmitting the first characters. The digital scanner sounds a decode beep upon bar code scan, followed by a connection, a page timeout, a rejection beep, or a transmission error beep. Select this option to optimize battery life on the digital scanner and mobile device. Note that auto-reconnect does not occur on rejection and cable unplug commands.
- **Auto-reconnect Immediately:** When the digital scanner loses connection, it attempts to reconnect. If a page timeout occurs, the digital scanner attempts reconnect on a trigger pull. Select this option if the digital scanner's battery life is not an issue and you do not want a delay to occur when the first bar code is transmitted. Note that auto-reconnect does not occur on rejection and cable unplug commands.
- **Disable Auto-reconnect:** When the digital scanner loses connection, you must re-establish it manually.

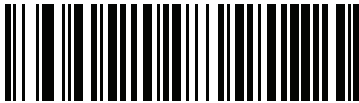

*Auto-reconnect on Bar Code Data

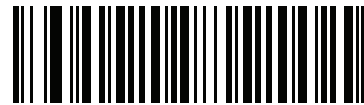

Auto-reconnect Immediately

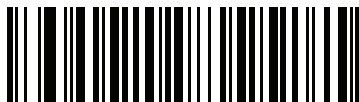

Disable Auto-reconnect

Out of Range Indicator

An out of range indicator can be set by scanning [Enable Beep on Reconnect Attempt on page 4-18](#) and extending the time using the [Reconnect Attempt Interval on page 4-19](#).

For example, with Beep on Reconnect Attempt disabled while the digital scanner loses radio connection when it is taken out of range, the digital scanner attempts to reconnect silently during the time interval set by scanning a Reconnect Attempt Interval.

When Beep on Reconnect Attempt is enabled, the digital scanner emits 5 high beeps every 5 seconds while the reconnection attempt is in progress. If the Reconnect Attempt Interval is adjusted to a longer period of time, such as 30 minutes, the digital scanner emits 5 high beeps every 5 seconds for 30 minutes providing an out of range indicator.

Digital Scanner(s) To Cradle Support

Modes of Operation

The charging cradle with radio supports two radio communication modes of operation, allowing the digital scanner to communicate wirelessly:

- Point-to-Point
- Multipoint-to-Point.

Point-to-Point Communication

In Point-to-Point communication mode, the cradle allows one digital scanner to connect to it at a time. In this mode, the digital scanner is paired to the cradle either by insertion into the cradle (if pairing on contacts is enabled, [page 4-24](#)), or by scanning the **PAIR** bar code. Communication can be locked, unlocked (default), or in a lock override state (see [Pairing Modes on page 4-23](#)). In locked mode, locking intervals must be set by scanning a connection maintenance interval bar code beginning on [page 4-26](#).

To activate this mode of operation, scan **Point-to-Point**.

Multipoint-to-Point Communication

Multipoint-to-Point communication mode allows up to three digital scanners to pair to one cradle for the CR0078-S and up to seven digital scanners for the CR0078-P.

To activate this mode, the first digital scanner connected to the cradle must scan the **Multipoint-to-Point** bar code. This mode allows a parameter broadcast ([page 4-22](#)) feature that forwards parameter bar code settings to all connected digital scanners. In this mode, programming one digital scanner applies the settings to all connected digital scanners.

To select Point-to-Point or Multipoint-to-Point mode, scan the appropriate bar code.



Multipoint-to-Point Mode



***Point-to-Point Mode**

Parameter Broadcast (Cradle Host Only)

When in multipoint-to-point mode, enable Parameter Broadcast to broadcast all parameter bar codes scanned to all other digital scanners in the piconet. If disabled, parameter bar codes are processed by the individual digital scanner only, and the digital scanner ignores parameters broadcast from other digital scanners or from the cradle.



***Enable Parameter Broadcast**



Disable Parameter Broadcast

Pairing

Pairing is the process by which a digital scanner initiates communication with a cradle. Scanning **Multipoint-to-Point** activates multi digital scanner-to-cradle operation and allows up to three digital scanners to pair to one cradle for the CR0078-S and up to seven digital scanners for the CR0078-P.

To pair the digital scanner with the cradle, scan the pairing bar code. A high/low/high/low beep sequence indicates that the pairing bar code was decoded. When a connection between the cradle and digital scanner is established, a low/high beep sounds.

- ✓ **NOTE**
1. The pairing bar code that connects the digital scanner to a cradle is unique to each cradle.
 2. Do not scan data or parameters until pairing completes.
 3. When the digital scanner is paired to the cradle in SPP Master or Cradle Host mode, the digital scanner automatically tries to reconnect to a remote device when a disconnection occurs that is due to the radio losing communication. For more information see [Auto-reconnect Feature on page 4-17](#).

Pairing Modes

When operating with the cradle, two modes of pairing are supported:

- **Locked Pairing Mode** - When a cradle is paired (connected) to the digital scanner (or up to three digital scanners for the CR0078-S and up to seven digital scanners for the CR0078-P in Multipoint-to-Point mode), any attempt to connect a different digital scanner, by either scanning the **PAIR** bar code on the cradle or by inserting it into the cradle with the pairing on contacts feature enabled ([page 4-24](#)), is rejected. The currently connected digital scanner(s) maintain connection. In this mode, you must set a [Connection Maintenance Interval on page 4-26](#).
- **Unlocked Pairing Mode** - Pair (connect) a new digital scanner to a cradle at any time by either scanning the **PAIR** bar code on the cradle or by inserting it into the cradle with the pairing on contacts feature enabled. This unpairs the previous digital scanner from the cradle (Point-to-Point mode only).

To set the cradle pairing mode, scan the appropriate bar code below.



***Unlocked Pairing Mode**



Locked Pairing Mode

Lock Override

Lock Override overrides a locked digital scanner base pairing and connects a new digital scanner. In Multipoint-to-Point mode, this unpairs any disconnected (out of range) digital scanner first, in order to connect the new digital scanner.

To use **Lock Override**, scan the bar code below, followed by the pairing bar code on the cradle.



LockOverride

Pairing Methods

There are two pairing methods. The default method allows the digital scanner and cradle to pair (connect) when the pairing bar code on the cradle is scanned. A second method pairs the digital scanner and cradle when the digital scanner is inserted in the cradle. To enable this feature, scan **Enable Pair On Contacts** below. With this feature enabled it is not necessary to scan the pairing bar code on the cradle. If the pairing is successful, a low/high connection beep sequence sounds a few seconds after the digital scanner is placed in the cradle. See [Wireless Beeper Definitions on page 4-3](#) for other beep sequences.

To enable or disable pairing on contacts, scan the appropriate bar code below.



***Enable Pair On Contacts**



Disable Pair on Contacts

Unpairing

Unpair the digital scanner from the cradle or PC/host to make the cradle available for pairing with another digital scanner. Scan the bar code below to disconnect the digital scanner from its cradle/PC host.

An unpairing bar code is also included in the *DS6878 Quick Reference Guide*.



Unpairing

Pairing Bar Code Format

When the digital scanner is configured as an SPP Master, you must create a pairing bar code for the remote Bluetooth device to which the digital scanner can connect. The Bluetooth address of the remote device must be known. Pairing bar codes are Code 128 bar codes and are formatted as follows:

<Fnc 3>Bxxxxxxxxxxx

where:

- **B** (or **LNKB**) is the prefix
- **xxxxxxxxxxx** represents the 12-character Bluetooth address.

Pairing Bar Code Example

If the remote device to which the digital scanner can connect has a Bluetooth address of 11:22:33:44:55:66, then the pairing bar code is:

Pairing Bar Code Content: 
'B' + Bluetooth Address **B112233445566**

Connection Maintenance Interval

- ✓ **NOTE** The Connection Maintenance Interval only applies in locked pairing mode (see [page 4-23](#)).

When a digital scanner disconnects from a cradle due to a Link Supervision Timeout, the digital scanner immediately attempts to reconnect to the cradle for 30 seconds. If the auto-reconnect process fails, it can be restarted by pulling the digital scanner trigger.

To guarantee that a disconnected digital scanner can reconnect when it comes back in range, the cradle reserves the connection for that digital scanner for a period of time defined by the Connection Maintenance Interval. If the cradle is supporting the maximum three digital scanners and one digital scanner disconnects, a fourth digital scanner cannot pair to the cradle during this interval. To connect another digital scanner: either wait until the connection maintenance interval expires then scan the **PAIR** bar code on the cradle with the new digital scanner; or, scan **Lock Override** ([page 4-23](#)) with the new digital scanner then scan the **PAIR** bar code on the cradle.

- ✓ **NOTE** When the CR0078-S cradle supports the maximum three digital scanners and the CR0078-P supports the maximum seven digital scanners, it stores the remote pairing address of each digital scanner in memory regardless of the digital scanner condition (e.g., discharged battery). When you want to change the digital scanners paired to the cradle, unpair each digital scanner currently connected to the cradle by scanning the [Unpairing](#) bar code prior and reconnect each appropriate digital scanner by scanning the PAIR bar code on the cradle.

Connection Maintenance Interval options are:

- 15 minutes
- 30 minutes
- One hour
- Two hours
- Four hours
- Eight hours
- 24 hours
- Indefinitely.

Considerations

The system administrator determines the Connection Maintenance Interval. A shorter interval allows new users to gain access to abandoned connections more quickly, but causes problems if users leave the work area for extended periods. A longer interval allows existing users to leave the work area for longer periods of time, but ties up the system for new users.

To avoid this conflict, users who are going off-shift can scan the unpair bar code on [page 4-24](#) to ignore the Connection Maintenance Interval and make the connection immediately available.

To set the Connection Maintenance Interval, scan one of the bar codes below



***Set Interval to 15 Minutes**



Set Interval to 30 Minutes



Set Interval to 60 Minutes



Set Interval to 2 Hours



Set Interval to 4 Hours



Set Interval to 8 Hours



Set Interval to 24 Hours



Set Interval to Forever

Page Button

The CR0078-P cradle offers a page button (see [CR0078-P Series Cradle on page 1-6](#)). The page button is a sensor that when touched, causes paired scanners to emit a beeping sequence. The default is **Disable Page Button**.

1. Place your finger over the button sensor .
2. Press down for approximately 1 second.
3. The cradle LED will turn blue when the scanner is out of the cradle. The paired scanner will beep five times. If multiple scanners are paired to the cradle, all the scanners will beep five times.
4. Repeat as necessary.

✓ **NOTE** Scanners out of radio range will not beep when paged. Refer to [Technical Specifications on page 3-9](#) for detailed radio range information.

Scan one of the following bar codes to enable or disable this feature.



***Disable Page Button**

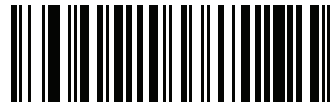

Enable Page Button

Bluetooth Security

The digital scanner supports Bluetooth Authentication and Encryption. Authentication can be requested by either the remote device or the digital scanner. When Authentication is requested, the digital scanner uses its programmed PIN code to generate a link key. Once Authentication is complete, either device may then negotiate to enable Encryption.

✓ **NOTE** A remote device can still request Authentication.

Authentication

To force Authentication with a remote device (including the cradle), scan the **Enable Authentication** bar code below. To prevent the digital scanner from forcing Authentication, scan the **Disable Authentication** bar code below.



Enable Authentication



***Disable Authentication**

PIN Code

To set the PIN code (e.g., password) on the digital scanner, scan the bar code below followed by five alphanumeric programming bar codes (see [Appendix E, Alphanumeric Bar Codes](#)). The default PIN code is **12345**.

If the digital scanner communicates with a cradle with security enabled, synchronize the PIN codes on the digital scanner and cradle. To achieve this, connect the digital scanner to the cradle when setting the PIN codes. If the digital scanner is not connected to a cradle, the PIN code change only takes effect on the digital scanner. If security is required between the digital scanner and cradle, and the PIN codes do not match, pairing fails. If the PIN codes are not synchronized, re-synchronize them by disabling security, establishing a connection to the cradle, and then programming a new PIN code.



Set PIN Code

Variable PIN Code

The default PIN code is the user-programmed Static PIN Code. Typically, however, HID connections require entering a Variable PIN Code. If, when attempting connection, the application presents a text box that includes a PIN, scan the **Variable PIN Code** bar code, then re-attempt connection. When you hear a beep indicating the digital scanner is waiting for an alphanumeric entry, enter the provided variable PIN using the [Alphanumeric Bar Codes on page E-1](#), then scan [End of Message on page E-7](#) if the code is less than 16 characters. The digital scanner discards the variable PIN code after connection.



***Static PIN Code**



Variable PIN Code

Encryption

✓ **NOTE** Authentication must be performed before Encryption can take effect.

To set up the digital scanner for enabling Encryption, scan **Enable Encryption**. To prevent the digital scanner from enabling Encryption, scan **Disable Encryption**. When enabled, the radio encrypts data.



Enable Encryption



*** Disable Encryption**

Secure Simple Pairing IO Capability (SPP Server and SPP Master Host Mode Only)

Bluetooth 2.1 uses the *Secure Simple Pairing* method to authenticate devices and create an encryption key. As a part of that algorithm, the device must state its IO capabilities. When in Serial Profile Host (master or slave), the default is **No Input/No Output** and no user interaction is required; however, a device may prompt the user to confirm the pairing process.

Keyboard Only (passkey entry) is used between a device with a display and a device with numeric keypad entry (such as a keyboard), or two devices with numeric keypad entry. In the first case, the display shows a 6-digit numeric code to the user, who then enters the code on the keypad. In the second case, the user of each device enters the same 6-digit number.

✓ **NOTE** Use this option to connect to an Android tablet.

- **No Input/No Output:** Least amount of security (may not be acceptable for some devices).
- **Keyboard Only:** Higher level of security.

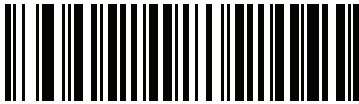

* No Input/No Output



Keyboard Only

Connecting an iOS or Android Product With the Digital Scanner

Perform the following steps on each device to establish a link.

HID Keyboard Emulation

On the DS6878, scan [Bluetooth Keyboard Emulation \(HID Slave\) on page 4-5](#). Next:

- On an iOS/iPad/iPhone, select *Settings > General > Bluetooth* and turn Bluetooth *On*. Choose the DS6878 digital scanner from the list of discovered devices. This establishes a link allowing scanning into any application with keyboard entry.
- On an Android/ Motorola ET1/Droid, select *Settings > Wireless & networks > Bluetooth* (to turn Bluetooth on, if not already on). Select *Bluetooth Settings* and choose the DS6878 digital scanner from the list of discovered devices. (The DS6878 digital scanner normally displays as DS6878 - xxxxxx, where xxxxxx is the serial number.)



IMPORTANT Android devices, specifically the Motorola ET1, may require scanning a PIN to connect. If so, a PIN displays on the device. Scan [Variable PIN Code on page 4-30](#) then re-attempt connection. A beep indicates the scanner is waiting for PIN entry. Scan the PIN using the [Alphanumeric Keyboard on page E-1](#). To delete incorrect scanned entries, scan [Cancel on page E-7](#).

For more information, see [Variable PIN Code on page 4-30](#).

CHAPTER 5 USER PREFERENCES & MISCELLANEOUS DIGITAL SCANNER OPTIONS

Introduction

If desired, program the digital scanner to perform various functions, or activate different features. This chapter describes imaging preference features and provides programming bar codes for selecting these features.

The digital scanner ships with the settings in *Configure the digital scanner using the 123Scan2 configuration program (see 123Scan2 on page 13-1). on page 5-2* (also see *Appendix A, Standard Default Parameters* for all host device and miscellaneous defaults). If the default values suit requirements, programming is not necessary.

To set feature values, scan a single bar code or a short bar code sequence. The settings are stored in non-volatile memory and are preserved even when you power down the digital scanner.

✓ **NOTE** Most computer monitors allow scanning the bar codes directly on the screen. When scanning from the screen, be sure to set the document magnification to a level where you can see the bar code clearly, and bars and/or spaces are not merging.

If not using a USB cable, select a host type (see each host chapter for specific host information) after the power-up beeps sound. This is only necessary upon the first power-up when connecting to a new host.

To return all features to default values, scan the *Default Parameters on page 5-5*. Throughout the programming bar code menus, asterisks (*) indicate default values.

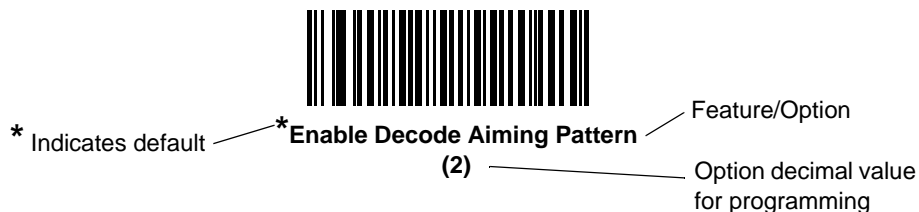

Scanning Sequence Examples

In most cases scanning one bar code sets the parameter value. For example, to set the beeper tone to high, scan the High Frequency (beeper tone) bar code listed under [Beeper Tone on page 5-8](#). The digital scanner issues a fast warble beep and the LED turns green, signifying a successful parameter entry.

Other parameters require scanning several bar codes. See these parameter descriptions for this procedure.

Errors While Scanning

Unless otherwise specified, to correct an error during a scanning sequence, just re-scan the correct parameter.

User Preferences/Miscellaneous Option Parameter Defaults

[Table 5-1](#) lists the defaults for preferences parameters. To change the default values:

- Scan the appropriate bar codes in this guide. These new values replace the standard default values in memory. To recall the default parameter values, scan the [Default Parameters on page 5-5](#).
- Configure the digital scanner using the 123Scan² configuration program (see [123Scan2 on page 13-1](#)).

✓ **NOTE** See [Appendix A, Standard Default Parameters](#) for all user preferences, hosts, symbologies, and miscellaneous default parameters.

Table 5-1 User Preferences Default Parameters

Parameter	Parameter Number	Default	Page Number
User Preferences			
Set Default Parameter		Set Defaults	5-5
Parameter Bar Code Scanning	236	Enable	5-6
Beep After Good Decode	56	Enable	5-6
Suppress Power Up Beeps	721	Do Not Suppress	5-7
Beeper Tone	145	Medium	5-8
Beeper Volume	140	High	5-9
Beeper Duration	628	Medium	5-10
Beep on Insertion	288	Enable	5-10
Decode Pager Motor	613	Disable	5-11
Decode Pager Motor Duration	626	150 msec	5-11
Night Mode Trigger	1215	Disable	5-14
Night Mode Toggle	N/A	N/A	5-14
Batch Mode	544	Normal (Do Not Batch Data)	5-15

Table 5-1 *User Preferences Default Parameters (Continued)*

Parameter	Parameter Number	Default	Page Number
Hand-held Trigger Mode	138	Level	5-17
Hands-free Mode	630	Enable	5-18
Presentation Performance Mode	650	Standard	5-19
Low Power Mode	128	Enabled	5-20
Time Delay to Hand-held Low Power Mode	146	100 msec	5-20
Time Delay to Presentation Idle Mode	663	1 Minute	5-23
Time Delay to Presentation Sleep Mode	662	1 Hour	5-25
Timeout to Low Power Mode from Auto Aim	729	15 Sec	5-27
Picklist Mode	402	Disabled Always	5-28
Mobile Phone/Display Mode	716	Disable	5-29
FIPS Mode	736	Enabled	5-30
PDF Prioritization	719	Disable	5-31
PDF Prioritization Timeout	720	200 msec	5-31
Continuous Bar Code Read	649	Disable	5-32
Unique Bar Code Reporting	723	Disable	5-32
Decode Session Timeout	136	9.9 Sec	5-33
Timeout Between Decodes, Same Symbol	137	0.5 Sec	5-33
Timeout Between Decodes, Different Symbols	144	0.2 Sec	5-33
Fuzzy 1D Processing	514	Enable	5-34
Hand-held Decode Aiming Pattern	306	Enable	5-34
Hands-free Decode Aiming Pattern	590	Enable	5-35
Presentation Mode Field of View	609	Full	5-36
Decoding Illumination	298	Enable	5-37
Multicode Mode	677	Disable	5-37
Multicode Expression	661	1	5-38
Multicode Mode Concatenation	717	Disable	5-43
Multicode Concatenation Symbology	722	Concatenate as PDF417	5-44

Table 5-1 *User Preferences Default Parameters (Continued)*

Parameter	Parameter Number	Default	Page Number
Miscellaneous Options			
Transmit Code ID Character	45	None	5-47
Prefix Value	99,105	7013 <CR><LF>	5-48
Suffix 1 Value Suffix 2 Value	98, 104 100, 106	7013 <CR><LF>	5-48
Scan Data Transmission Format	235	Data as is	5-49
FN1 Substitution Values	103, 109	Set	5-50
Transmit "No Read" Message	94	Disable	5-51
Unsolicited Heartbeat Interval	1118	Disable	5-52
Dump Scanner Parameters			5-53
Report Version			5-53

User Preferences

Default Parameters

The scanner can be reset to two types of defaults: factory defaults or custom defaults. Scan the appropriate bar code below to reset the scanner to its default settings and/or set the scanner's current settings as the custom default.

- **Restore Defaults** - Resets all default parameters as follows:
 - If custom default values were configured (see **Write to Custom Defaults**), the custom default values are set for all parameters each time the **Restore Defaults** bar code below is scanned.
 - If no custom default values were configured, the factory default values are set for all parameters each time the **Restore Defaults** bar code below is scanned. (For factory default values, see [Chapter A, Standard Default Parameters](#) beginning on [page A-1.](#))
- **Set Factory Defaults** - Scan the **Set Factory Defaults** bar code below to eliminate all custom default values and set the scanner to factory default values. (For factory default values, see [Chapter A, Standard Default Parameters](#) beginning on [page A-1.](#))
- **Write to Custom Defaults** - Custom default parameters can be configured to set unique default values for all parameters. After changing all parameters to the desired default values, scan the **Write to Custom Defaults** bar code below to configure custom defaults.



*Restore Defaults



Set Factory Defaults



Write to Custom Defaults

Parameter Bar Code Scanning

Parameter # 236

To disable the decoding of parameter bar codes, including the **Set Defaults** parameter bar codes, scan the **Disable Parameter Scanning** bar code below. To enable decoding of parameter bar codes, scan **Enable Parameter Scanning**.



***Enable Parameter Bar Code Scanning
(1)**



**Disable Parameter Bar Code Scanning
(0)**

Beep After Good Decode

Parameter # 56

Scan a bar code below to select whether or not the digital scanner beeps after a good decode. If selecting **Do Not Beep After Good Decode**, the beeper still operates during parameter menu scanning and to indicate error conditions.



***Beep After Good Decode
(Enable)
(1)**

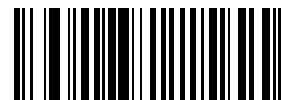

**Do Not Beep After Good Decode
(Disable)
(0)**

Suppress Power Up Beeps

Parameter # 721

Scan a bar code below to select whether or not to suppress digital scanner beeps upon power up.



***Do Not Suppress Power Up Beeps
(0)**



**Suppress Power Up Beeps
(1)**

Beeper Tone

Parameter # 145

To select a decode beep frequency (tone), scan one of the following bar codes. To disable the Beeper Tone, scan the **Off** parameter.



Off
(3)

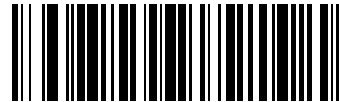

Low Tone
(2)

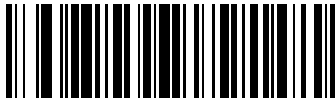

***Medium Tone**
(1)



High Tone
(0)

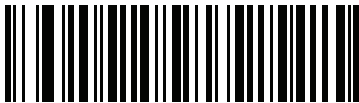

Medium to High Tone (2-tone)
(4)

Beeper Volume

Parameter # 140

To select a beeper volume, scan the **Low Volume**, **Medium Volume**, or **High Volume** bar code.



Low Volume
(2)



Medium Volume
(1)



***High Volume**
(0)

Beeper Duration

Parameter # 628

To select the duration for the beeper, scan one of the following bar codes.

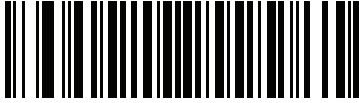

**Short
(0)**



*** Medium
(1)**

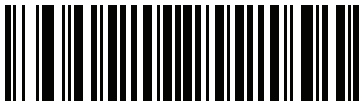

**Long
(2)**

Beep on Insertion

Parameter # 288

When a digital scanner is inserted into a cradle and detects power, it emits a short low beep. This feature is enabled by default.

To enable or disable beeping on insertion, scan the appropriate bar code below.



***Enable Beep on Insertion
(1)**



**Disable Beep on Insertion
(0)**

Decode Pager Motor

Parameter # 613

For DS6878-HC units only, manufactured after xx/xx/2013

The scanner includes a pager motor which, when enabled, vibrates the scanner for a period of time when a successful decode occurs.

Scan a bar code below to enable or disable the pager motor. If enabled, scan the appropriate bar code to set the period of time in which to vibrate the scanner (see [Decode Pager Motor Duration](#) below).



***Pager Motor Disable
(0)**



**Pager Motor Enable
(1)**

Decode Pager Motor Duration

Parameter # 626

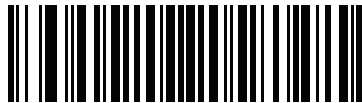

***150 msec
(15)**



**200 msec
(20)**

Decode Pager Motor Duration (continued)



250 msec
(25)

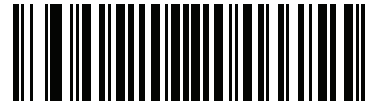

300 msec
(30)



400 msec
(40)



500 msec
(50)

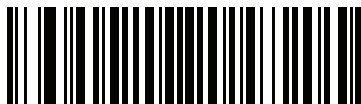

600 msec
(60)



750 msec
(75)

Night Mode

For DS6878-HC units only, manufactured after xx/xx/2013

The Night Mode feature allows the user to easily switch to a “quiet mode” in order to use the pager motor with the beeper off.

Enter and exit Night Mode in one of two ways:

- If *Night Mode Trigger* is enabled, you can use the trigger to toggle between entering and exiting Night Mode. To do this, point the digital scanner away from a bar code and pull the trigger until the beam goes off. Continue to pull the trigger for an additional 5 seconds.



NOTE After decoding a bar code, pulling the trigger an additional 5 seconds has no affect.

- Scan the *Night Mode Toggle* bar code to enter or exit Night Mode, regardless of the state of the *Night Mode Trigger* parameter.

Entering Night Mode makes the following changes to the digital scanner:

- *Decode Pager Motor* is enabled.
- *Beep After Good Decode* is disabled.
- *Beep on Insertion* is disabled.
- Scanning the pairing bar code activates the pager motor instead of the warble beep, and on pairing connection, the pager motor activates again.

Also note the following scanner behavior regarding night mode:

- Exiting Night Mode returns the scanner to the previously programmed states for the three parameters changed (for example, if *Beep After Good Decode* was enabled before entering Night Mode, it returns to enabled upon exiting night mode).
- When entering Night Mode, the pager motor vibrates. When exiting Night Mode, the scanner emits two short beeps.
- Scanning a *Default Parameters* bar code or removing the battery causes the scanner to exit Night Mode.
- For scanners that do not use a pager motor, scanning any of the Night Mode parameters or the pager motor parameters results in an error beep.
- If the scanner loses power while in Night Mode due to a dead battery or the *Battery Off* bar code being scanned, on the next power up the scanner exits Night Mode and resumes normal operation.

Night Mode Trigger

Parameter # 1215

For DS6878-HC units only, manufactured after xx/xx/2013

Enable this to use the trigger to toggle between entering and exiting Night Mode. To toggle, point the scanner away from a bar code, pull the trigger until the beam goes off, and then continue pulling the trigger for an additional 5 seconds. Note that pulling the trigger an additional 5 seconds after decoding a bar code has no affect.

When entering Night Mode, the pager motor vibrates. When exiting Night Mode, the scanner emits 2 short beeps.



**Enable Night Mode Trigger
(1)**



***Disable Night Mode Trigger
(0)**

Night Mode Toggle

For DS6878-HC units only, manufactured after xx/xx/2013

To toggle between entering and exiting Night Mode without using the trigger, scan this bar code. This functions regardless of the state of the **Night Mode Trigger** parameter.

When scanning this bar code, the Pager Motor vibrates when entering Night Mode, and the scanner emits 2 short beeps when exiting Night Mode.



Toggle Night Mode

Batch Mode

Parameter # 544

The digital scanner supports three versions of batch mode. When the digital scanner is configured for any of the batch modes, it attempts to store bar code data (not parameter bar codes) until transmission is initialized, or the maximum number of bar codes are stored. When a bar code is saved successfully, a good decode beep sounds and the LED flashes green. If the digital scanner is unable to store a new bar code, a low/high/low/high out of memory beep sounds. (See pages 2-1, 2-3 and 4-3 for all beeper and LED definitions.)

In all modes, calculate the amount of data (number of bar codes) the digital scanner can store as follows:

Number of storable bar codes = 30,720 bytes of memory / (number of characters in the bar code + 3).

- ✓ **NOTE** If the batch mode selection is changed while there is batched data, the new batch mode will take effect only after all the previously batched data is sent.

Modes of Operation

- **Normal (default)** - Do not batch data. The digital scanner attempts to transmit every scanned bar code.
- **Out of Range Batch Mode** - The digital scanner starts storing bar code data when it loses its connection to a remote device (for example, when a user holding the digital scanner walks out of range). Data transmission is triggered by reestablishing the connection with the remote device (for example, when a user holding the digital scanner walks back into range).
- **Standard Batch Mode** - The digital scanner starts storing bar code data after **Enter Batch Mode** is scanned. Data transmission is triggered by scanning **Send Batch Data**.

- ✓ **NOTE** Transmission is halted if the connection to the remote device is lost.

- **Cradle Contact Batch Mode** - The digital scanner starts storing bar code data when **Enter Batch Mode** is scanned. Data transmission is triggered by insertion of the digital scanner into the cradle.

- ✓ **NOTE** If the digital scanner is removed from the cradle during batch data transfer, transmission halts until the digital scanner is re-inserted in the cradle.

In all modes, transmissions are halted if the digital scanner is moved out of range. The digital scanner resumes when it is back in range. If a bar code is scanned while batch data is transmitted it is appended to the end of the batched data; parameter bar codes are not stored.

Batch Mode (continued)



***Normal
(0)**



**Out of Range Batch Mode
(1)**



**Standard Batch Mode
(2)**



**Cradle Contact Batch Mode
(3)**



Enter Batch Mode



Send Batch Data

Hand-held Trigger Mode

Parameter # 138

Select one of the following trigger modes for the digital scanner:

- **Standard (Level)** - A trigger pull activates decode processing. Decode processing continues until the bar code decodes, you release the trigger, or the Decode Session Timeout occurs.
- **Auto Aim** - If the primary trigger (trigger A) is set to imager, this trigger mode turns on the laser aiming pattern when you lift the digital scanner. A trigger pull activates decode processing. After 2 seconds of inactivity the aiming pattern shuts off.



***Standard (Level)**
(0)



Auto Aim
(9)

Hands-free Mode

Parameter # 630

In hands-free mode, the digital scanner automatically triggers when presented with a bar code. Lifting the digital scanner causes it to behave according to the setting of the [Hand-held Trigger Mode on page 5-17](#).

✓ **NOTE** The CR0078-P cradle is required for hands-free mode.

If you select **Disable Hands-free Mode**, the digital scanner behaves according to the setting of the [Hand-held Trigger Mode](#) regardless of whether it is hand-held or on a countertop.

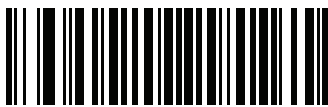

*Enable Hands-free Mode
(1)

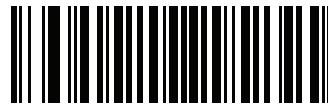

Disable Hands-free Mode
(0)

Presentation Performance Mode

Parameter # 650

Select one of the following Presentation Performance Mode options:

- **Standard Presentation Mode** is optimized for general purpose scanning, i.e., reading bar codes from standard surfaces such as paper labels or hang tags. This mode balances bar code swipe speed (the speed a bar code can pass through the field of view and still be read) and decode range (distance between the digital scanner and the bar code) for optimal performance on standard paper-based bar codes.
- **Enhanced Presentation Mode** is also optimized for general purpose (paper-based) scanning but provides for a faster bar code swipe speed and shorter decode range than **Standard Presentation Mode**. This mode is recommended for applications requiring the highest bar code swipe speed (e.g., automated scanning) or a reduced decode range (e.g., to better match EAS deactivation range or reduce the occurrence of inadvertent reads during hands-free operation).
- **Traditional Presentation Mode** is optimized for applications that require frequent reading of bar codes from mobile phones or PC displays. This mode allows more time for the digital scanner to analyze each bar code, improving performance on challenging bar codes such as those on a mobile phone display where the backlight has dimmed. This mode is also recommended for applications that include many truncated or poor quality bar codes. Because swipe speed is reduced, present bar codes to the digital scanner rather than swiping them when using this mode.

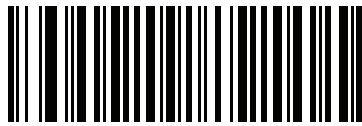

*Standard Presentation Mode
(2)

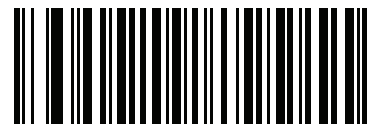

Enhanced Presentation Mode
(0)



Traditional Presentation Mode
(3)

Low Power Mode

Parameter # 128

If enabled, the digital scanner enters a low power consumption mode after Sleep Mode has expired, in which the LEDs turn off in order to conserve energy and prolong the life of the scanner. The digital scanner wakes when it is lifted, senses a trigger pull, or when the host attempts to communicate.

If disabled, power remains on after each decode attempt.



Disable Low Power Mode
(0)



***Enable Low Power Mode**
(1)

Time Delay to Hand-held Low Power Mode

Parameter # 146

This parameter sets the time it takes the digital scanner to enter reduced power mode after any scanning activity. Scan the appropriate bar code below to set the time.

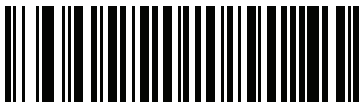

***100 msec**
(65)



500 msec
(69)

Time Delay to Hand-held Low Power Mode (continued)



1 sec
(17)

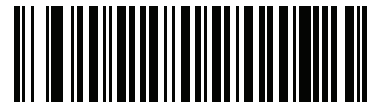

2 secs
(18)



3 secs
(19)

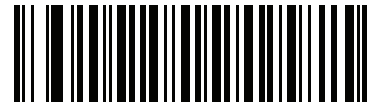

4 secs
(20)



5 secs
(21)

Digital Scanner Activity Modes

The digital scanner is capable of four modes of activity:

- **Active Mode** - The digital scanner uses full illumination for active scanning.
- **Idle Mode** - In presentation mode only, the digital scanner's illumination dims after a programmable time period. See [Time Delay to Presentation Idle Mode on page 5-23](#). The digital scanner wakes when it is lifted or senses motion, upon presentation of a bar code, or upon a trigger pull.
- **Sleep Mode** - In presentation mode only, the digital scanner's illumination shuts off after a programmable time period after Idle Mode has expired. See [Time Delay to Presentation Sleep Mode on page 5-25](#). The digital scanner wakes when it is lifted or senses motion, upon presentation of a bar code (depending on ambient light conditions), or upon a trigger pull.
- **Low Power Mode** - The digital scanner enters a low power consumption mode after Sleep Mode has expired, in which the LEDs turn off in order to conserve energy and prolong the life of the scanner. See [Low Power Mode](#). In hand-held mode, this occurs immediately after the programmed [Time Delay to Hand-held Low Power Mode](#). In presentation mode, this occurs after idle mode and sleep mode. The digital scanner wakes when it is lifted, senses a trigger pull, or when the host attempts to communicate.

✓ **NOTE** The digital scanner does not use Low Power Mode when connected to a USB or IBM host.

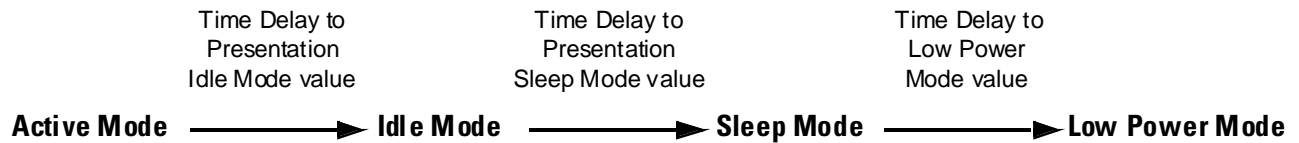

Note: Time delays are cumulative.

Figure 5-1 Power Levels

Time Delay to Presentation Idle Mode

Parameter # 663

In Presentation Mode, this parameter sets the time the digital scanner remains active before entering idle mode with dim illumination. The digital scanner wakes upon presentation of a bar code or a trigger pull.)



Disable
(0)



1 Second
(1)

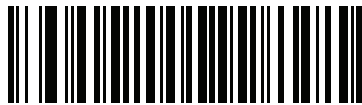

10 Seconds
(10)

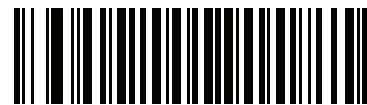

***1 Minute**
(17)

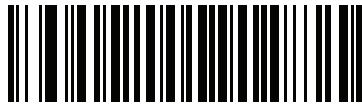

5 Minutes
(21)



15 Minutes
(27)

Time Delay to Presentation Idle Mode (continued)



**30 Minutes
(29)**

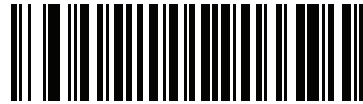

**45 Minutes
(30)**



**1 Hour
(33)**

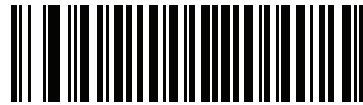

**3 Hours
(35)**

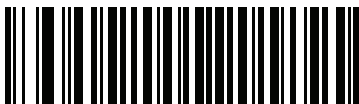

**6 Hours
(38)**

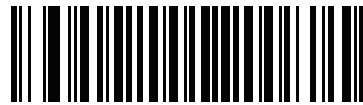

**9 Hours
(41)**

Time Delay to Presentation Sleep Mode

Parameter # 662

In Presentation Mode, this parameter sets the time the digital scanner remains active before entering sleep mode with no illumination. The digital scanner wakes when it senses motion, upon presentation of a bar code, or a trigger pull.

✓ **NOTE** Digital scanner performance is not guaranteed in dim conditions.



Disable
(0)

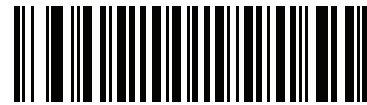

1 Second
(1)



10 Seconds
(10)

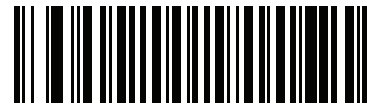

1 Minute
(17)



5 Minutes
(21)

Time Delay to Presentation Sleep Mode (continued)



**15 Minutes
(27)**



**30 Minutes
(29)**

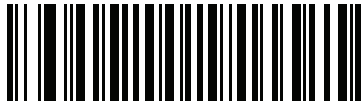

**45 Minutes
(30)**



***1 Hour
(33)**

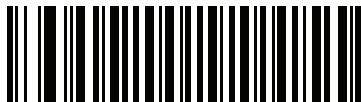

**3 Hours
(35)**



**6 Hours
(38)**



**9 Hours
(41)**

Timeout to Low Power Mode from Auto Aim

Parameter # 729

This parameter sets the time the digital scanner remains in auto aim before entering low power mode.



Disabled
(0)



5 secs
(85)



***15 secs**
(11)



30 secs
(13)



1 minute
(17)

Picklist Mode

Parameter # 402

Picklist mode enables the digital scanner to decode only bar codes that are aligned under the laser crosshair. Select one of the following picklist modes for the digital scanner:

- **Disabled Always** - Picklist mode is always disabled.
- **Enabled in Hand-held Mode** - Picklist mode is enabled when the digital scanner is out of hands-free mode and disabled when the digital scanner is in presentation mode.
- **Enabled in Hands-free Mode** - Picklist mode is enabled when the digital scanner is in hands-free mode only.
- **Enabled Always** - Picklist mode is always enabled.



*** Disabled Always
(0)**

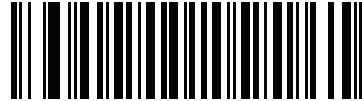

**Enabled in Hand-held Mode
(1)**

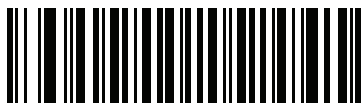

**Enabled in Hands-free Mode
(3)**



**Enabled Always
(2)**

Mobile Phone/Display Mode

Parameter # 716

This mode improves bar code reading performance off mobile phones and electronic displays. Enable this in hand-held, hands-free, or both modes, or disable this mode.



***Disable Mobile Phone/Display Mode
(0)**

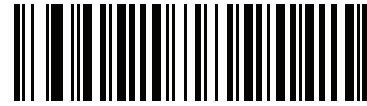

**Enable in Hand-held Mode
(1)**

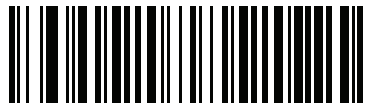

**Enable in Hands-free Mode
(2)**

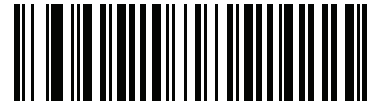

**Enable in Both Modes
(3)**

FIPS Mode

Parameter # 736

The Federal Information Processing Standard (FIPS) 140-2 is a U.S. government computer security standard used to accredit cryptographic modules. FIPS enabled DS6878 scanners and cradles offer this secure mode of operation.

✓ **NOTE** The CR0078-P cradle is required for FIPS mode.

To enable the FIPS mode of operation (enabled by default), scan the **Enable FIPS** bar code. The scanner will attempt to establish a secure session with the cradle to which it is connected. On success, the scanner will light a yellow LED on every trigger pull to signal that all data will be transmitted over Bluetooth in a secure fashion. On failure, the scanner will sound transmission failure error message on every attempt to transmit data.

To disable the FIPS mode, scan the **Disable FIPS** bar code at any time.



*Enable FIPS
(1)



Disable FIPS
(0)

PDF Prioritization

Parameter # 719

Enable this feature to delay decoding a 1D bar code (Code 128) by the value specified in [PDF Prioritization Timeout](#). During that time the digital scanner attempts to decode a PDF417 symbol (e.g., on a US driver's license), and if successful, reports this only. If it does not decode (can not find) a PDF417 symbol, it reports the 1D symbol after the timeout. The 1D symbol must be in the device's field of view for the digital scanner to report it. This parameter does not affect decoding other symbologies.



NOTE

The 1D Code 128 bar code lengths include the following:

- 7 to 10 characters
- 14 to 17 characters
- 27 to 28 characters

In addition, a Code 39 bar code with the following lengths are considered to potentially be part of a US driver's license:

- 8 characters
- 12 characters



*Disable PDF Prioritization
(0)



Enable PDF Prioritization
(1)

PDF Prioritization Timeout

Parameter # 720

When [PDF Prioritization](#) is enabled, this timeout specifies how long the digital scanner attempts to decode a PDF417 symbol before reporting the 1D bar code in the field of view.

Scan the following bar code, then scan four digits from [Numeric Bar Codes on page D-1](#) that specify the timeout in milliseconds. For example, to enter 400 msec, scan the following bar code, then scan 0400. The range is 0 to 5000 msec, and the default is 200 msec.



PDF Prioritization Timeout

Continuous Bar Code Read

Parameter # 649

Enable this to report every bar code while the trigger is pressed.

- ✓ **NOTE** Zebra strongly recommends enabling [Picklist Mode on page 5-28](#) with this feature. Disabling Picklist Mode can cause accidental decodes when more than one bar code is in the imaging engine's field of view.



*Disable Continuous Bar Code Read
(0)



Enable Continuous Bar Code Read
(1)

Unique Bar Code Reporting

Parameter # 723

Enable this to report only unique bar codes while the trigger is pressed. This option only applies when **Continuous Bar Code Read** is enabled.



*Disable Continuous Bar Code Read Uniqueness
(0)



Enable Continuous Bar Code Read Uniqueness
(1)

Decode Session Timeout

Parameter # 136

This parameter sets the maximum time decode processing continues during a scan attempt. It is programmable in 0.1 second increments from 0.5 to 9.9 seconds. The default timeout is 9.9 seconds.

To set a Decode Session Timeout, scan the bar code below. Next, scan two numeric bar codes from [Appendix D, Numeric Bar Codes](#) that correspond to the desired on time. Enter a leading zero for single digit numbers. For example, to set a Decode Session Timeout of 0.5 seconds, scan the bar code below, then scan the **0** and **5** bar codes. To correct an error or change the selection, scan **Cancel** on [page D-2](#).



Decode Session Timeout

Timeout Between Decodes, Same Symbol

Parameter # 137

Use this option in presentation mode and Continuous Bar Code Read to prevent the beeper from continuously beeping when a symbol is left in the digital scanner's field of view. The bar code must be out of the field of view for the timeout period before the digital scanner reads the same consecutive symbol. It is programmable in 0.1 second increments from 0.0 to 9.9 seconds. The default interval is 0.5 seconds.

To select the timeout between decodes for the same symbol, scan the bar code below, then scan two numeric bar codes from [Appendix D, Numeric Bar Codes](#) that correspond to the desired interval, in 0.1 second increments.



Timeout Between Decodes, Same Symbol

Timeout Between Decodes, Different Symbols

Parameter # 144

Use this option in presentation mode and Continuous Bar Code Read to control the time the scanner is inactive between decoding different symbols. It is programmable in 0.1 second increments from 0.1 to 9.9 seconds. The default is 0.2 seconds.

To select the timeout between decodes for different symbols, scan the bar code below, then scan two numeric bar codes from [Appendix D, Numeric Bar Codes](#) that correspond to the desired interval, in 0.1 second increments.



Timeout Between Decodes, Different Symbols

Fuzzy 1D Processing

Parameter # 514

This option is enabled by default to optimize decode performance on 1D bar codes, including damaged and poor quality symbols. Disable this only if you experience time delays when decoding 2D bar codes, or in detecting a no decode.



*Enable Fuzzy 1D Processing
(1)



Disable Fuzzy 1D Processing
(0)

Hand-held Decode Aiming Pattern

Parameter # 306

Select **Enable Hand-held Decode Aiming Pattern** to project the aiming pattern during bar code capture, **Disable Hand-held Decode Aiming Pattern** to turn the aiming pattern off, or **Enable Hand-held Decode Aiming Pattern on PDF** to project the aiming pattern when the digital scanner detects a 2D bar code.



NOTE With [Picklist Mode on page 5-28](#) enabled, the decode aiming pattern flashes even when the **hand-held Decode Aiming Pattern** is disabled.



*Enable Hand-held Decode Aiming Pattern
(2)



Disable Hand-held Decode Aiming Pattern
(0)



Enable Hand-held Decode Aiming Pattern on PDF
(3)

Hands-free Decode Aiming Pattern

Parameter # 590

Select **Enable Hands-free Decode Aiming Pattern** to project the aiming pattern during bar code capture, **Disable Hands-free Decode Aiming Pattern** to turn the aiming pattern off, or **Enable Hands-free Decode Aiming Pattern on PDF** to project the aiming pattern when the digital scanner detects a 2D bar code. This parameter does not apply to Snapshot Mode. See [Modes of Operation on page 5-15](#).

✓ **NOTE** With [Picklist Mode on page 5-28](#) enabled, the decode aiming pattern flashes even when the **Decode Aiming Pattern** is disabled.



Enable Hands-free Decode Aiming Pattern
(1)



Disable Hands-free Decode Aiming Pattern
(0)



*Enable Hands-free Decode Aiming Pattern on PDF
(2)

Presentation Mode Field of View

Parameter # 609

In presentation mode, by default the digital scanner searches the larger area of the aiming pattern (**Full Field of View**).

To search for a bar code in a smaller region around the aiming pattern's center cross in order to speed search time, select **Small Field of View** or **Medium Field of View**.

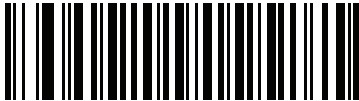

**Small Field of View
(0)**



**Medium Field of View
(1)**



***Full Field of View
(2)**

Decoding Illumination

Parameter # 298

Selecting **Enable Decoding Illumination** causes the digital scanner to flash illumination to aid decoding. Select **Disable Decoding Illumination** to prevent the digital scanner from using decoding illumination.

Enabling illumination usually results in superior images. The effectiveness of the illumination decreases as the distance to the target increases.



*Enable Decoding Illumination
(1)



Disable Decoding Illumination
(0)

Multicode Mode

Parameter # 677

Enable this parameter to allow multiple bar codes to decode upon one trigger event based on the programmed multicode expression. The digital scanner reports a successful decode and provides user indication only if it decodes all bar codes indicated by the multicode expression, otherwise the decode fails. Bar codes are transmitted in the order defined in the multicode expression. Disable this to operate in normal decode mode.

When using this mode, disable [Continuous Bar Code Read on page 5-32](#), and always orient the digital scanner at the same distance and angle (perpendicular).



*Disable Multicode Mode
(0)



Enable Multicode Mode
(1)

Multicode Expression

Parameter # 661

Use this feature to program a multicode expression for *Multicode Mode* (grid method). The default is 1, which indicates any bar code.

To set the multicode expression:

1. Scan the bar code below.
2. Scan bar codes from the alphanumeric keyboard in *Chapter 16, Advanced Data Formatting* to define the expression.
3. Scan the **End of Message** bar code from *Chapter 16, Advanced Data Formatting*.

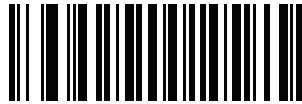

Multicode Expression

Multicode Expression Syntax

[n] [Element 1]; [Element 2]; ... [Element n];

Where:

n is the number of elements in the overall expression.

The multicode expression describes the bar code(s) that the digital scanner can expect to find in an image. Each element represents one bar code in the digital scanner's field of view. The order of elements in the expression is the order in which bar code data from each element transmits to the host. Elements are defined using one or more of the following methods:

- **By Region.** This type of element limits decoding to a specific area within the digital scanner's field of view. Region coordinates are defined as the top left and bottom right corners of the region, expressed in percentages of the field of view. These can range from 0% to 100%, or 0x00 to 0x64 in hex, for both horizontal and vertical axes. A region element is constructed as:

[R] [4] [Top, Left] [Bottom, Right]

Where:

- [R] is the character R
- [4] is 0x04, indicating there are four bytes thereafter to describe the region
- [Top, Left] are two values representing the top left corner of the region
- [Bottom, Right] are two values representing the bottom right corner of the region
- **By Code Type.** An element can specify a specific bar code symbology to find and decode somewhere in the field of view. A code type element is constructed as:

[C] [2] [Code Type]

Where:

- [C] is the character C
- [2] is 0x02, indicating there are two bytes thereafter to describe the code type
- [Code Type] is the desired symbology's parameter number (see *Chapter 15, Symbologies*). For single-byte parameter numbers, extend the value to two bytes by adding 00 before the parameter number.

Defining Multicode Expression Notes

When defining multicode expressions consider the following:

- Use the Code Type specifier if there are bar codes of more than one code type in view.
- Always use the Region specifier when there are multiple bar codes of the same code type.
- When transmission order is important (the first element in the expression transmits first), use either type to define the order.
- When there are unwanted bar codes in view, filter them out in one of two ways:
 - Use Code Type to specify only the target bar codes.
 - Use Region to identify only the target bar codes.
- If the expression does not contain a Region specifier, scanning angle and distance do not matter. If you specify a region you must scan in a fixed orientation and at a fixed distance. Because of this, it is preferable to use the Code Type specifier rather than the Region specifier.
- When defining regions:
 - Defining a region much larger than the bar code improves tolerance to scan distance and angle, but can cause a decode of a nearby bar code instead of the target bar code. Therefore, for best performance define larger regions when only a few bar codes are in view and those in view are widely separated.
 - Defining a region close to (or smaller than) the target bar code improves the probability of decoding this bar code rather than one nearby, but scan distance and angle must be more accurate. Therefore, for best performance define small regions when many bar codes are in view or those in view are close together.
- Use Region elements to improve decode speeds by reducing the image area to search for the target bar code.
- Specifying Code Type may also improve decode speeds for some code types.
- Although you can scan parameter bar codes when multicode mode is enabled, be aware of the following: If the multicode expression defined a region(s), to scan a parameter bar code you must position the bar code within the first region defined in the expression. In some cases, this first region is not the center of the image and aiming at the parameter bar code does not result in a successful decode.

The following examples show the multicode expressions in both hex and decimal formats, however in the sample figures the values are decimal. Be sure to use the correct base numbering system when creating an expression. A region specified as 0x00 0x00 0x64 0x32 represents a region with coordinates of Top-Left (0,0) and Bottom Right (100,50).

Example 1

To decode one Code 128 bar code anywhere in the image (even when bar codes of other types are in view), as in [Figure 5-2](#), program the expression as follows:

The expression in decimal is (formatted for readability):

```
1 C 2 0 8 ;
```

To program the expression via scanning parameters the sequence is (spaces are for readability):

```
[MultiCode-Expression] 01 C 02 00 08 ; [End Of Message]
```

To program the expression via host command (SSI/SNAPI) the sequence is:

```
0x01 0x43 0x02 0x00 0x08 0x3b
```

✓ **NOTE** The CR0078-S cradle supports SSI. The CR0078-P cradle supports SNAPI.

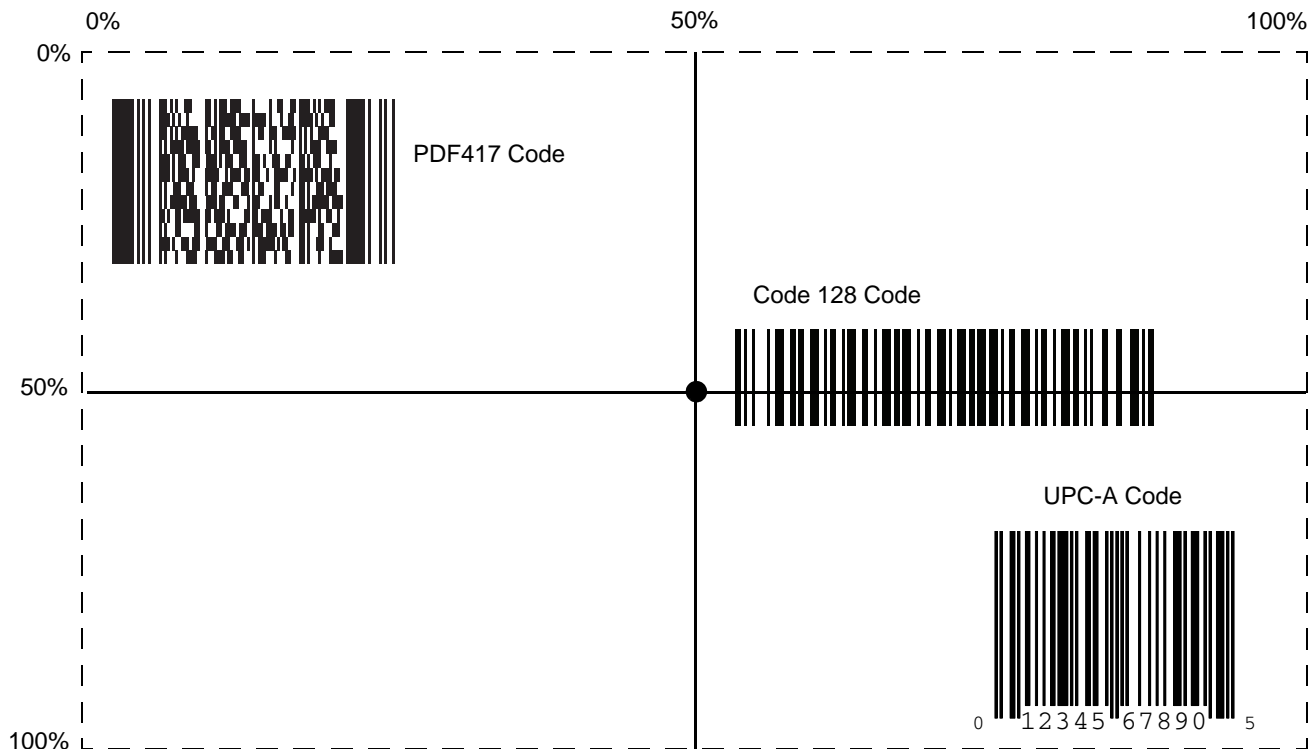

Figure 5-2 Multicode Expression Example 1

Example 2a

To decode a Code128 (Code Type=8) on the top half of the image and a PDF417 (Code Type=15) on the bottom half of the image, as in [Figure 5-3](#), program the expression as follows:

The expression in decimal is (formatted for readability):

```
2 C 2 0 8 R 4 0 0 100 50 ; C 2 0 15 R 4 0 50 100 100 ;
```

To program the expression via scanning parameters the sequence is:

```
[MultiCode-Expression] 02 C 02 00 08 R 04 00 00 64 32 ; C 02 00 0F R 04 00 32 64 64 ; [End Of Message]
```

To program the expression via host command (SSI/SNAPI) the sequence is:

```
0x02 0x43 0x02 0x00 0x08 0x52 0x04 0x00 0x00 0x64 0x32 0x3B 0x43 0x02 0x00 0x0F 0x52 0x04 0x00 0x32 0x64 0x64 0x3B
```

NOTE The CR0078-S cradle supports SSI. The CR0078-P cradle supports SNAPI.

Example 2b

In [Figure 5-3](#), if the bottom PDF417 bar code must transmit first, reverse the sequence of the two bar codes:

The expression in decimal is (formatted for readability):

```
2 C 2 0 15 R 4 0 50 100 100 ; C 2 0 8 R 4 0 0 100 50 ;
```

To program the expression via scanning parameters the sequence is:

```
[MultiCode-Expression] 02 C 02 00 0F R 04 00 32 64 64 ; C 02 00 08 R 04 00 00 64 32 ; [End Of Message]
```

To program the expression via host command (SSI/SNAPI) the sequence is:

```
0x02 0x43 0x02 0x00 0x0F 0x52 0x04 0x00 0x32 0x64 0x64 0x3B 0x43 0x02 0x00 0x08 0x52 0x04 0x00 0x00 0x64 0x32 0x3B
```

NOTE The CR0078-S cradle supports SSI. The CR0078-P cradle supports SNAPI.

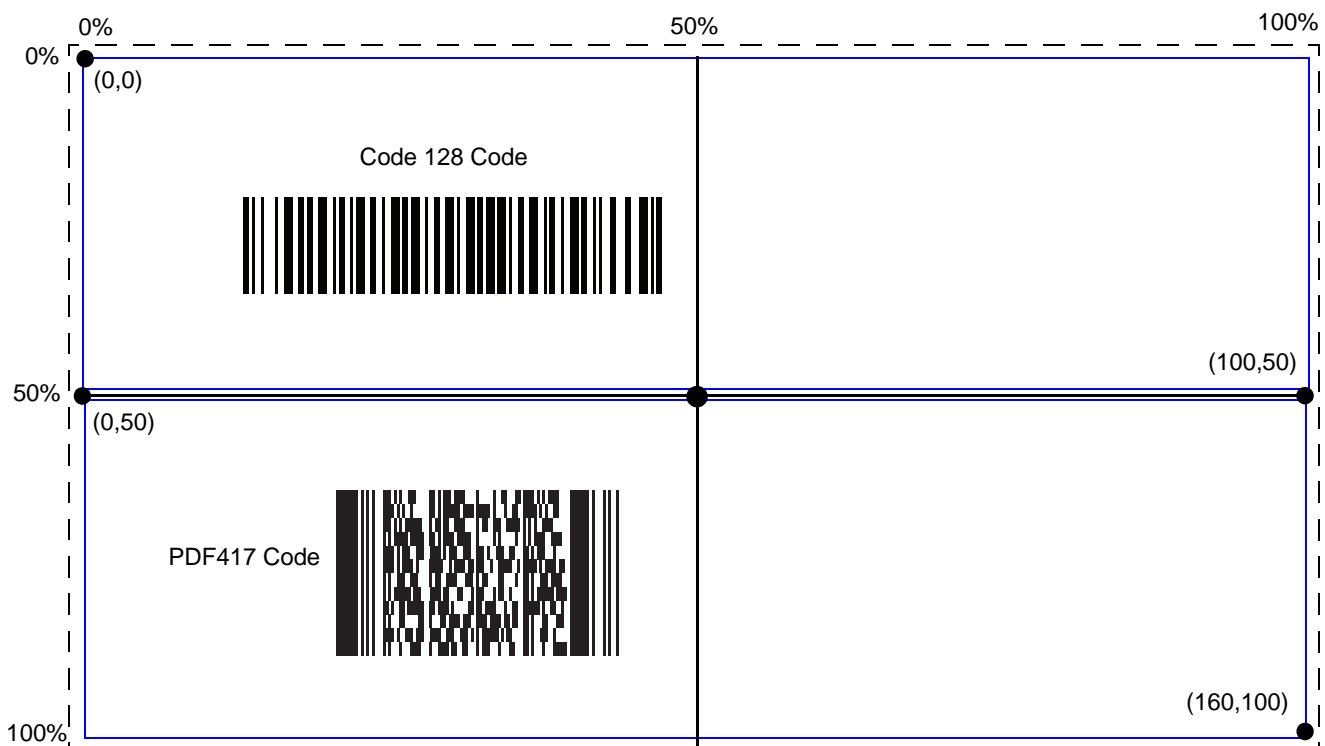

Figure 5-3 Multicode Expression Example 2

Example 3

To decode the set of three bar codes while excluding the center Code 128 bar code, as in *Figure 5-4*, the expression is:

The expression in decimal is (formatted for readability):

```
3 C 2 0 15 R 4 0 0 50 50 ; C 2 [F0 24] R 4 70 0 100 40 ; C 2 0 8 R 4 65 60 100 100 ;
```

To program the expression via scanning parameters the sequence is:

```
[MultiCode-Expression] 03 C 02 00 0F R 04 00 00 32 32 ; C 02 F0 24 R 04 46 00 64 28 ;  
C 02 00 08 R 04 41 3C 64 64 ; [End Of Message]
```

To program the expression via host command (SSI/SNAPI) the sequence is:

```
0x03 0x43 0x02 0x00 0x0F 0x52 0x04 0x00 0x00 0x32 0x32 0x3B 0x43 0x02 0xF0 0x24 0x52 0x04 0x46  
0x00 0x64 0x28 0x3B 0x43 0x02 0x00 0x08 0x52 0x04 0x41 0x3C 0x64 0x64 0x3B
```

✓ **NOTE** The CR0078-S cradle supports SSI. The CR0078-P cradle supports SNAPI.

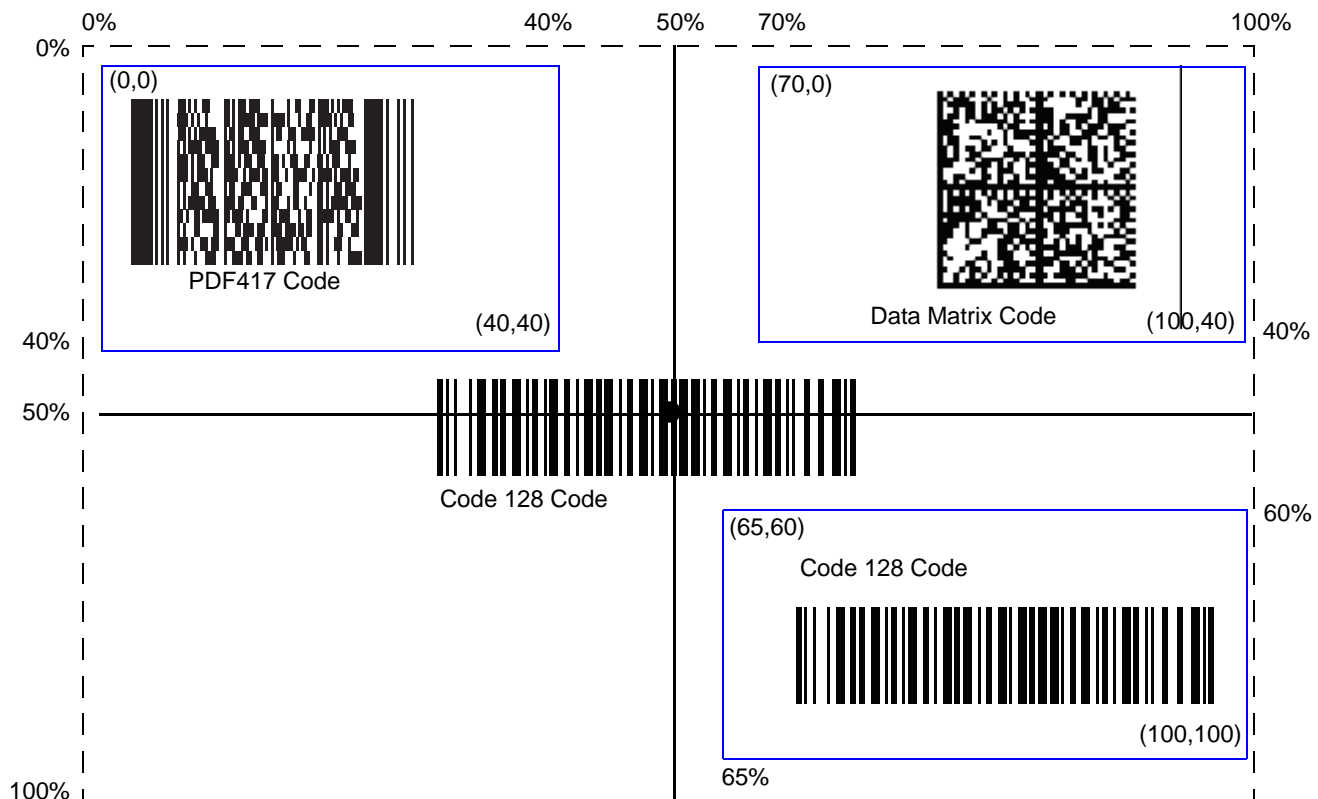

Figure 5-4 Multicode Expression Example 3

Multicode Mode Concatenation

Parameter # 717

Enable this parameter to transmit multiple decoded bar codes, as specified by the *Multicode Expression*, as one bar code. Use the *Multicode Concatenation Symbology* parameter to specify how the concatenated bar codes transmit.

Disable this to transmit decoded bar codes separately.

✓ **NOTE** When using Multicode Mode Concatenation, disable *Transmit Code ID Character on page 5-47* and check digits.



Enable Multicode Mode Concatenation
(1)



*Disable Multicode Mode Concatenation
(0)

Multicode Concatenation Symbology

Parameter # 722

Use this parameter to specify how to transmit the concatenated bar codes decoded as specified by the *Multicode Expression*. *Multicode Mode Concatenation* must be enabled to use this option.



Concatenation as Code 128
(1)



* Concatenation as PDF417
(2)



Concatenation as Data Matrix
(3)



Concatenation as Maxicode
(4)

Multicode Troubleshooting

Troubleshooting Multicode Expression Programming

Use the following suggestions if encountering problems programming a multicode expression:

- Ensure the expression is valid. Invalid expressions are rejected during programming. When an expression is rejected the previous expression remains intact. If after programming the expression the digital scanner can still decode any bar code, the expression was possibly rejected.
- When programming the multicode expression via parameter bar code, the digital scanner generates beeps. If any of the following beeps do not sound during programming, an error occurred (see [Table 2-1 on page 2-1](#) and [Table 2-2 on page 2-3](#) for error indicators):
 - Scanning the **Multicode Expression** bar code produces a two-tone (same pitch) beep.
 - Scanning each value of the expression produces a two-tone (same pitch) beep.
 - Scanning the **End Of Message** bar code produces a four-tone (high-low-high-low) beep.
- Check the expression for syntax errors.
- Try programming a simple expression to ensure the syntax is correct. See [Examples of Simple Multicode Expressions](#).
- Review [Defining Multicode Expression Notes on page 5-39](#) for additional hints.

Troubleshooting Multicode Mode Scanning and Decoding

Use the following suggestions if encountering problems using multicode mode:

- If the digital scanner appears to decode any single bar code instead of the intended multiple bar codes, ensure you enabled [Multicode Mode on page 5-37](#). Programming the multicode expression does not enable multicode mode.
- When specifying **Region**, ensure:
 - Coordinates are within range the 0-100 decimal (or 0x00 - 0x64 hexadecimal).
 - Top, Left is above Bottom, Right. Top, Left is 0,0 (0x00, 0x00 hexadecimal), and Bottom, Right is 100,100 (0x64, 0x64 hexadecimal).
 - Regions for two or more bar codes do not overlap.
- When specifying **Code Type** ensure the digital scanner supports the code type. Try decoding a single bar code without using multicode. If it does not decode try enabling the bar code type. See [Chapter 15, Symbolologies](#).
- Experiment with simpler expressions, then add to it until you discover the source of the error. For example try the simplest expression (see [Examples of Simple Multicode Expressions](#)) and make sure you can scan a single bar code. If so, extend the expression by adding a second bar code, specifying a region, or specifying the code type. Verify that the digital scanner can decode this new expression. Continue adding to the expression until it fails to decode as expected, indicating the source of the error.
- Review [Defining Multicode Expression Notes on page 5-39](#) for additional hints.

Examples of Simple Multicode Expressions

The simplest multicode expression is:

- One bar code of any type, anywhere in the image.
- To program this use: **[MultiCode-Expression] 01 ; [End Of Message]**

Another simple multicode expression is:

- One Code 128 bar code, anywhere in the image.
- To program this use: **[MultiCode-Expression] 01 C 02 00 08 ; [End Of Message]**

Miscellaneous Scanner Parameters

Transmit Code ID Character

Parameter # 45

A Code ID character identifies the code type of a scanned bar code. This is useful when decoding more than one code type. In addition to any single character prefix already selected, the Code ID character is inserted between the prefix and the decoded symbol.

Select no Code ID character, a Symbol Code ID character, or an AIM Code ID character. For Code ID Characters, see [Symbol Code Characters on page B-1](#) and [AIM Code Identifiers on page B-3](#).

✓ **NOTE** If you enable Symbol Code ID Character or AIM Code ID Character, and enable [Transmit "No Read" Message on page 5-51](#), the digital scanner appends the code ID for Code 39 to the NR message.

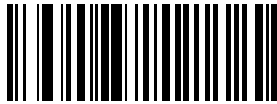

Symbol Code ID Character
(2)

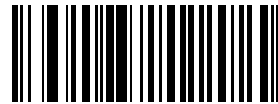

AIM Code ID Character
(1)

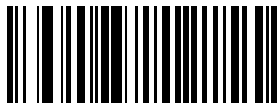

*None
(0)

Prefix/Suffix Values

Key Category Parameter # P = 99, S1 = 98, S2 = 100

Decimal Value Parameter # P = 105, S1 = 104, S2 = 106

You can append a prefix and/or one or two suffixes to scan data for use in data editing. To set a value for a prefix or suffix, scan a four-digit number (i.e., four bar codes from [Appendix D, Numeric Bar Codes](#)) that corresponds to that value. See [Table E on page E-1](#) for the four-digit codes.

When using host commands to set the prefix or suffix, set the key category parameter to 1, then set the 3-digit decimal value. See [Table E on page E-1](#) for the four-digit codes.

To correct an error or change a selection, scan [Cancel on page D-2](#).

✓ **NOTE** To use Prefix/Suffix values, first set the [Scan Data Transmission Format on page 5-49](#).

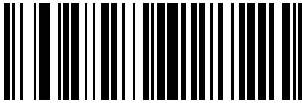

Scan Prefix
(7)



Scan Suffix 1
(6)



Scan Suffix 2
(8)



Data Format Cancel

Scan Data Transmission Format

Parameter # 235

To change the scan data format, scan one of the following eight bar codes corresponding to the desired format.

✓ **NOTE** If using this parameter do not use ADF rules to set the prefix/suffix.

To set values for the prefix and/or suffix, see [Prefix/Suffix Values on page 5-48](#).



*Data As Is
(0)



<DATA> <SUFFIX 1>
(1)



<DATA> <SUFFIX 2>
(2)



<DATA> <SUFFIX 1> <SUFFIX 2>
(3)



<PREFIX> <DATA >
(4)

Scan Data Transmission Format (continued)



<PREFIX> <DATA> <SUFFIX 1>
(5)



<PREFIX> <DATA> <SUFFIX 2>
(6)



<PREFIX> <DATA> <SUFFIX 1> <SUFFIX 2>
(7)

FN1 Substitution Values

Key Category Parameter # 103

Decimal Value Parameter # 109

The Wedge and USB Keyboard (HID) hosts support a FN1 Substitution feature. Enabling this substitutes any FN1 character (0x1b) in an EAN128 bar code with a value. This value defaults to 7013 (Enter Key).

When using host commands to set the FN1 substitution value, set the key category parameter to 1, then set the 3-digit keystroke value. See the ASCII Character Set table for the current host interface for the desired value.

To select a FN1 substitution value via bar code menus:

1. Scan the bar code below.

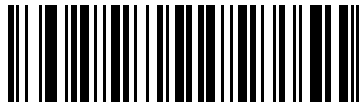

Set FN1 Substitution Value

2. Locate the keystroke desired for FN1 Substitution in the ASCII Character Set table for the current host interface. Enter the 4-digit ASCII Value by scanning each digit in [Appendix D, Numeric Bar Codes](#).

To correct an error or change the selection, scan **Cancel**.

To enable FN1 substitution for USB Keyboard (HID), scan the **Enable FN1 Substitution** bar code on page [5-50](#).

Transmit "No Read" Message

Parameter # 94

Scan a bar code below to select whether or not to transmit a No Read message. Enable this to transmit the characters NR when a successful decode does not occur before trigger release or the **Decode Session Timeout** expires. See [Decode Session Timeout on page 5-33](#). Disable this to send nothing to the host if a symbol does not decode.



NOTE If you enable **Transmit No Read**, and also enable Symbol Code ID Character or AIM Code ID Character for [Transmit Code ID Character on page 5-47](#), the digital scanner appends the code ID for Code 39 to the NR message.



Enable No Read
(1)



*Disable No Read
(0)

Unsolicited Heartbeat Interval

Parameter # 1118

The digital scanner supports sending *Unsolicited Heartbeat Messages* to assist in diagnostics. To enable this feature and set the desired unsolicited heartbeat interval, scan one of the time interval bar codes below, or scan **Set Another Interval** followed by four numeric bar codes from [Appendix D, Numeric Bar Codes](#) (scan sequential numbers that correspond to the desired number of seconds).

Scan **Disable Unsolicited Heartbeat Interval** to turn off the feature.

The heartbeat event is sent as decode data (with no decode beep) in the form of:

MOTEVTHB:nnn

where *nnn* is a three-digit sequence number starting at 001 and wrapping after 100.

✓ **NOTE** For proper operation, disable [Low Power Mode on page 5-20](#).

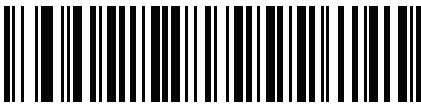

10 seconds
(10)



1 minute
(60)



Set Another Interval



* Disable Unsolicited Heartbeat Interval
(0)

Dump Scanner Parameters

To debug scanner issues, scan the bar code below to output all the scanner's asset tracking information and parameter settings. This outputs information a text document in human readable format.

Scan **Dump Scanner Parameters** with the scanner connected in USB HID keyboard mode to Microsoft® Windows Notepad or Wordpad, or with the scanner connected via RS232 to a Windows hyperterminal. Use the parameter numbers in this guide or the Attribute Data Dictionary (index of parameters) to interpret the parameter/attribute numbers in this output. The Attribute Data Dictionary (72E-149786-xx) is located on the Support site at: <http://www.zebra.com/support>.



NOTE It may be necessary to first scan <DATA><SUFFIX1> for proper formatting. See [Scan Data Transmission Format on page 5-49](#).

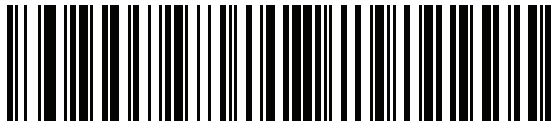

Dump Scanner Parameters

Report Version

Scan the bar code below to report the version of software currently installed in the imager.



Report Software Version

CHAPTER 6 IMAGING PREFERENCES

Introduction

You can program the digital scanner to perform various functions, or activate different features. This chapter describes imaging preference features and provides programming bar codes for selecting these features.

✓ **NOTE** Only the Symbol Native API (SNAPI) with Imaging interface supports image capture. See [USB Device Type on page 7-5](#) to enable this host.

The digital scanner ships with the settings in [Imaging Preferences Default Parameters on page 6-2](#) (also see [Appendix A, Standard Default Parameters](#) for all host device and miscellaneous defaults). If the default values suit requirements, programming is not necessary.

To set feature values, scan a single bar code or a short bar code sequence. The settings are stored in non-volatile memory and are preserved even when you power down the digital scanner.

✓ **NOTE** Most computer monitors allow scanning the bar codes directly on the screen. When scanning from the screen, be sure to set the document magnification to a level where you can see the bar code clearly, and bars and/or spaces are not merging.

If not using a USB cable, select a host type after the power-up beeps sound. See [Chapter 7, USB Interface](#) and [Chapter 8, RS-232 Interface](#) for specific host information. This is only necessary upon the first power-up when connecting to a new host.

To return all features to default values, scan the [Default Parameters on page 5-5](#). Throughout the programming bar code menus, asterisks (*) indicate default values.

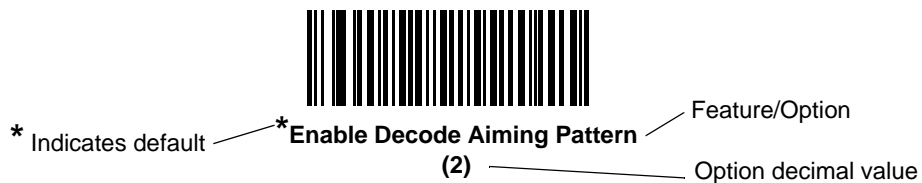

Scanning Sequence Examples

In most cases scanning one bar code sets the parameter value. For example, to disable image capture illumination, scan the **Disable Image Capture Illumination** bar code under *Image Capture Illumination on page 6-5*. The digital scanner issues a fast warble beep and the LED turns green, signifying a successful parameter entry.

Other parameters require scanning several bar codes. See these parameter descriptions for this procedure.

Errors While Scanning

Unless otherwise specified, to correct an error during a scanning sequence, just re-scan the correct parameter.

Imaging Preferences Parameter Defaults

Table 6-1 lists the defaults for imaging preferences parameters. To change the default values, scan the appropriate bar codes in this guide. These new values replace the standard default values in memory. To recall the default parameter values, scan the *Default Parameters on page 5-5*.

✓ **NOTE** See *Appendix A, Standard Default Parameters* for all user preferences, hosts, symbologies, and miscellaneous default parameters.

Table 6-1 *Imaging Preferences Default Parameters*

Parameter	Parameter Number	Default	Page Number
Imaging Preferences			
Operational Modes	N/A	N/A	6-4
Image Capture Illumination	361	Enable	6-5
Gain / Exposure Priority for Snapshot Mode	562	Autodetect	6-6
Snapshot Mode Timeout	323	0 (30 seconds)	6-7
Snapshot Aiming Pattern	300	Enable	6-7
Image Cropping	301	Disable	6-7
Crop to Pixel Addresses	315 316 317 318	0 top 0 left 479 bottom 751 right	6-8
Image Size (Number of Pixels)	302	Full	6-9
Image Brightness (Target White)	390	180	6-10
JPEG Image Options	299	Quality	6-10
JPEG Target File Size	561	160 kB	6-11

Table 6-1 *Imaging Preferences Default Parameters (Continued)*

Parameter	Parameter Number	Default	Page Number
JPEG Quality and Size Value	305	65	6-11
Image Enhancement	564	Off (0)	6-12
Image File Format Selection	304	JPEG	6-13
Image Rotation	665	0	6-14
Bits per Pixel (BPP)	303	8 BPP	6-15
Signature Capture	93	Disable	6-16
Signature Capture Image File Format Selection	313	JPEG	6-17
Signature Capture Bits per Pixel (BPP)	314	8 BPP	6-18
Signature Capture Width	366	400	6-19
Signature Capture Height	367	100	6-19
Signature Capture JPEG Quality	421	65	6-19

Imaging Preferences

The parameters in this chapter control image capture characteristics. Image capture occurs in all modes of operation, including decode and snapshot.

Operational Modes

The digital scanner has two modes of operation:

- Decode Mode
- Snapshot Mode.

Decode Mode

By default, when you pull the trigger the digital scanner attempts to locate and decode enabled bar codes within its field of view. The digital scanner remains in this mode until it decodes a bar code or you release the trigger.

Snapshot Mode

Use Snapshot Mode to capture a high-quality image and transmit it to the host. To temporarily enter this mode scan the **Snapshot Mode** bar code. While in this mode the digital scanner blinks the green LED at 1-second intervals to indicate it is not in standard operating (decode) mode.

In Snapshot Mode, the digital scanner turns on its laser aiming pattern to highlight the area to capture in the image. The next trigger pull instructs the digital scanner to capture a high quality image and transmit it to the host. A short time may pass (less than 2 seconds) between when the trigger is pulled and the image is captured as the digital scanner adjusts to the lighting conditions. Hold the digital scanner steady until the image is captured, denoted by a single beep.

If you do not press the trigger within the Snapshot Mode Timeout period, the digital scanner returns to Decode Mode. Use [Snapshot Mode Timeout on page 6-7](#) to adjust this timeout period. The default timeout period is 30 seconds.

To disable the laser aiming pattern during Snapshot Mode, see [Snapshot Aiming Pattern on page 6-7](#).



Snapshot Mode

Image Capture Illumination

Parameter # 361

Selecting **Enable Image Capture Illumination** causes illumination to turn on during every image capture. Disable illumination to prevent the digital scanner from using illumination.

Enabling illumination usually results in superior images. The effectiveness of illumination decreases as the distance to the target increases.

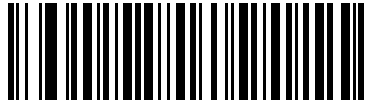

***Enable Image Capture Illumination**
(1)



Disable Image Capture Illumination
(0)

Gain/Exposure Priority for Snapshot Mode

Parameter # 562

This parameter alters the digital scanner's gain exposure priority when it acquires an image in Snapshot Mode in auto exposure mode.

- Scan **Low Exposure Priority** to set a mode in which the digital scanner favors higher gain over exposure to capture an image. This results in an image that is less susceptible to motion blur at the expense of noise artifacts. However, for most applications, the amount of noise is acceptable.
- Scan **Low Gain Priority** to set a mode in which the digital scanner favors longer exposure time rather than higher gain to capture an image. This ensures that the image is less noisy and produces fewer artifacts during post processing activities like image enhancement (sharpening). The mode is recommended for fixed mount / fixed object image capture since the image acquired is susceptible to motion blur.
- Scan **Autodetect** (default) to set a mode in which the digital scanner automatically selects Gain Priority or Low Exposure Priority mode for Snapshot Mode. If the digital scanner is in a magnetic read switch enabled stand (or it is configured in Blink Mode), it uses Low Gain Priority mode. Otherwise, it uses the Low Exposure Priority mode.



Low Gain Priority
(0)



Low Exposure Priority
(1)



* Autodetect
(2)

Snapshot Mode Timeout

Parameter # 323

This parameter sets the amount of time the digital scanner remains in Snapshot Mode. The digital scanner exits Snapshot Mode when you pull the trigger, or when the Snapshot Mode Timeout elapses. To set this timeout value, scan the bar code below followed by a bar code from [Appendix D, Numeric Bar Codes](#). The default value is 0 which represents 30 seconds; values increment by 30. For example, 1 = 60 seconds, 2 = 90 seconds, etc.



Snapshot Mode Timeout

Snapshot Aiming Pattern

Parameter # 300

Select **Enable Snapshot Aiming Pattern** to project the aiming pattern when in Snapshot Mode, or **Disable Snapshot Aiming Pattern** to turn the aiming pattern off.



*Enable Snapshot Aiming Pattern
(1)



Disable Snapshot Aiming Pattern
(0)

Image Cropping

Parameter # 301

This parameter crops a captured image. Select **Disable Image Cropping** to present the full 752 x 480 pixels. Select **Enable Image Cropping** to crop the image to the pixel addresses set in [Crop to Pixel Addresses on page 6-8](#).



Enable Image Cropping
(1)



*Disable Image Cropping
(Use Full 752 x 480 Pixels)
(0)

Crop to Pixel Addresses

Parameter # 315 (Top)

Parameter # 316 (Left)

Parameter # 317 (Bottom)

Parameter # 318 (Right)

If you selected **Enable Image Cropping**, set the pixel addresses from (0,0) to (751,479) to crop to.

Columns are numbered from 0 to 751, rows from 0 to 479. Specify four values for Top, Left, Bottom, and Right, where Top and Bottom correspond to row pixel addresses, and Left and Right correspond to column pixel addresses. For example, for a 4 row x 8 column image in the extreme bottom-right section of the image set the following values:

Top = 476, Bottom = 479, Left = 744, Right = 751

To set the crop to pixel address, scan each pixel address bar code below followed by three numeric bar codes representing the value. Leading zeros are required. For example, to crop the top pixel address to 3, scan 0, 0, 3. See [Appendix D, Numeric Bar Codes](#) for numeric bar codes.

✓ **NOTE** The digital scanner has a cropping resolution of 4 pixels. Setting the cropping area to less than 4 pixels (after resolution adjustment, see [Image Size \(Number of Pixels\) on page 6-9](#)) transfers the entire image.

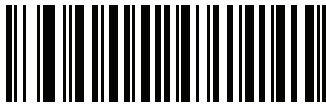

Top Pixel Address
(0 - 479 Decimal)

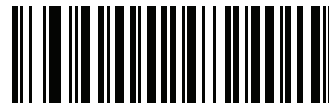

Left Pixel Address
(0 - 751 Decimal)



Bottom Pixel Address
(0 - 479 Decimal)



Right Pixel Address
(0 - 751 Decimal)

Image Size (Number of Pixels)

Parameter # 302

This option alters image resolution before compression. Multiple pixels are combined to one pixel, resulting in a smaller image containing the original content with reduced resolution.

Select one of the following values:

Resolution Value	Uncropped Image Size
Full	752 x 480
1/2	376 x 240
1/4	180 x 120



* Full Resolution
(0)



1/2 Resolution
(1)



1/4 Resolution
(3)

Image Brightness (Target White)

Parameter # 390

Type: Byte

Range: 1 - 240

This parameter sets the Target White value used in Snapshot and Video Viewfinder mode when using auto exposure. White and black are defined as 240 decimal and 1, respectively. Setting the value to the factory default of 180 sets the white level of the image to ~180.

To set the Image Brightness parameter, scan **Image Brightness** below followed by three numeric bar codes representing the value. Leading zeros are required. For example, to set an Image Brightness value of 99, scan 0, 9, 9. See [Appendix , Numeric Bar Codes](#) for numeric bar codes.



JPEG Image Options

Parameter # 299

Select an option to optimize JPEG images for either size or for quality. Scan the **JPEG Quality Selector** bar code to enter a quality value; the digital scanner then selects the corresponding image size. Scan the **JPEG Size Selector** bar code to enter a size value; the digital scanner then selects the best image quality.



JPEG Target File Size

Parameter # 561

Type: Word

Range: 5-350

This parameter defines the target JPEG file size in terms 1 Kilobytes (1024 bytes). The default value is 160 kB which represents 160 Kilobytes.



CAUTION JPEG compress may take 10 to 15 seconds based on the amount of information in the target image. Scanning **JPEG Quality Selector** (default setting) on [page 6-10](#) produces a compressed image that is consistent in quality and compression time.

To set the JPEG Target File Size parameter, scan **JPEG Target File Size** below followed by three numeric bar codes representing the value. Leading zeros are required. For example, to set a JPEG target file size value of 99, scan 0, 9, 9 in [Appendix D, Numeric Bar Codes](#).



JPEG Target File Size
(3 digits)

JPEG Quality and Size Value

JPEG Quality = Parameter # 305

If you selected **JPEG Quality Selector**, scan the **JPEG Quality Value** bar code followed by 3 bar codes from [Appendix D, Numeric Bar Codes](#) corresponding to a value from 5 to 100, where 100 represents the highest quality image.



JPEG Quality Value
(Default: 065)
(5 - 100 Decimal)

Image Enhancement

Parameter # 564

This parameter configures the digital scanner's Image Enhance feature. This feature uses a combination of edge sharpening and contrast enhancement to produce an image that is visually pleasing.

The levels of image enhancement are:

- Off (0) - Default
- Low (1)
- Med (2)
- High (3).



***Off
(0)**



**Low
(1)**



**Medium
(2)**



**High
(3)**

Image File Format Selector

Parameter # 304

Select an image format appropriate for the system (BMP, TIFF, or JPEG). The digital scanner stores captured images in the selected format.



BMP File Format
(3)



*** JPEG File Format**
(1)



TIFF File Format
(4)

Image Rotation

Parameter # 665

This parameter controls the rotation of the image by 0, 90,180, or 270 degrees.



***Rotate 0°
(0)**



**Rotate 90°
(1)**



**Rotate 180°
(2)**



**Rotate 270°
(3)**

Bits Per Pixel

Parameter # 303

Select the number of significant bits per pixel (BPP) to use when capturing an image. Select **1 BPP** for a black and white image, **4 BPP** to assign 1 of 16 levels of grey to each pixel, or **8 BPP** to assign 1 of 256 levels of grey to each pixel.

✓ **NOTE** The digital scanner ignores these settings for JPEG file formats, which only support **8 BPP**.

The digital scanner ignores 1 BPP for TIFF file formats, which only support **4 BPP** and **8 BPP**. 1 BPP is coerced to 4 BPP for TIFF file formats.



1 BPP
(0)



4 BPP
(1)



*8 BPP
(2)

Signature Capture

Parameter # 93

A signature capture bar code is a special-purpose symbology which delineates a signature capture area in a document with a machine-readable format. The recognition pattern is variable so it can optionally provide an index to various signatures. The region inside the bar code pattern is considered the signature capture area. See [Appendix H, Signature Capture Code](#) for more information.

Output File Format

Decoding a signature capture bar code de-skews the signature image and converts the image to a BMP, JPEG, or TIFF file format. The output data includes the file descriptor followed by the formatted signature image.

File Descriptor			Signature Image
Output Format (1 byte)	Signature Type (1 byte)	Signature Image Size (4 bytes) (BIG Endian)	
JPEG - 1 BMP - 3 TIFF - 4	1-8	0x00000400	0x00010203....

To enable or disable Signature Capture, scan the appropriate bar code below.



Enable Signature Capture
(1)



*Disable Signature Capture
(0)

Signature Capture File Format Selector

Parameter # 313

Select a signature file format appropriate for the system (BMP, TIFF, or JPEG). The digital scanner stores captured signatures in the selected format.



BMP Signature Format
(3)



***JPEG Signature Format**
(1)



TIFF Signature Format
(4)

Signature Capture Bits Per Pixel

Parameter # 314

Select the number of significant bits per pixel (BPP) to use when capturing a signature. Select **1 BPP** for a black and white image, **4 BPP** to assign 1 of 16 levels of grey to each pixel, or **8 BPP** to assign 1 of 256 levels of grey to each pixel.

✓ **NOTE** The digital scanner ignores these settings for JPEG file formats, which only support **8 BPP**.



1 BPP
(0)



4 BPP
(1)



***8 BPP**
(2)

Signature Capture Width

Parameter # 366

The aspect ratio of the Signature Capture Width and Signature Capture Height parameters must match that of the signature capture area. For example, a 4 x 1 inch signature capture area would require a 4 to 1 aspect ratio of width to height.

To set the width of the signature capture box, scan the **Signature Capture Width** bar code, followed by 3 bar codes from [Appendix D, Numeric Bar Codes](#) corresponding to a value in the range of 001 to 752 decimal.



Signature Capture Width
(Default: 400)
(001 - 752 Decimal)

Signature Capture Height

Parameter # 367

To set the height of the signature capture box, scan the **Signature Capture Height** bar code, followed by 3 bar codes from [Appendix D, Numeric Bar Codes](#) corresponding to a value in the range of 001 to 480 decimal.



Signature Capture Height (Default: 100)
(001 - 480 Decimal)

Signature Capture JPEG Quality

Parameter # 421

Scan the **JPEG Quality Value** bar code followed by 3 bar codes from [Appendix D, Numeric Bar Codes](#) corresponding to a value from 005 to 100, where 100 represents the highest quality image.



JPEG Quality Value (Default: 065)
(5 - 100 Decimal)

CHAPTER 7 USB INTERFACE

Introduction

This chapter provides instructions for programming the cradle to interface with a USB host. The digital scanner cradle connects directly to a USB host, or a powered USB hub. The USB host can power the cradle and recharge the digital scanner battery, but this charging method has limitations. See [Using the USB Interface to Supply Power on page 1-9](#).

Throughout the programming bar code menus, default values are indicated with asterisks (*).

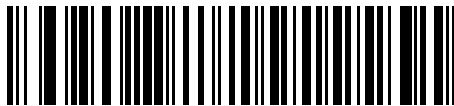

* Indicates Default — *North American Standard USB Keyboard — Feature/Option

✓ **NOTE** The CR0078-S cradle has the ability to be powered by the USB port instead of an external power supply. The CR0078-P can only receive power via an external power supply.

Connecting a USB Interface

- ✓ **NOTE** See [Chapter 4, Radio Communications](#) for information about digital scanner/cradle pairing and wireless communication

The digital scanner must be connected to the cradle for the host parameter setting to take effect. When the digital scanner is not connected to a cradle, and a host parameter bar code is scanned, a long low/long high beep sequence sounds.

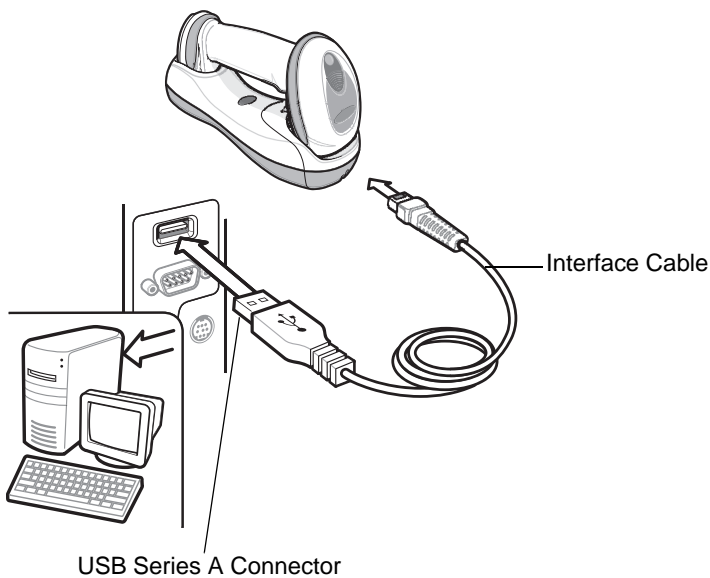

Figure 7-1 USB Connection

The digital scanner cradle connects with USB capable hosts including:

- Desktop PCs and Notebooks
- Apple™ iMac, G4, iBooks (North America only)
- IBM SurePOS terminals
- Sun, IBM, and other network computers that support more than one keyboard.

The following operating systems support the digital scanner cradle through USB:

- Windows 98, 2000, ME, XP
- MacOS 8.5 and above
- IBM 4690 OS.

The digital scanner cradle also interfaces with other USB hosts which support USB Human Interface Devices (HID).

To connect the USB interface:

1. Attach the modular connector of the USB interface cable to the host port on the bottom of the digital scanner cradle (see [Connecting the CR0078-S/CR0008-S Series Cradle on page 1-8](#) or [Connecting the CR0078-P Series Cradle on page 1-9](#)).
2. Plug the series A connector in the USB host or hub, or plug the Plus Power connector in an available port of the IBM SurePOS terminal.
3. Select the USB device type by scanning the appropriate bar code from [USB Device Type on page 7-5](#).
4. On first installation when using Windows, the software prompts to select or install the Human Interface Device driver. To install this driver, provided by Windows, click *Next* through all the choices and click *Finished* on the last choice. The cradle powers up during this installation.
5. To modify any other parameter options, scan the appropriate bar codes in this chapter.

✓ **NOTE** Interface cables vary depending on configuration. The connectors illustrated in [Figure 7-1](#) are examples only. The connectors may be different than those illustrated, but the steps to connect the digital scanner cradle remain the same.

If problems occur with the system, see [Troubleshooting on page 3-4](#).

USB Parameter Defaults

Table 7-1 lists the defaults for USB host parameters. If any option needs to be changed, scan the appropriate bar code(s) provided in the Parameter Descriptions section beginning on [page 7-5](#).

✓ **NOTE** See [Appendix A, Standard Default Parameters](#) for all user preferences, hosts, symbologies, and miscellaneous default parameters.

Table 7-1 *USB Host Default Parameters*

Parameter	Default	Page Number
USB Host Parameters		
USB Device Type	USB Keyboard (HID)	7-5
Symbol Native API (SNAPI) Status Handshaking	Enable	7-7
USB Country Keyboard Types (Country Codes)	North American	7-8
USB Keystroke Delay	No Delay	7-10
USB CAPS Lock Override	Disable	7-10
USB Ignore Unknown Characters	Send	7-11
USB Convert Unknown to Code 39	Disable	7-11
Emulate Keypad	Disable	7-12
Emulate Keypad with Leading Zero	Disable	7-12
Quick Keypad Emulation	Disable	7-13
USB FN1 Substitution	Disable	7-13
USB Static CDC	Enable	7-14
Function Key Mapping	Disable	7-14
Simulated Caps Lock	Disable	7-15
Convert Case	No Case Conversion	7-15
Ignore Beep	Disable	7-16
Ignore Bar Code Configuration	Disable	7-16
USB Polling Interval	8 msec	7-17

USB Host Parameters

USB Device Type

Select the desired USB device type.

- ✓ **NOTE** When changing USB Device Types, the cradle automatically restarts. The digital scanner issues a disconnect-reconnect beep sequence.
- ✓ **NOTE** Select **IBM hand-held USB** to disable data transmission when an IBM register issues a Scan Disable command. Aim, illumination, and decoding is still permitted. Select **IBM OPOS (IBM Hand-held USB with Full Scan Disable)** to completely shut off the scanner when an IBM register issues a Scan Disable command, including aim, illumination, decoding and data transmission.
- ✓ **NOTE** The **SSI over USB CDC** option enables a subset of the SSI protocol over the USB CDC interface which omits all hardware handshaking functionality. For more information refer to the *SSI Programmer's Guide*.
- ✓ **NOTE** SSI over USB CDC, SNAPi with Imaging, and SNAPi without Imaging are only supported for the CR0078-P cradle.
- ✓ **NOTE** For a list of supported scanner functionality by communication protocol, see [Appendix G, Communication Protocol Functionality](#).

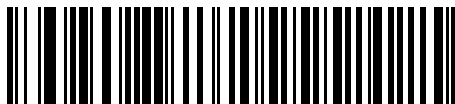

*USB Keyboard (HID)

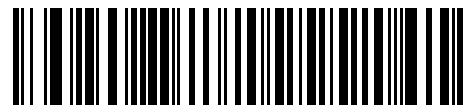

IBM Table-Top USB

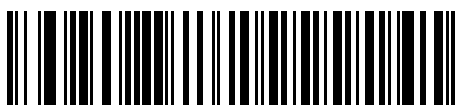

IBM Hand-held USB



IBM OPOS
(IBM Hand-held USB with Full Scan Disable)

USB Device Type (continued)



Simple COM Port Emulation



USB CDC Host

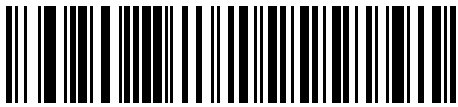

SSI over USB CDC



Symbol Native API (SNAPI) with Imaging Interface



Symbol Native API (SNAPI) without Imaging Interface

Symbol Native API (SNAPI) Status Handshaking

After selecting a SNAPI interface as the USB device type, select whether to enable or disable status handshaking.

✓ **NOTE** The CR0078-P cradle is required for SNAPI.



*Enable SNAPI Status Handshaking



Disable SNAPI Status Handshaking

USB Country Keyboard Types - Country Codes

Scan the bar code corresponding to the keyboard type. This setting applies only to the USB Keyboard (HID) on device.

✓ **NOTE** When changing USB country keyboard types the digital scanner automatically resets. The digital scanner issues the standard startup beep sequences.



*North American Standard USB Keyboard



German Windows

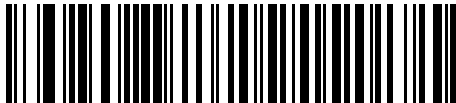

French Windows



French Canadian Windows 95/98



French Canadian Windows 2000/XP



French International

USB Country Keyboard Types - Country Codes (continued)

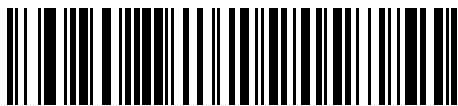

Spanish Windows



Italian Windows

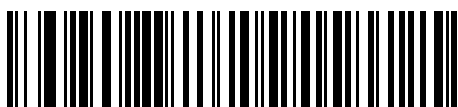

Swedish Windows



UK English Windows

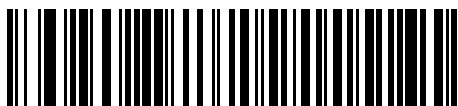

Japanese Windows (ASCII)



Portuguese-Brazilian Windows

USB Keystroke Delay

This parameter sets the delay, in milliseconds, between emulated keystrokes. Scan a bar code below to increase the delay when hosts require a slower transmission of data.



***No Delay**

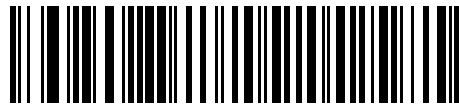

Medium Delay (20 msec)



Long Delay (40 msec)

USB CAPS Lock Override

This option applies only to the USB Keyboard (HID) device. When enabled, the case of the data is preserved regardless of the state of the caps lock key. This setting is always enabled for the “Japanese, Windows (ASCII)” keyboard type and can not be disabled.

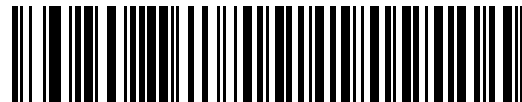

**Override Caps Lock Key
(Enable)**

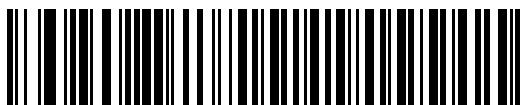

***Do Not Override Caps Lock Key
(Disable)**

USB Ignore Unknown Characters

This option applies only to the USB Keyboard (HID) device and IBM device. Unknown characters are characters the host does not recognize. When **Send Bar Codes With Unknown Characters** is selected, all bar code data is sent except for unknown characters, and no error beeps sound. When **Do Not Send Bar Codes With Unknown Characters** is selected, bar code data is sent up to the first unknown character, then the digital scanner issues an error beep.

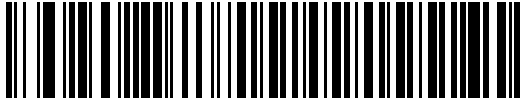

***Send Bar Codes with Unknown Characters**

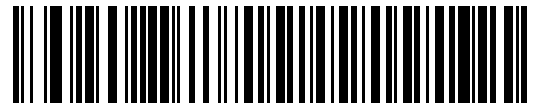

Do Not Send Bar Codes with Unknown Characters

USB Convert Unknown to Code 39

This option applies only to the IBM hand-held, IBM table-top, and OPOS devices. Scan a bar code below to enable or disable converting unknown bar code type data to Code 39.



***Disable Convert Unknown to Code 39**



Enable Convert Unknown to Code 39

Emulate Keypad

When enabled, all characters are sent as ASCII sequences over the numeric keypad. For example ASCII A would be sent as “ALT make” 0 6 5 “ALT Break.”



***Disable Keypad Emulation**

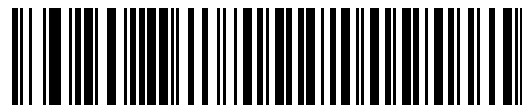

Enable Keypad Emulation

Emulate Keypad with Leading Zero

Enable this to send character sequences sent over the numeric keypad as ISO characters which have a leading zero. For example ASCII A transmits as “ALT MAKE” 0 0 6 5 “ALT BREAK”.



***Disable Keypad Emulation with Leading Zero**



Enable Keypad Emulation with Leading Zero

Quick Keypad Emulation

This option applies only to the USB Keyboard (HID) device and if Emulate Keypad is enabled. This parameter enables a quicker method of keypad emulation where ASCII sequences are only sent for ASCII characters not found on the keyboard. The default value is **Disable**.

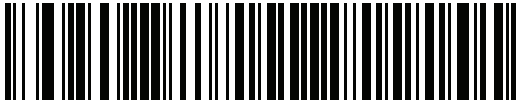

Enable

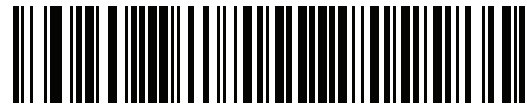

***Disable**

USB Keyboard FN 1 Substitution

This option applies only to the USB Keyboard (HID) device. When enabled, this allows replacement of any FN 1 characters in an EAN 128 bar code with a Key Category and value chosen by the user (see [FN1 Substitution Values on page 5-50](#) to set the Key Category and Key Value).



Enable FN1 Substitution

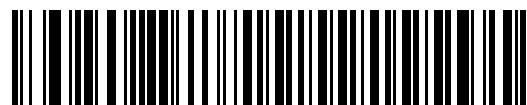

***Disable FN1 Substitution**

USB Static CDC

When disabled, each device connected consumes another COM port (first device = COM1, second device = COM2, third device = COM3, etc.)

When enabled, each device connects to the same COM port.



***Enable USB Static CDC**



Disable USB Static CDC

Function Key Mapping

ASCII values under 32 are normally sent as a control-key sequences (see [Table 7-2 on page 7-19](#)). When this parameter is enabled, the keys in bold are sent in place of the standard key mapping. Table entries that do not have a bold entry remain the same whether or not this parameter is enabled.



***Disable Function Key Mapping**

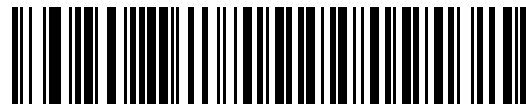

Enable Function Key Mapping

Simulated Caps Lock

When enabled, the digital scanner inverts upper and lower case characters on the digital scanner bar code as if the Caps Lock state is enabled on the keyboard. This inversion is done regardless of the current state of the keyboard's Caps Lock state.

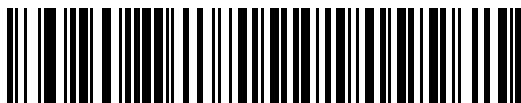

***Disable Simulated Caps Lock**



Enable Simulated Caps Lock

Convert Case

When enabled, the digital scanner converts all bar code data to the selected case.



***No Case Conversion**



Convert All to Upper Case



Convert All to Lower Case

Optional USB Parameters

If you configure the digital scanner and find the settings were not saved, or changed, when the system is restarted scan the bar codes that follow to override USB interface defaults.

Scan a bar code below after setting defaults and before configuring the digital scanner.

Ignore Beep

The host can send a beep request to the digital scanner. When this parameter is enabled, the request is not sent to the attached digital scanner. All directives are still acknowledged to the USB host as if it were processed.



***Disable**



Enable

Ignore Bar Code Configuration

The host has the ability to enable/disable code types. When this parameter is enabled, the request is not sent to the attached digital scanner. All directives are still acknowledged to the USB host as if it were processed.



***Disable**



Enable

USB Polling Interval

Scan a bar code below to set the polling interval. The polling interval determines the rate at which data can be sent between the scanner and host computer. A lower number indicates a faster data rate.



NOTE When changing USB Device Types, the cradle automatically restarts. The digital scanner issues a disconnect-reconnect beep sequence.



IMPORTANT Ensure your host machine can handle the selected data rate.



1 msec

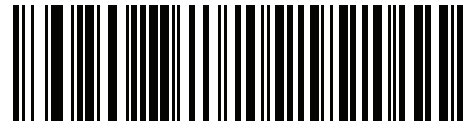

2 msec



3msec



4 msec

USB Polling Interval (continued)



5 msec



6 msec



7 msec



* 8 msec

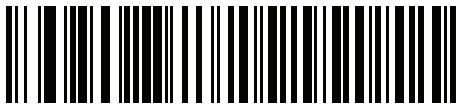

9 msec

ASCII Character Set for USB

Table 7-2 ASCII Character Set for USB

ASCII Value	Full ASCII Code 39 Encode Character	Keystroke
1000	%U	CTRL 2
1001	\$A	CTRL A
1002	\$B	CTRL B
1003	\$C	CTRL C
1004	\$D	CTRL D
1005	\$E	CTRL E
1006	\$F	CTRL F
1007	\$G	CTRL G
1008	\$H	CTRL H/ BACKSPACE ¹
1009	\$I	CTRL I/ HORIZONTAL TAB ¹
1010	\$J	CTRL J
1011	\$K	CTRL K
1012	\$L	CTRL L
1013	\$M	CTRL M/ ENTER ¹
1014	\$N	CTRL N
1015	\$O	CTRL O
1016	\$P	CTRL P
1017	\$Q	CTRL Q
1018	\$R	CTRL R
1019	\$S	CTRL S
1020	\$T	CTRL T
1021	\$U	CTRL U
1022	\$V	CTRL V
1023	\$W	CTRL W
1024	\$X	CTRL X

¹The keystroke in bold is sent only if the "Function Key Mapping" is enabled. Otherwise, the unbolded keystroke is sent.

Table 7-2 ASCII Character Set for USB (Continued)

ASCII Value	Full ASCII Code 39 Encode Character	Keystroke
1025	\$Y	CTRL Y
1026	\$Z	CTRL Z
1027	%A	CTRL [/ESC ¹
1028	%B	CTRL \
1029	%C	CTRL]
1030	%D	CTRL 6
1031	%E	CTRL -
1032	Space	Space
1033	/A	!
1034	/B	“
1035	/C	#
1036	/D	\$
1037	/E	%
1038	/F	&
1039	/G	‘
1040	/H	(
1041	/I)
1042	/J	*
1043	/K	+
1044	/L	,
1045	-	-
1046	.	.
1047	/O	/
1048	0	0
1049	1	1
1050	2	2
1051	3	3
1052	4	4

¹The keystroke in bold is sent only if the “Function Key Mapping” is enabled. Otherwise, the unbolded keystroke is sent.

Table 7-2 ASCII Character Set for USB (Continued)

ASCII Value	Full ASCII Code 39 Encode Character	Keystroke
1053	5	5
1054	6	6
1055	7	7
1056	8	8
1057	9	9
1058	/Z	:
1059	%F	;
1060	%G	<
1061	%H	=
1062	%I	>
1063	%J	?
1064	%V	@
1065	A	A
1066	B	B
1067	C	C
1068	D	D
1069	E	E
1070	F	F
1071	G	G
1072	H	H
1073	I	I
1074	J	J
1075	K	K
1076	L	L
1077	M	M
1078	N	N
1079	O	O
1080	P	P
1081	Q	Q

¹The keystroke in bold is sent only if the "Function Key Mapping" is enabled. Otherwise, the unbolded keystroke is sent.

Table 7-2 ASCII Character Set for USB (Continued)

ASCII Value	Full ASCII Code 39 Encode Character	Keystroke
1082	R	R
1083	S	S
1084	T	T
1085	U	U
1086	V	V
1087	W	W
1088	X	X
1089	Y	Y
1090	Z	Z
1091	%K	[
1092	%L	\
1093	%M]
1094	%N	^
1095	%O	_
1096	%W	`
1097	+A	a
1098	+B	b
1099	+C	c
1100	+D	d
1101	+E	e
1102	+F	f
1103	+G	g
1104	+H	h
1105	+I	i
1106	+J	j
1107	+K	k
1108	+L	l
1109	+M	m
1110	+N	n

¹The keystroke in bold is sent only if the "Function Key Mapping" is enabled. Otherwise, the unbolded keystroke is sent.

Table 7-2 ASCII Character Set for USB (Continued)

ASCII Value	Full ASCII Code 39 Encode Character	Keystroke
1111	+O	o
1112	+P	p
1113	+Q	q
1114	+R	r
1115	+S	s
1116	+T	t
1117	+U	u
1118	+V	v
1119	+W	w
1120	+X	x
1121	+Y	y
1122	+Z	z
1123	%P	{
1124	%Q	
1125	%R	}
1126	%S	~

¹The keystroke in bold is sent only if the "Function Key Mapping" is enabled. Otherwise, the unbolded keystroke is sent.

Table 7-3 USB ALT Key Character Set

ALT Keys	Keystroke
2064	ALT 2
2065	ALT A
2066	ALT B
2067	ALT C
2068	ALT D
2069	ALT E
2070	ALT F
2071	ALT G
2072	ALT H
2073	ALT I
2074	ALT J
2075	ALT K
2076	ALT L
2077	ALT M
2078	ALT N
2079	ALT O
2080	ALT P
2081	ALT Q
2082	ALT R
2083	ALT S
2084	ALT T
2085	ALT U
2086	ALT V
2087	ALT W
2088	ALT X
2089	ALT Y
2090	ALT Z

Table 7-4 USB GUI Key Character Set

GUI Key	Keystroke
3000	Right Control Key
3048	GUI 0
3049	GUI 1
3050	GUI 2
3051	GUI 3
3052	GUI 4
3053	GUI 5
3054	GUI 6
3055	GUI 7
3056	GUI 8
3057	GUI 9
3065	GUI A
3066	GUI B
3067	GUI C
3068	GUI D
3069	GUI E
3070	GUI F
3071	GUI G
3072	GUI H
3073	GUI I
3074	GUI J
3075	GUI K
3076	GUI L
3077	GUI M
3078	GUI N
3079	GUI O
3080	GUI P
3081	GUI Q

Note: GUI Shift Keys - The Apple™ iMac keyboard has an apple key on either side of the space bar. Windows-based systems have a GUI key to the left of the left ALT key, and to the right of the right ALT key.

Table 7-4 *USB GUI Key Character Set (Continued)*

GUI Key	Keystroke
3082	GUI R
3083	GUI S
3084	GUI T
3085	GUI U
3086	GUI V
3087	GUI W
3088	GUI X
3089	GUI Y
3090	GUI Z

Note: GUI Shift Keys - The Apple™ iMac keyboard has an apple key on either side of the space bar. Windows-based systems have a GUI key to the left of the left ALT key, and to the right of the right ALT key.

Table 7-5 *USB F Key Character Set*

F Keys	Keystroke
5001	F1
5002	F2
5003	F3
5004	F4
5005	F5
5006	F6
5007	F7
5008	F8
5009	F9
5010	F10
5011	F11
5012	F12
5013	F13
5014	F14
5015	F15
5016	F16
5017	F17

Table 7-5 *USB F Key Character Set (Continued)*

F Keys	Keystroke
5018	F18
5019	F19
5020	F20
5021	F21
5022	F22
5023	F23
5024	F24

Table 7-6 *USB Numeric Keypad Character Set*

Numeric Keypad	Keystroke
6042	*
6043	+
6044	undefined
6045	-
6046	.
6047	/
6048	0
6049	1
6050	2
6051	3
6052	4
6053	5
6054	6
6055	7
6056	8
6057	9
6058	Enter
6059	Num Lock

Table 7-7 *USB Extended Keypad Character Set*

Extended Keypad	Keystroke
7001	Break
7002	Delete
7003	PgUp
7004	End
7005	Pg Dn
7006	Pause
7007	Scroll Lock
7008	Backspace
7009	Tab
7010	Print Screen
7011	Insert
7012	Home
7013	Enter
7014	Escape
7015	Up Arrow
7016	Down Arrow
7017	Left Arrow
7018	Right Arrow

CHAPTER 8 RS-232 INTERFACE

Introduction

This chapter provides instructions for programming the cradle to interface with an RS-232 host interface. The RS-232 interface is used to attach the scanner cradle to point-of-sale devices, host computers, or other devices with an available RS-232 port (i.e., COM port).

If the particular host is not listed in [Table 8-2](#), set the communication parameters to match the host device. Refer to the documentation for the host device.

- ✓ **NOTE** This digital scanner uses TTL RS-232 signal levels, which interface with most system architectures. For system architectures requiring RS-232C signal levels, Zebra offers different cables providing the TTL to RS-232C conversion. Contact Support for more information.

Throughout the programming bar code menus, default values are indicated with asterisks (*).

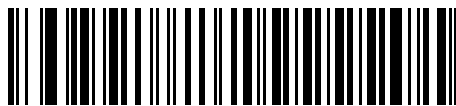

* Indicates Default *Baud Rate 9,600 Feature/Option

Connecting an RS-232 Interface

- ✓ See [Chapter 4, Radio Communications](#) for information about digital scanner/cradle pairing and wireless communication.

The digital scanner must be connected to the cradle for the host parameter setting to take effect. When the digital scanner is not connected to a cradle, and a host parameter bar code is scanned, a long low/long high beep sequence sounds.

This connection is made directly from the cradle to the host computer.

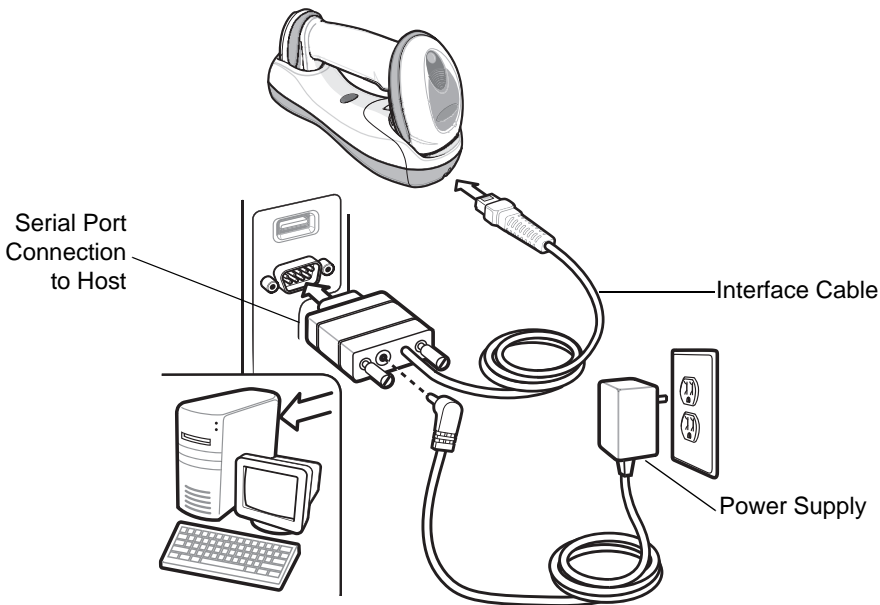

Figure 8-1 RS-232 Direct Connection

To connect the RS-232 interface:

1. Attach the modular connector of the RS-232 interface cable to the host port on the bottom of the scanner cradle (see [Connecting the CR0078-S/CR0008-S Series Cradle on page 1-8](#) or [Connecting the CR0078-P Series Cradle on page 1-9](#)).
2. Connect the other end of the RS-232 interface cable to the serial port on the host.
3. Connect the power supply to the serial connector end of the RS-232 interface cable. Plug the power supply into an appropriate outlet.
4. Select the RS-232 host type by scanning the appropriate bar code from [RS-232 Host Types on page 8-6](#).
5. To modify any other parameter options, scan the appropriate bar codes in this chapter.

- ✓ **NOTE** Interface cables vary depending on configuration. The connectors illustrated in [Figure 8-1](#) are examples only. The connectors may be different than those illustrated, but the steps to connect the cradle remain the same.

If a power supply is used, disconnect the power supply before changing host cables or the cradle may not recognize the new host.

RS-232 Parameter Defaults

Table 8-1 lists the defaults for RS-232 host parameters. If any option needs to be changed, scan the appropriate bar code(s) provided in the Parameter Descriptions section beginning on [page 8-4](#).

✓ **NOTE** See [Appendix A, Standard Default Parameters](#) for all user preferences, hosts, symbologies, and miscellaneous default parameters.

Table 8-1 *RS-232 Host Default Parameters*

Parameter	Default	Page Number
RS-232 Host Parameters		
RS-232 Host Types	Standard	8-6
Baud Rate	9600	8-8
CR0078-P Baud Rate	None	8-8
Parity Type	None	8-9
Data Bits (ASCII Format)	8-Bit	8-9
Check Receive Errors	Enable	8-10
Hardware Handshaking	None	8-10
Software Handshaking	None	8-12
Host Serial Response Time-out	2 sec	8-14
RTS Line State	Low RTS	8-15
Beep on <BEL>	Disable	8-15
Intercharacter Delay	0 msec	8-16
Nixdorf Beep/LED Options	Normal Operation	8-17
Ignore Unknown Characters	Send Bar Code	8-17

RS-232 Host Parameters

Various RS-232 hosts are set up with their own parameter default settings (*Table 8-2*). Selecting the ICL, Fujitsu, Wincor-Nixdorf Mode A, Wincor-Nixdorf Mode B, Olivetti, Omron, or terminal sets the defaults listed below.

Table 8-2 Terminal Specific RS-232

Parameter	ICL	Fujitsu	Wincor-Nixdorf Mode A	Wincor-Nixdorf Mode B/ OPOS/JPOS	Olivetti	Omron	CUTE
Transmit Code ID	Yes	Yes	Yes	Yes	Yes	Yes	Yes
Data Transmission Format	Data/Suffix	Data/Suffix	Data/Suffix	Data/Suffix	Prefix/Data/Suffix	Data/Suffix	Prefix/Data/Suffix
Suffix	CR (1013)	CR (1013)	CR (1013)	CR (1013)	ETX (1002)	CR (1013)	CR (1013) ETX (1003)
Baud Rate	9600	9600	9600	9600	9600	9600	9600
Parity	Even	None	Odd	Odd	Even	None	Even
Hardware Handshaking	RTS/CTS Option 3	None	RTS/CTS Option 3	RTS/CTS Option 3	None	None	None
Software Handshaking	None	None	None	None	ACK/NAK	None	None
Serial Response Time-out	9.9 Sec.	2 Sec.	9.9 Sec.	9.9 Sec.	9.9 Sec.	9.9 Sec.	9.9 Sec.
Stop Bit Select	One	One	One	One	One	One	One
ASCII Format	8-Bit	8-Bit	8-Bit	8-Bit	7-Bit	8-Bit	7-Bit
Beep On <BEL>	Disable	Disable	Disable	Disable	Disable	Disable	Disable
RTS Line State	High	Low	Low	Low = No data to send	Low	High	High
Prefix	None	None	None	None	STX (1003)	None	STX (1002)

In the Nixdorf Mode B, if CTS is low, scanning is disabled. When CTS is high, scanning is enabled. If you scan Nixdorf Mode B without connecting the digital scanner to the proper host, it may appear unable to scan. If this happens, scan a different RS-232 host type within 5 seconds of cycling power to the digital scanner.

The CUTE host disables all parameter scanning, including Set Defaults. If you inadvertently select CUTE, scan **Enable Parameter Bar Code Scanning (1)* on page 5-6, then change the host selection.

RS-232 Host Parameters (continued)

Selecting the ICL, Fujitsu, Wincor-Nixdorf Mode A, Wincor-Nixdorf Mode B, OPOS terminal enables the transmission of code ID characters listed in [Table 8-3](#) below. These code ID characters are not programmable and are separate from the Transmit Code ID feature. The Transmit Code ID feature should not be enabled for these terminals.

Table 8-3 Terminal Specific Code ID Characters

Code Type	ICL	Fujitsu	Wincor-Nixdorf Mode A	Wincor-Nixdorf Mode B/ OPOS/JPOS	Olivetti	Omron	CUTE
UPC-A	A	A	A	A	A	A	A
UPC-E	E	E	C	C	C	E	None
EAN-8/JAN-8	FF	FF	B	B	B	FF	None
EAN-13/JAN-13	F	F	A	A	A	F	A
Code 39	C <len>	None	M	M	M <len>	C <len>	3
Code 39 Full ASCII	None	None	M	M	None	None	3
Codabar	N <len>	None	N	N	N <len>	N <len>	None
Code 128	L <len>	None	K	K	K <len>	L <len>	5
I 2 of 5	I <len>	None	I	I	I <len>	I <len>	1
Code 93	None	None	L	L	L <len>	None	None
D 2 of 5	H <len>	None	H	H	H <len>	H <len>	2
GS1-128	L <len>	None	P	P	P <len>	L <len>	5
MSI	None	None	O	O	O <len>	None	None
Bookland EAN	F	F	A	A	A	F	None
Trioptic	None	None	None	None	None	None	None
Code 11	None	None	None	None	None	None	None
IATA	H<len>	None	H	H	H <len>	H <len>	2
Code 32	None	None	None	None	None	None	None
GS1 Databar Variants	None	None	E	E	None	None	None
PDF417	None	None	Q	Q	None	None	6
Datamatrix	None	None	R	R	None	None	4
QR Codes	None	None	U	U	None	None	7
Aztec/Aztec Rune	None	None	V	V	None	None	8
Micro PDF	None	None	S	S	None	None	6
Maxicode	None	None	T	T	None	None	None

RS-232 Host Types

To select an RS-232 host interface, scan one of the following bar codes.



NOTE For a list of supported scanner functionality by communication protocol, see [Appendix G, Communication Protocol Functionality](#).

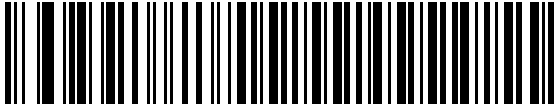

***Standard RS-232**

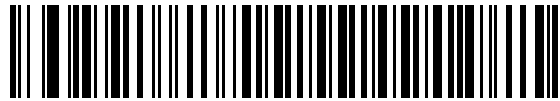

ICL RS-232

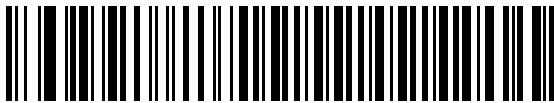

Wincor-Nixdorf RS-232 Mode A

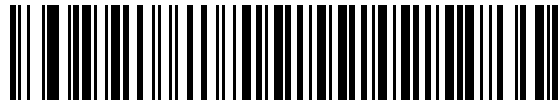

Wincor-Nixdorf RS-232 Mode B

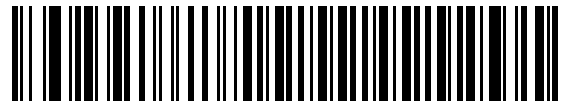
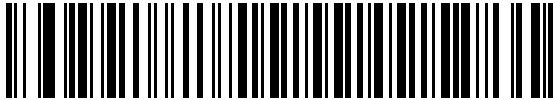
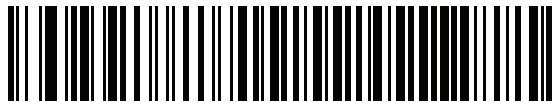

Olivetti ORS4500

RS-232 Host Types (continued)**Omron****OPOS/JPOS****Fujitsu RS-232****SITA/CUTE**

NOTE The SITA/CUTE host disables all parameter scanning, including set defaults. If the SITA/CUTE parameter is inadvertently selected, scan *[*Enable Parameter Bar Code Scanning \(1\) on page 5-6](#)*, then change the host selection.

Baud Rate

Baud rate is the number of bits of data transmitted per second. Set the digital scanner's baud rate to match the baud rate setting of the host device. Otherwise, data may not reach the host device or may reach it in distorted form.



***Baud Rate 9600**



Baud Rate 19,200

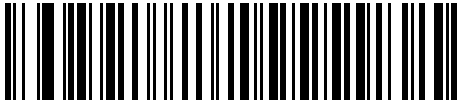

Baud Rate 38,400

The following baud rate parameters (**Baud Rate 57,600** and **Baud Rate 115,200**) apply to the CR0078-P cradle only.



Baud Rate 57,600



Baud Rate 115,200

Parity

A parity check bit is the most significant bit of each ASCII coded character. Select the parity type according to host device requirements.

- Select **Odd** parity and the parity bit value is set to 0 or 1, based on data, to ensure that an odd number of 1 bits are contained in the coded character.
- Select **Even** parity and the parity bit value is set to 0 or 1, based on data, to ensure that an even number of 1 bits are contained in the coded character.
- Select **None** when no parity bit is required.

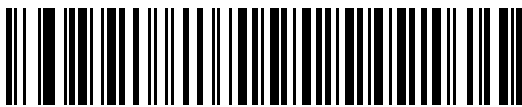

Odd

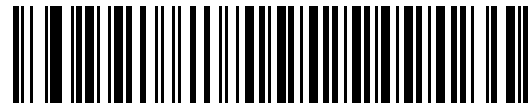

Even

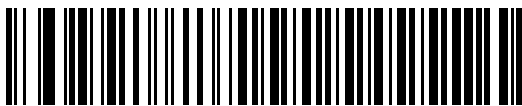

*None

Data Bits (ASCII Format)

This parameter allows the digital scanner to interface with devices requiring a 7-bit or 8-bit ASCII protocol.

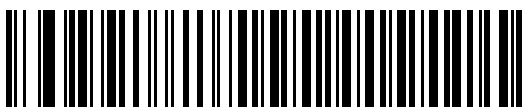

7-Bit

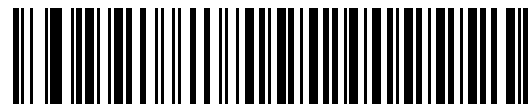

*8-Bit

Check Receive Errors

Select whether or not the parity, framing, and overrun of received characters are checked. The parity value of received characters is verified against the parity parameter selected above.



***Check For Received Errors
(Enable)**

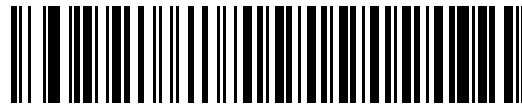

**Do Not Check For Received Errors
(Disable)**

Hardware Handshaking

The data interface consists of an RS-232 port designed to operate either with or without the hardware handshaking lines, *Request to Send* (RTS), and *Clear to Send* (CTS).

If Standard RTS/CTS handshaking is not selected, scan data is transmitted as it becomes available. If Standard RTS/CTS handshaking is selected, scan data is transmitted according to the following sequence:

- The digital scanner reads the CTS line for activity. If CTS is asserted, the digital scanner waits up to Host Serial Response Time-out for the host to de-assert the CTS line. If, after Host Serial Response Time-out, the CTS line is still asserted, the digital scanner sounds a transmit error, and any scanned data is lost.
- When the CTS line is de-asserted, the digital scanner asserts the RTS line and waits up to Host Serial Response Time-out for the host to assert CTS. When the host asserts CTS, data is transmitted. If, after Host Serial Response Time-out, the CTS line is not asserted, the digital scanner sounds a transmit error, and discards the data.
- When data transmission is complete, the digital scanner de-asserts RTS 10 msec after sending the last character.
- The host should respond by negating CTS. The digital scanner checks for a de-asserted CTS upon the next transmission of data.

During the transmission of data, the CTS line should be asserted. If CTS is de-asserted for more than 50 ms between characters, the transmission is aborted, the digital scanner sounds a transmission error, and the data is discarded.

If the above communication sequence fails, the digital scanner issues an error indication. In this case, the data is lost and must be rescanned.

If Hardware Handshaking and Software Handshaking are both enabled, Hardware Handshaking takes precedence.



NOTE The DTR signal is jumpered to the active state.

Hardware Handshaking (continued)

- **None:** Scan the bar code below if no Hardware Handshaking is desired.
- **Standard RTS/CTS:** Scan the bar code below to select Standard RTS/CTS Hardware Handshaking.
- **RTS/CTS Option 1:** When RTS/CTS Option 1 is selected, the digital scanner asserts RTS before transmitting and ignores the state of CTS. The digital scanner de-asserts RTS when the transmission is complete.
- **RTS/CTS Option 2:** When Option 2 is selected, RTS is always high or low (user-programmed logic level). However, the digital scanner waits for CTS to be asserted before transmitting data. If CTS is not asserted within Host Serial Response Time-out, the digital scanner issues an error indication and discards the data.
- **RTS/CTS Option 3:** When Option 3 is selected, the digital scanner asserts RTS prior to any data transmission, regardless of the state of CTS. The digital scanner waits up to Host Serial Response Time-out for CTS to be asserted. If CTS is not asserted during this time, the digital scanner issues an error indication and discards the data. The digital scanner de-asserts RTS when transmission is complete.

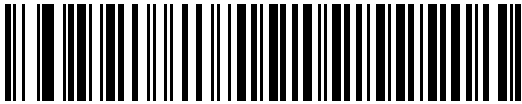

***None**



Standard RTS/CTS

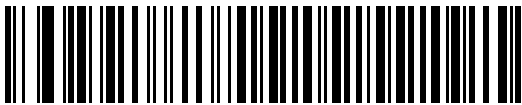

RTS/CTS Option 1



RTS/CTS Option 2



RTS/CTS Option 3

Software Handshaking

This parameter offers control of the data transmission process in addition to, or instead of, that offered by hardware handshaking. There are five options.

If Software Handshaking and Hardware Handshaking are both enabled, Hardware Handshaking takes precedence.

- **None:** Data is transmitted immediately. No response is expected from host.
- **ACK/NAK:** After transmitting data, the digital scanner expects either an ACK or NAK response from the host. When the digital scanner receives a NAK, it re-transmits the data and waits for either an ACK or NAK. After three unsuccessful attempts to send data after receiving NAKs, the digital scanner issues an error indication and discards the data.

The digital scanner waits up to the programmable Host Serial Response Time-out to receive an ACK or NAK. If the digital scanner does not get a response in this time, it issues an error indication and discards the data. There are no retries when a time-out occurs.

- **ENQ:** The digital scanner waits for an ENQ character from the host before transmitting data. If an ENQ is not received within the Host Serial Response Time-out, the digital scanner issues an error indication and discards the data. The host must transmit an ENQ character at least every Host Serial Response Time-out to prevent transmission errors.
- **ACK/NAK with ENQ:** This combines the two previous options. For re-transmissions of data, due to a NAK from the host, an additional ENQ is not required.
- **XON/XOFF:** An XOFF character turns the digital scanner transmission off until the digital scanner receives an XON character. There are two situations for XON/XOFF:
 - XOFF is received before the digital scanner has data to send. When the digital scanner has data to send, it waits up to Host Serial Response Time-out for an XON character before transmission. If the XON is not received within this time, the digital scanner issues an error indication and discards the data.
 - XOFF is received during a transmission. Data transmission then stops after sending the current byte. When the digital scanner receives an XON character, it sends the rest of the data message. The digital scanner waits up to 30 seconds for the XON.

Software Handshaking (continued)

***None**

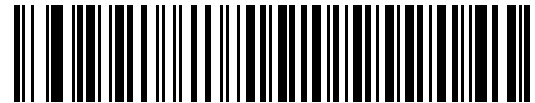

ACK/NAK

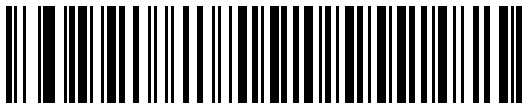

ENQ



ACK/NAK with ENQ



XON/XOFF

Host Serial Response Time-out

This parameter specifies how long the digital scanner waits for an ACK, NAK, ENQ, XON, or CTS before determining that a transmission error occurred.



***Minimum: 2 sec**



Low: 2.5 sec

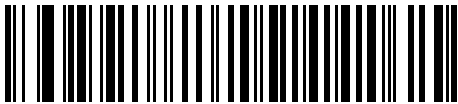

Medium: 5 sec

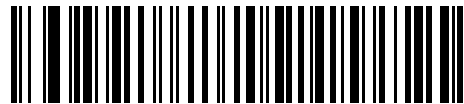

High: 7.5 sec

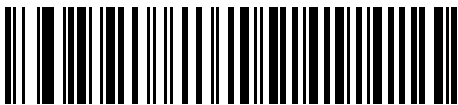

Maximum: 9.9 sec

RTS Line State

This parameter sets the idle state of the Serial Host RTS line. Scan a bar code below to select **Low RTS** or **High RTS** line state.

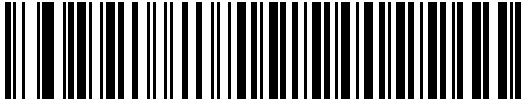

***Host: Low RTS**



Host: High RTS

Beep on <BEL>

Point-to-Point Mode Only

When this parameter is enabled, the digital scanner issues a beep when a <BEL> character is detected on the RS-232 serial line. <BEL> is issued to gain a user's attention to an illegal entry or other important event.



NOTE This parameter is not supported in Multipoint-to-Point mode.



**Beep On <BEL> Character
(Enable)**



***Do Not Beep On <BEL> Character
(Disable)**

Intercharacter Delay

This parameter specifies the intercharacter delay inserted between character transmissions.

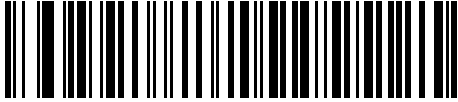

***Minimum: 0 msec**



Low: 25 msec

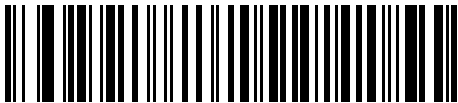

Medium: 50 msec



High: 75 msec

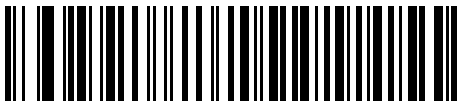

Maximum: 99 msec

Nixdorf Beep/LED Options

When Nixdorf Mode B is selected, this indicates when the digital scanner beeps and turns on its LED after a decode.



***Normal Operation**
(Beep/LED immediately after decode)

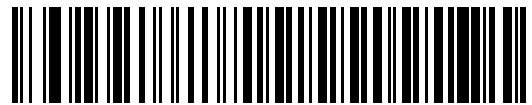

Beep/LED After Transmission

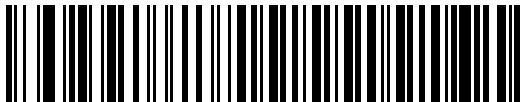

Beep/LED After CTS Pulse

Ignore Unknown Characters

Unknown characters are characters the host does not recognize. When **Send Bar Codes with Unknown Characters** is selected, all bar code data is sent except for unknown characters, and no error beeps sound on the digital scanner. When **Do Not Send Bar Codes With Unknown Characters** is selected, bar code data is sent up to the first unknown character and then an error beep sounds on the digital scanner.

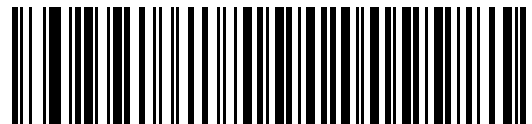

***Send Bar Code with Unknown Characters**



Do Not Send Bar Codes with Unknown Characters

ASCII Character Set for RS-232

The values in [Table 8-4](#) can be assigned as prefixes or suffixes for ASCII character data transmission.

Table 8-4 ASCII Character Set for RS-232

ASCII Value	Full ASCII Code 39 Encode Character	ASCII Character
1000	%U	NUL
1001	\$A	SOH
1002	\$B	STX
1003	\$C	ETX
1004	\$D	EOT
1005	\$E	ENQ
1006	\$F	ACK
1007	\$G	BELL
1008	\$H	BCKSPC
1009	\$I	HORIZ TAB
1010	\$J	LF/NW LN
1011	\$K	VT
1012	\$L	FF
1013	\$M	CR/ENTER
1014	\$N	SO
1015	\$O	SI
1016	\$P	DLE
1017	\$Q	DC1/XON
1018	\$R	DC2
1019	\$S	DC3/XOFF
1020	\$T	DC4
1021	\$U	NAK
1022	\$V	SYN
1023	\$W	ETB
1024	\$X	CAN
1025	\$Y	EM
1026	\$Z	SUB
1027	%A	ESC

Table 8-4 ASCII Character Set for RS-232 (Continued)

ASCII Value	Full ASCII Code 39 Encode Character	ASCII Character
1028	%B	FS
1029	%C	GS
1030	%D	RS
1031	%E	US
1032	Space	Space
1033	/A	!
1034	/B	"
1035	/C	#
1036	/D	\$
1037	/E	%
1038	/F	&
1039	/G	'
1040	/H	(
1041	/I)
1042	/J	*
1043	/K	+
1044	/L	,
1045	-	-
1046	.	.
1047	/O	/
1048	0	0
1049	1	1
1050	2	2
1051	3	3
1052	4	4
1053	5	5
1054	6	6
1057	7	7
1056	8	8
1057	9	9
1058	/Z	:

Table 8-4 ASCII Character Set for RS-232 (Continued)

ASCII Value	Full ASCII Code 39 Encode Character	ASCII Character
1059	%F	;
1060	%G	<
1061	%H	=
1062	%I	>
1063	%J	?
1064	%V	@
1065	A	A
1066	B	B
1067	C	C
1068	D	D
1069	E	E
1070	F	F
1071	G	G
1072	H	H
1073	I	I
1074	J	J
1075	K	K
1076	L	L
1077	M	M
1078	N	N
1079	O	O
1080	P	P
1081	Q	Q
1082	R	R
1083	S	S
1084	T	T
1085	U	U
1086	V	V
1087	W	W
1088	X	X
1089	Y	Y

Table 8-4 ASCII Character Set for RS-232 (Continued)

ASCII Value	Full ASCII Code 39 Encode Character	ASCII Character
1090	Z	Z
1091	%K	[
1092	%L	\
1093	%M]
1094	%N	^
1095	%O	_
1096	%W	`
1097	+A	a
1098	+B	b
1099	+C	c
1100	+D	d
1101	+E	e
1102	+F	f
1103	+G	g
1104	+H	h
1105	+I	i
1106	+J	j
1107	+K	k
1108	+L	l
1109	+M	m
1110	+N	n
1111	+O	o
1112	+P	p
1113	+Q	q
1114	+R	r
1115	+S	s
1116	+T	t
1117	+U	u
1118	+V	v
1119	+W	w
1120	+X	x

Table 8-4 ASCII Character Set for RS-232 (Continued)

ASCII Value	Full ASCII Code 39 Encode Character	ASCII Character
1121	+Y	y
1122	+Z	z
1123	%P	{
1124	%Q	
1125	%R	}
1126	%S	~
1127		Undefined
7013		ENTER

CHAPTER 9 KEYBOARD WEDGE INTERFACE

Introduction

This chapter provides instructions for programming the cradle for keyboard wedge host interface, used to connect the cradle between the keyboard and host computer. The digital scanner translates the bar code data into keystrokes, and transmits the information to the host computer via the cradle interface. The host computer accepts the keystrokes as if they originated from the keyboard.

This interface adds bar code reading functionality to a system designed for manual keyboard input. In this mode the keyboard keystrokes are simply passed through.

Throughout the programming bar code menus, default values are indicated with asterisks (*).



* Indicates Default ***North American** — Feature/Option

Connecting a Keyboard Wedge Interface

✓ **NOTE** See [Chapter 4, Radio Communications](#) for information about digital scanner/cradle pairing and wireless communication.

The digital scanner must be connected to the cradle for the host parameter setting to take effect. When the digital scanner is not connected to a cradle, and a host parameter bar code is scanned, a long low/long high beep sequence sounds.

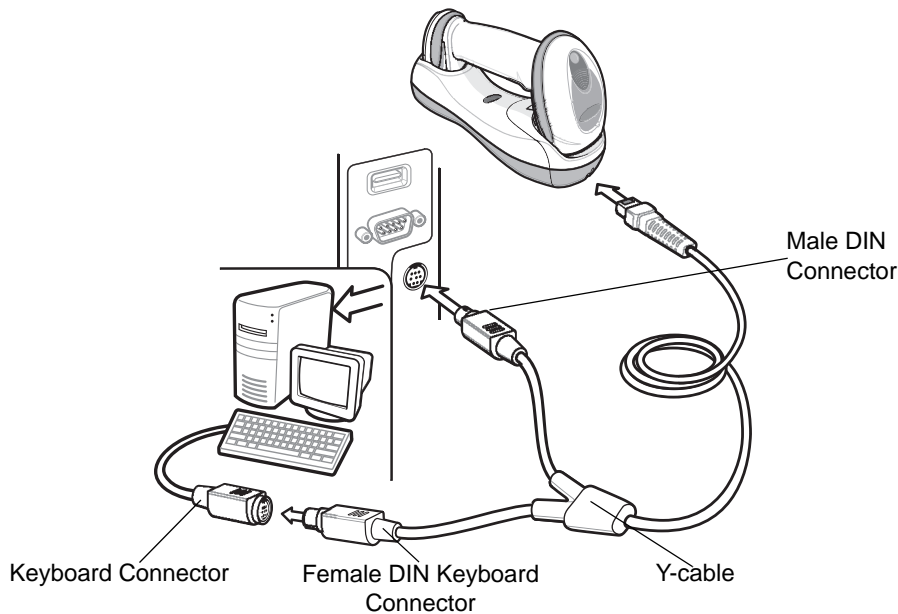

Figure 9-1 Keyboard Wedge Connection with Y-cable

To connect the Keyboard Wedge interface Y-cable:

1. Turn off the host and unplug the keyboard connector.
2. Attach the modular connector of the Y-cable to the host port on the bottom of the digital scanner cradle (see [Connecting the CR0078-S/CR0008-S Series Cradle on page 1-8](#) or [Connecting the CR0078-P Series Cradle on page 1-9](#)).
3. Connect the round male DIN host connector of the Y-cable to the keyboard port on the host device.
4. Connect the round female DIN keyboard connector of the Y-cable to the keyboard connector.
5. If needed, attach the optional power supply to the connector in the middle of the Y-cable.
6. Ensure that all connections are secure.
7. Turn on the host system.
8. Select the Keyboard Wedge host type by scanning the appropriate bar code from [Keyboard Wedge Host Parameters on page 9-4](#).
9. To modify any other parameter options, scan the appropriate bar codes in this chapter.

✓ **NOTE** Interface cables vary depending on configuration. The connectors illustrated in [Figure 9-1](#) are examples only. The connectors may be different than those illustrated, but the steps to connect the cradle remain the same.

If a power supply is used, disconnect the power supply before changing host cables or the cradle may not recognize the new host.

Keyboard Wedge Parameter Defaults

Table 9-1 lists the defaults for Keyboard Wedge host parameters. To change any option, scan the appropriate bar code(s) in the Keyboard Wedge Host Parameters section beginning on [page 9-4](#).

✓ **NOTE** See [Appendix A, Standard Default Parameters](#) for all user preferences, hosts, symbologies, and miscellaneous default parameters.

Table 9-1 *Keyboard Wedge Host Default Parameters*

Parameter	Default	Page Number
Keyboard Wedge Host Parameters		
Keyboard Wedge Host Type	IBM PC/AT& IBM PC Compatibles	9-4
Country Types (Country Codes)	North American	9-5
Ignore Unknown Characters	Send	9-7
Keystroke Delay	No Delay	9-7
Intra-Keystroke Delay	Disable	9-8
Alternate Numeric Keypad Emulation	Disable	9-8
Caps Lock On	Disable	9-9
Caps Lock Override	Disable	9-9
Convert Wedge Data	No Convert	9-10
Function Key Mapping	Disable	9-10
FN1 Substitution	Disable	9-11
Send and Make Break	Send	9-11

Keyboard Wedge Host Parameters

Keyboard Wedge Host Types

Select the Keyboard Wedge host by scanning one of the bar codes below.

✓ **NOTE** For a list of supported scanner functionality by communication protocol, see [Appendix G, Communication Protocol Functionality](#).

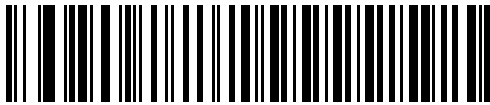

***IBM PC/AT & IBM PC Compatibles**

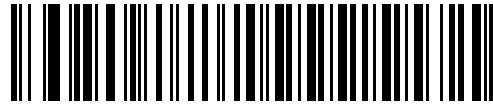

IBM AT Notebook

Keyboard Wedge Country Types (Country Codes)

Scan the bar code corresponding to the keyboard type. If the keyboard type is not listed, see [Alternate Numeric Keypad Emulation on page 9-8](#).



***North American**

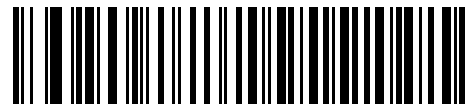

German Windows

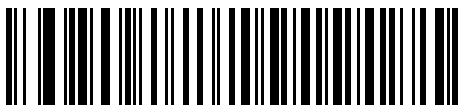

French Windows

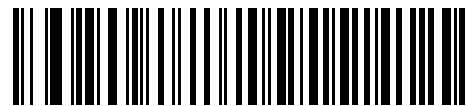

French Canadian Windows 95/98

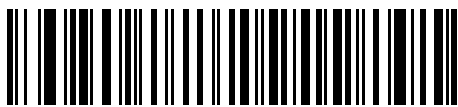

French Canadian Windows XP/2000



Spanish Windows

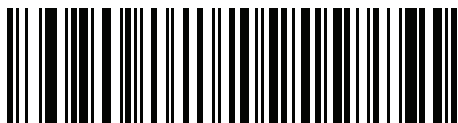

French International

Keyboard Wedge Country Types (Country Codes) (continued)



Italian Windows

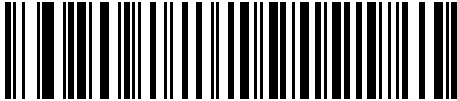

Swedish Windows



UK English Windows

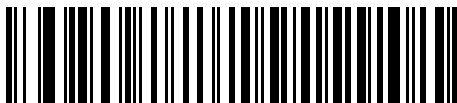

Japanese Windows



Portuguese-Brazilian Windows

Ignore Unknown Characters

Unknown characters are characters the host does not recognize. When **Send Bar Codes With Unknown Characters** is selected, all bar code data is sent except for unknown characters, and no error beeps sound on the digital scanner. When **Do Not Send Bar Codes With Unknown Characters** is selected, bar code data is sent up to the first unknown character, then the digital scanner issues an error beep.

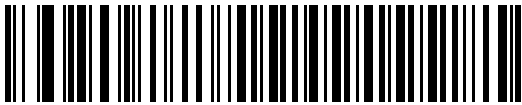

***Send Bar Codes with Unknown Characters**

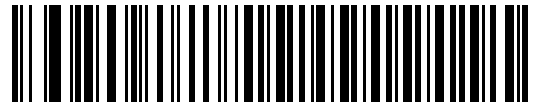

Do Not Send Bar Codes with Unknown Characters

Keystroke Delay

This is the delay in milliseconds between emulated keystrokes. Scan a bar code below to increase the delay when hosts require a slower transmission of data.

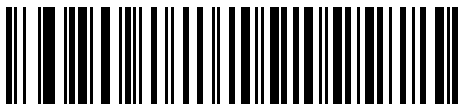

***No Delay**



Medium Delay (20 msec)

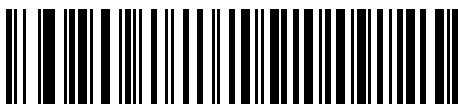

Long Delay (40 msec)

Intra-Keystroke Delay

When enabled, an additional delay is inserted between each emulated key depression and release. This sets the Keystroke Delay parameter to a minimum of 5 msec as well.



Enable Intra-Keystroke Delay

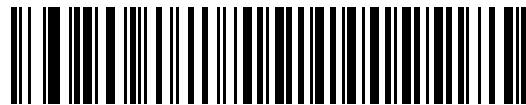

***Disable Intra-Keystroke Delay**

Alternate Numeric Keypad Emulation

This allows emulation of most other country keyboard types not listed in [Keyboard Wedge Country Types \(Country Codes\)](#) on page 9-5 in a Microsoft® operating system environment.

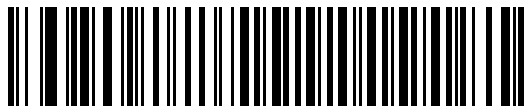

Enable Alternate Numeric Keypad

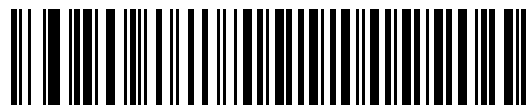

***Disable Alternate Numeric Keypad**

Caps Lock On

When enabled, the digital scanner emulates keystrokes as if the Caps Lock key is always pressed. Note that if both **Caps Lock On** and **Caps Lock Override** are enabled, **Caps Lock Override** takes precedence.

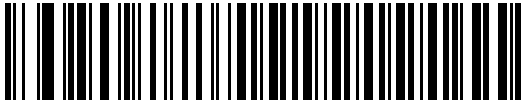

Enable Caps Lock On

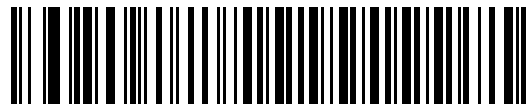

*Disable Caps Lock On

Caps Lock Override

When enabled, on AT or AT Notebook hosts, the keyboard ignores the state of the Caps Lock key. Therefore, an 'A' in the bar code is sent as an 'A' no matter what the state of the keyboard's Caps Lock key.

Note that if both **Caps Lock On** and **Caps Lock Override** are enabled, **Caps Lock Override** takes precedence.

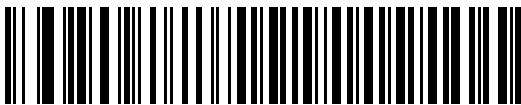

Enable Caps Lock Override



*Disable Caps Lock Override

Convert Wedge Data

When enabled, the digital scanner converts all bar code data to the selected case.



Convert to Upper Case

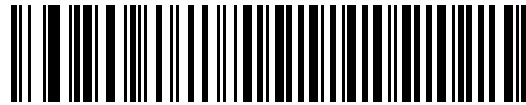

Convert to Lower Case

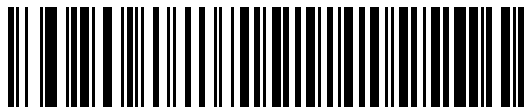

***No Convert**

Function Key Mapping

ASCII values under 32 are normally sent as control key sequences (see [Table 9-2 on page 9-13](#)). When this parameter is enabled, the keys in bold are sent in place of the standard key mapping. Table entries that do not have a bold entry remain the same whether or not this parameter is enabled.



Enable Function Key Mapping



***Disable Function Key Mapping**

FN1 Substitution

When enabled, the digital scanner replaces FN1 characters in an EAN128 bar code with a keystroke chosen by the user (see [FN1 Substitution Values on page 5-50](#)).



Enable FN1 Substitution

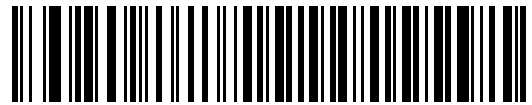

***Disable FN1 Substitution**

Send Make and Break

When enabled, the scan codes for releasing a key are not sent.

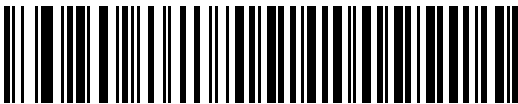

***Send Make and Break Scan Codes**

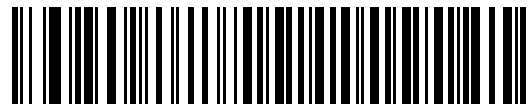

Send Make Scan Code Only

Keyboard Map

Refer to the following keyboard map for prefix/suffix keystroke parameters. To program the prefix/suffix values, see the bar codes on [page 5-48](#).

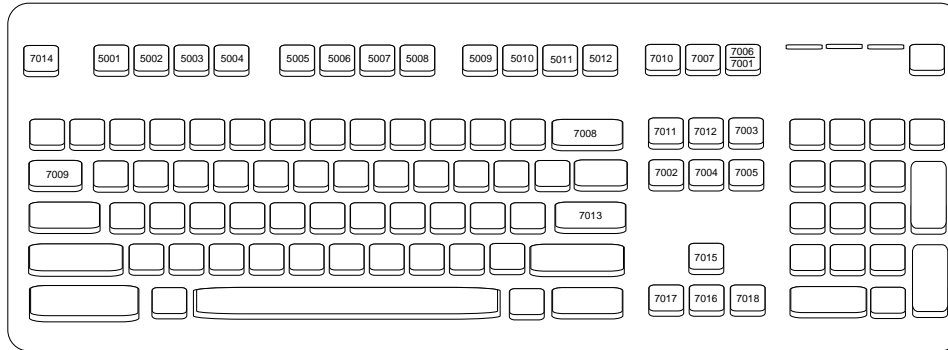

Figure 9-2 IBM PS2 Type Keyboard

ASCII Character Set for Keyboard Wedge

- ✓ **NOTE** Code 39 Full ASCII interprets the bar code special character (\$ + % /) preceding a Code 39 character and assigns an ASCII character value to the pair. For example, when Code 39 Full ASCII is enabled and a **+B** is scanned, it is interpreted as **b**, **%J** as **?**, and **%V** as **@**. Scanning **ABC%I** outputs the keystroke equivalent of **ABC >**.

Table 9-2 Keyboard Wedge ASCII Character Set

ASCII Value	Full ASCII Code 39 Encode Character	Keystroke
1001	\$A	CTRL A
1002	\$B	CTRL B
1003	\$C	CTRL C
1004	\$D	CTRL D
1005	\$E	CTRL E
1006	\$F	CTRL F
1007	\$G	CTRL G
1008	\$H	CTRL H/ BACKSPACE ¹
1009	\$I	CTRL I/ HORIZONTAL TAB ¹
1010	\$J	CTRL J
1011	\$K	CTRL K
1012	\$L	CTRL L
1013	\$M	CTRL M/ ENTER ¹
1014	\$N	CTRL N
1015	\$O	CTRL O
1016	\$P	CTRL P
1017	\$Q	CTRL Q
1018	\$R	CTRL R
1019	\$S	CTRL S
1020	\$T	CTRL T
1021	\$U	CTRL U
1022	\$V	CTRL V

¹The keystroke in bold is sent only if the "Function Key Mapping" is enabled. Otherwise, the unbolded keystroke is sent.

Table 9-2 Keyboard Wedge ASCII Character Set (Continued)

ASCII Value	Full ASCII Code 39 Encode Character	Keystroke
1023	\$W	CTRL W
1024	\$X	CTRL X
1025	\$Y	CTRL Y
1026	\$Z	CTRL Z
1027	%A	CTRL [/ESC ¹
1028	%B	CTRL \
1029	%C	CTRL]
1030	%D	CTRL 6
1031	%E	CTRL -
1032	Space	Space
1033	/A	!
1034	/B	"
1035	/C	#
1036	/D	\$
1037	/E	%
1038	/F	&
1039	/G	'
1040	/H	(
1041	/I)
1042	/J	*
1043	/K	+
1044	/L	,
1045	-	-
1046	.	.
1047	/O	/
1048	0	0
1049	1	1
1050	2	2
1051	3	3

¹The keystroke in bold is sent only if the "Function Key Mapping" is enabled. Otherwise, the unbolded keystroke is sent.

Table 9-2 Keyboard Wedge ASCII Character Set (Continued)

ASCII Value	Full ASCII Code 39 Encode Character	Keystroke
1052	4	4
1053	5	5
1054	6	6
1055	7	7
1056	8	8
1057	9	9
1058	/Z	:
1059	%F	;
1060	%G	<
1061	%H	=
1062	%I	>
1063	%J	?
1064	%V	@
1065	A	A
1066	B	B
1067	C	C
1068	D	D
1069	E	E
1070	F	F
1071	G	G
1072	H	H
1073	I	I
1074	J	J
1075	K	K
1076	L	L
1077	M	M
1078	N	N
1079	O	O
1080	P	P

¹The keystroke in bold is sent only if the "Function Key Mapping" is enabled. Otherwise, the unbolded keystroke is sent.

Table 9-2 Keyboard Wedge ASCII Character Set (Continued)

ASCII Value	Full ASCII Code 39 Encode Character	Keystroke
1081	Q	Q
1082	R	R
1083	S	S
1084	T	T
1085	U	U
1086	V	V
1087	W	W
1088	X	X
1089	Y	Y
1090	Z	Z
1091	%K	[
1092	%L	\
1093	%M]
1094	%N	^
1095	%O	_
1096	%W	'
1097	+A	a
1098	+B	b
1099	+C	c
1100	+D	d
1101	+E	e
1102	+F	f
1103	+G	g
1104	+H	h
1105	+I	i
1106	+J	j
1107	+K	k
1108	+L	l
1109	+M	m

¹The keystroke in bold is sent only if the "Function Key Mapping" is enabled. Otherwise, the unbolded keystroke is sent.

Table 9-2 Keyboard Wedge ASCII Character Set (Continued)

ASCII Value	Full ASCII Code 39 Encode Character	Keystroke
1110	+N	n
1111	+O	o
1112	+P	p
1113	+Q	q
1114	+R	r
1115	+S	s
1116	+T	t
1117	+U	u
1118	+V	v
1119	+W	w
1120	+X	x
1121	+Y	y
1122	+Z	z
1123	%P	{
1124	%Q	
1125	%R	}
1126	%S	~

¹The keystroke in bold is sent only if the "Function Key Mapping" is enabled. Otherwise, the unbolded keystroke is sent.

Table 9-3 Keyboard Wedge ALT Key Character Set

ALT Keys	Keystroke
2065	ALT A
2066	ALT B
2067	ALT C
2068	ALT D
2069	ALT E
2070	ALT F
2071	ALT G
2072	ALT H
2073	ALT I
2074	ALT J
2075	ALT K
2076	ALT L
2077	ALT M
2078	ALT N
2079	ALT O
2080	ALT P
2081	ALT Q
2082	ALT R
2083	ALT S
2084	ALT T
2085	ALT U
2086	ALT V
2087	ALT W
2088	ALT X
2089	ALT Y
2090	ALT Z

Table 9-4 *Keyboard Wedge GIU Key Character Set*

GUI Keys	Keystrokes
3000	Right Control Key
3048	GUI 0
3049	GUI 1
3050	GUI 2
3051	GUI 3
3052	GUI 4
3053	GUI 5
3054	GUI 6
3055	GUI 7
3056	GUI 8
3057	GUI 9
3065	GUI A
3066	GUI B
3067	GUI C
3068	GUI D
3069	GUI E
3070	GUI F
3071	GUI G
3072	GUI H
3073	GUI I
3074	GUI J
3075	GUI K
3076	GUI L
3077	GUI M
3078	GUI N
3079	GUI O
3080	GUI P
3081	GUI Q
3082	GUI R
3083	GUI S

Table 9-4 Keyboard Wedge GIU Key Character Set (Continued)

GUI Keys	Keystrokes
3084	GUI T
3085	GUI U
3086	GUI V
3087	GUI W
3088	GUI X
3089	GUI Y
3090	GUI Z

Table 9-5 Keyboard Wedge F Key Character Set

F Keys	Keystroke
5001	F1
5002	F2
5003	F3
5004	F4
5005	F5
5006	F6
5007	F7
5008	F8
5009	F9
5010	F10
5011	F11
5012	F12
5013	F13
5014	F14
5015	F15
5016	F16
5017	F17
5018	F18
5019	F19
5020	F20
5021	F21

Table 9-5 *Keyboard Wedge F Key Character Set (Continued)*

F Keys	Keystroke
5022	F22
5023	F23
5024	F24

Table 9-6 *Keyboard Wedge Numeric Keypad Character Set*

Numeric Keypad	Keystroke
6042	*
6043	+
6044	undefined
6045	-
6046	.
6047	/
6048	0
6049	1
6050	2
6051	3
6052	4
6053	5
6054	6
6055	7
6056	8
6057	9
6058	Enter
6059	Num Lock

Table 9-7 *Keyboard Wedge Extended Keypad Character Set*

Extended Keypad	Keystroke
7001	Break
7002	Delete
7003	Pg Up
7004	End
7005	Pg Dn
7006	Pause
7007	Scroll Lock
7008	Backspace
7009	Tab
7010	Print Screen
7011	Insert
7012	Home
7013	Enter
7014	Escape
7015	Up Arrow
7016	Dn Arrow
7017	Left Arrow
7018	Right Arrow

CHAPTER 10 IBM INTERFACE

Introduction

This chapter provides instructions for programming the cradle to interface with an IBM 468X/469X host computer.

Throughout the programming bar code menus, default values are indicated with asterisks (*).

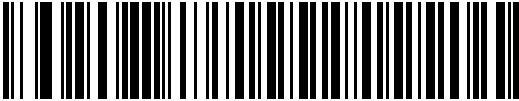

* Indicates Default — ***Disable Convert to Code 39** — Feature/Option

Connecting to an IBM 468X/469X Host

- ✓ **NOTE** See [Chapter 4, Radio Communications](#) for information about digital scanner/cradle pairing and wireless communication

The digital scanner must be connected to the cradle for the host parameter setting to take effect. When the digital scanner is not connected to a cradle, and a host parameter bar code is scanned, a long low/long high beep sequence sounds.

This connection is made directly from the cradle to the host interface.

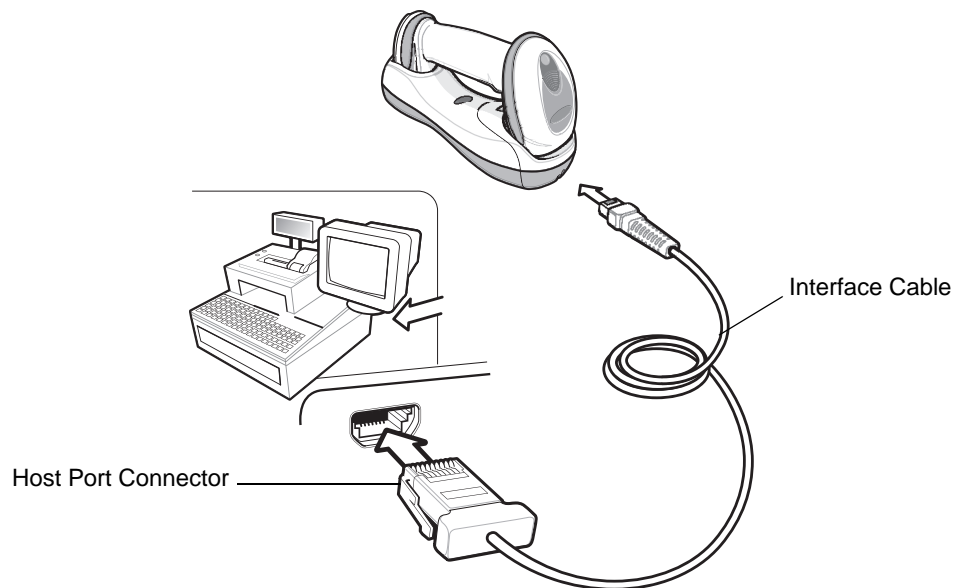

Figure 10-1 IBM Direct Connection

To connect the IBM 46XX interface:

1. Attach the modular connector of the IBM 46XX interface cable to the host port on the bottom of the digital scanner cradle (see [Connecting the Cables to the CR0078-S/CR0008-S Cradle on page 1-8](#) or [Connecting the CR0078-P Series Cradle on page 1-9](#)).
2. Connect the other end of the IBM 46XX interface cable to the appropriate port on the host (typically Port 9).
3. Select the port address by scanning the appropriate bar code from [Port Address on page 10-4](#).
4. To modify any other parameter options, scan the appropriate bar codes in this chapter.

- ✓ **NOTE** Interface cables vary depending on configuration. The connectors illustrated in [Figure 10-1](#) are examples only. The connectors may be different than those illustrated, but the steps to connect the cradle remain the same.

If a power supply is used, disconnect the power supply before changing host cables or the cradle may not recognize the new host.

The only required configuration is the port number. Other digital scanner parameters are typically controlled by the IBM system.

IBM 468X/469X Parameter Defaults

Table 10-1 lists the defaults for IBM host parameters. To change any option, scan the appropriate bar code(s) provided in the Parameter Descriptions section beginning on [page 10-4](#).



NOTE See [Appendix A, Standard Default Parameters](#) for all user preferences, hosts, symbologies, and miscellaneous default parameters.

Table 10-1 *IBM Host Default Parameters*

Parameter	Default	Page Number
IBM 468X/469X Host Parameters		
Port Address	None Selected	10-4
Convert Unknown to Code 39	Disable	10-5
Ignore Beep	Disable	10-6
Ignore Bar Code Configuration	Disable	10-6

IBM 468X/469X Host Parameters

Port Address

This parameter sets the IBM 468X/469X port used.

- ✓ **NOTE** Scanning one of these bar codes enables the RS-485 interface on the digital scanner.
- ✓ **NOTE** For a list of supported scanner functionality by communication protocol, see [Appendix G, Communication Protocol Functionality](#).

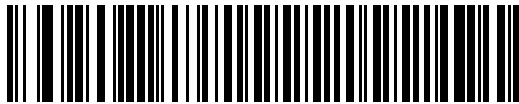

* None Selected

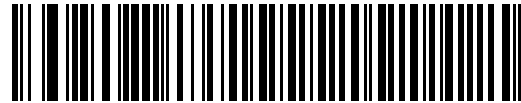

Hand-Held Scanner Emulation (Port 9B)¹

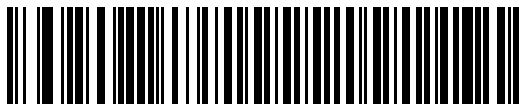

Non-IBM Scanner Emulation (Port 5B)

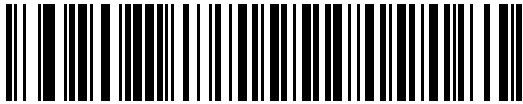

Table-Top Scanner Emulation (Port 17)

- ✓ **NOTE** ¹User selection is required to configure this interface and this is the most common selection.

Convert Unknown to Code 39

Scan a bar code below to enable or disable the conversion of unknown bar code type data to Code 39.



Enable Convert Unknown to Code 39

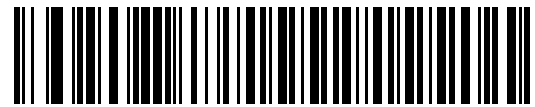

***Disable Convert Unknown to Code 39**

Optional IBM Parameters

If you configure the digital scanner and find the settings were not saved, or changed, when the system is restarted scan the bar codes that follow to override IBM interface defaults.

Scan a bar code below after setting defaults and before configuring the digital scanner.

Ignore Beep

The host can send a beep request to the digital scanner. When this parameter is enabled, the request is not sent to the attached digital scanner. All directives are still acknowledged to the IBM RS485 host as if it were processed.



***Disable**



Enable

Ignore Bar Code Configuration

The host has the ability to enable/disable code types. When this parameter is enabled, the request is not sent to the attached digital scanner. All directives are still acknowledged to the IBM RS485 host as if it were processed.



***Disable**



Enable

CHAPTER 11 WAND EMULATION INTERFACE

Introduction

This chapter provides instructions for programming the cradle to interface with a wand emulation host. This mode is used whenever wand emulation communication is needed. The digital scanner cradle connects either to an external wand decoder or to a decoder integrated in a portable terminal or Point-of-Sale (POS) terminal.

In this mode the digital scanner emulates the signal of a digital wand to make it “readable” by a wand decoder.

Throughout the programming bar code menus, default values are indicated with asterisks (*).



* Indicates Default — ***Transmit Unknown Characters** — Feature/Option

Connecting Using Wand Emulation

- ✓ **NOTE** See [Chapter 4, Radio Communications](#) for information about digital scanner/cradle pairing and wireless communication

The digital scanner must be connected to the cradle for the host parameter setting to take effect. When the digital scanner is not connected to a cradle, and a host parameter bar code is scanned, a long low/long high beep sequence sounds.

To perform Wand Emulation, connect the cradle to a portable data terminal, or a controller which collects the wand data and interprets it for the host.



IMPORTANT The CR0078-S cradle (model STB4278) supports Wand Emulation. The CR0078-P cradle (model CR0078) does not support Wand Emulation.

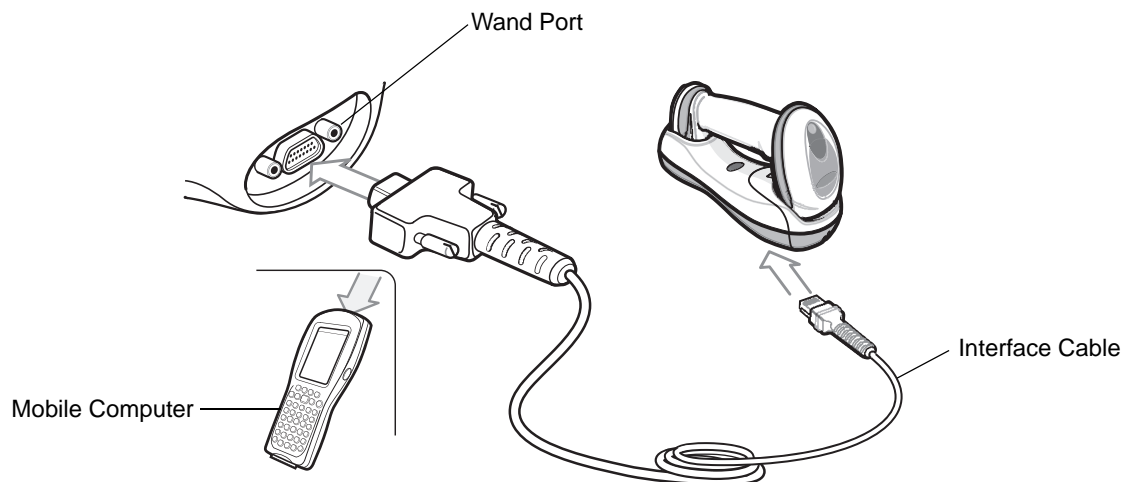

Figure 11-1 Wand Emulation Connection

To connect the Wand Emulation interface:

1. Attach the modular connector of the Wand Emulation interface cable to the host port on the bottom of the digital scanner cradle (see [Connecting the CR0078-S/CR0008-S Series Cradle on page 1-8](#)).
2. Connect the other end of the Wand Emulation interface cable to the wand port on the mobile computer or controller.
3. Select the Wand Emulation host type by scanning the appropriate bar code from [Wand Emulation Host Types on page 11-4](#).
4. To modify any other parameter options, scan the appropriate bar codes in this chapter.

- ✓ **NOTE** Interface cables vary depending on configuration. The connectors illustrated in [Figure 11-1](#) are examples only. The connectors may be different than those illustrated, but the steps to connect the cradle remain the same.

If a power supply is used, disconnect the power supply before changing host cables or the cradle may not recognize the new host.



CAUTION Connect the cradle to a 5 volt decoder only. Connecting the cradle to a 12 volt decoder can damage the digital scanner and invalidate the warranty.

Wand Emulation Parameter Defaults

Table 11-1 lists the defaults for Wand Emulation host types. To change any option, scan the appropriate bar code(s) provided in Wand Emulation Host Parameters beginning on [page 11-4](#).

✓ **NOTE** See [Appendix A, Standard Default Parameters](#) for all user preferences, hosts, symbologies, and miscellaneous default parameters.

Table 11-1 *Wand Emulation Default Parameters*

Parameter	Default	Page Number
Wand Emulation Host Parameters		
Wand Emulation Host Types	Symbol OmniLink Interface Controller ¹	11-4
Leading Margin	80 msec	11-4
Polarity	Bar High/Margin Low	11-5
Ignore Unknown Characters	Send	11-5
Convert All Bar Codes to Code 39	Disable	11-6
Convert Code 39 to Full ASCII	Disable	11-6

¹User selection is required to configure this interface and this is the most common selection.

Wand Emulation Host Parameters

Wand Emulation Host Types

Select a Wand Emulation host by scanning one of the bar codes below.



Symbol OmniLink Interface Controller¹

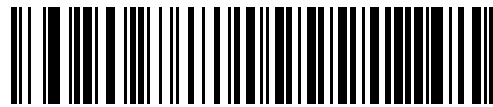

Symbol PDT Terminal (MSI)



Symbol PTC Terminal (Telxon)

¹User selection is required to configure this interface and this is the most common selection.

Leading Margin (Quiet Zone)

Scan a bar code below to select a leading margin duration. A leading margin is the time that precedes the first bar of the scan, (in milliseconds). The minimum allowed value is 80 msec and the maximum is 250 msec. This parameter accommodates older wand decoders which cannot handle short leading margins.



NOTE 250 msec is the maximum value that this parameter can attain, however, 200 msec is sufficient.

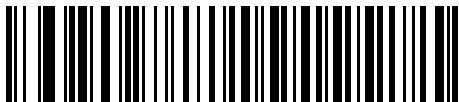

*80 msec



140 msec

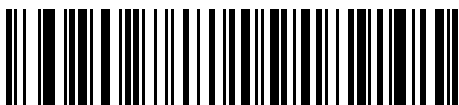

200 msec

Polarity

Scan a bar code below to select the polarity required by the decoder. Polarity determines how the cradle's Wand Emulation interface creates the Digitized Bar code Pattern (DBP). DBP is a digital signal that represents the scanned bar code. Different decoders expect the DBP to be in a certain format. The DBP either has the "highs" represent bars and the "lows" represent spaces (margins), or the "highs" represent spaces (margins) and the "lows" represent bars.

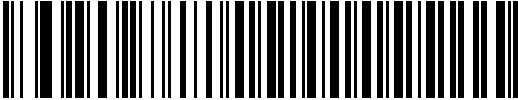

*Bar High/Margin Low

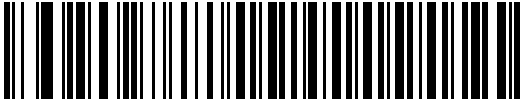

Bar Low/Margin High

Ignore Unknown Characters

Unknown characters are characters the host does not recognize. When **Send Bar Codes With Unknown Characters** is selected, all bar code data is sent except for unknown characters, and no error beeps sound on the digital scanner. When **Do Not Send Bar Codes With Unknown Characters** is selected, bar codes containing at least one unknown character are not sent to the host, and the digital scanner emits an error beep.



*Send Bar Codes With Unknown Characters



Do Not Send Bar Codes With Unknown Characters

Convert All Bar Codes to Code 39

By default, the Wand Emulation interface sends data to the attached host in the same symbology that was decoded. This can be a problem for customers with older systems that do not recognize newer symbologies (for example, GS1 DataBar).

Enabling this parameter ignores the original symbology decoded, and outputs the data as if it were a Code 39 bar code. Any lowercase characters in the original data stream are transmitted as uppercase characters. This also allows ADF rules.

If **Ignore Unknown Characters** is enabled, any characters that do not have a corresponding character in the Code 39 symbology set are replaced by a space.

If **Ignore Unknown Characters** is disabled, if any characters that do not have a corresponding character are encountered, the digital scanner emits an error beep and no data is transmitted.

✓ **NOTE** ADF Note: By default, the Wand Emulation interface does not allow scanned data to be processed by ADF rules. Enabling this parameter has the side effect of allowing the scanned data to be processed by the ADF rules (see [Chapter 16, Advanced Data Formatting](#)).

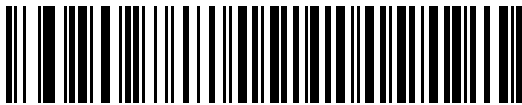

Enable Convert to Code 39 for Wand Host

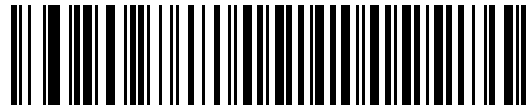

*Disable Convert to Code 39 for Wand Host

Convert Code 39 to Full ASCII

By default, any characters that do not have a corresponding character in the Code 39 symbology set are replaced by a space. If this parameter is enabled, the data sent to the wand interface is encoded in Code 39 Full ASCII. This setting requires that the host be able to interpret Code 39 Full ASCII data.

This setting applies only if **Convert to Code 39** is also enabled.

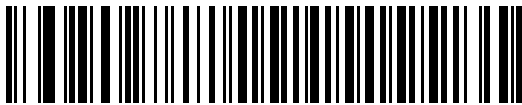

*Disable Code 39 Full ASCII Conversion



Enable Code 39 Full ASCII Conversion

CHAPTER 12 SCANNER EMULATION INTERFACE

This chapter provides instructions for programming the cradle to interface with a digital scanner emulation host. With digital scanner emulation, the cradle connects either to an external decoder or to a decoder integrated in a portable terminal or Point-of-Sale (POS) terminal.

Throughout the programming bar code menus, default values are indicated with asterisks (*).



* Indicates Default — ***Parameter Process and Pass-Through** — Feature/Option

Connecting Using Scanner Emulation

- ✓ **NOTE** See [Chapter 4, Radio Communications](#) for information about scanner/cradle pairing and wireless communication

The digital scanner must be connected to the cradle for the host parameter setting to take effect. When the digital scanner is not connected to a cradle, and a host parameter bar code is scanned, a long low/long high beep sequence sounds.

To perform Scanner Emulation, connect the cradle to a mobile computer, or a controller which collects the data and interprets it for the host.

- ⚠ **IMPORTANT** The CR0078-S cradle (model STB4278) supports Scanner Emulation. The CR0078-P cradle (model CR0078) does not support Scanner Emulation.

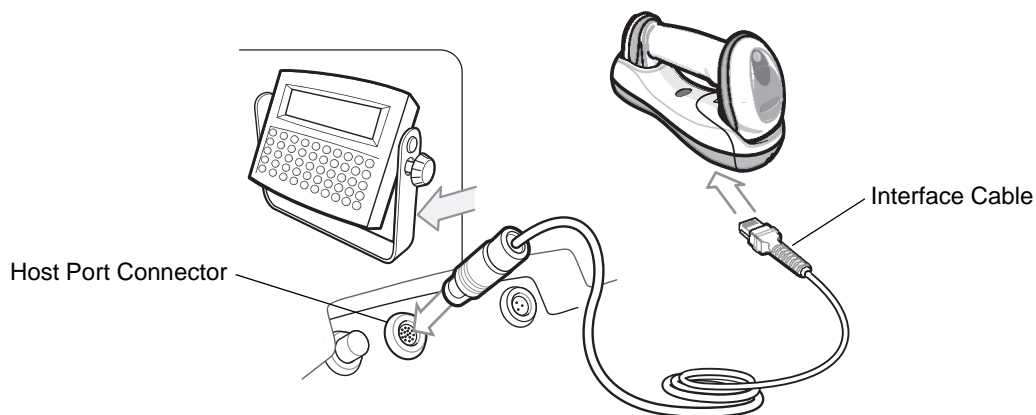

Figure 12-1 Scanner Emulation Connection

To connect the Scanner Emulation interface:

1. Attach the modular connector of the Scanner Emulation interface cable to the host port on the bottom of the digital scanner cradle (see [Connecting the Cables to the CR0078-S/CR0008-S Cradle on page 1-8](#)).
2. Connect the other end of the Scanner Emulation interface cable to the digital scanner port on the mobile computer or controller.
3. Scan the Scanner Emulation host bar code from [Scanner Emulation Host on page 12-3](#) to enable the Scanner Emulation host interface.
4. To modify any other parameter options, scan the appropriate bar codes in this chapter.

- ✓ **NOTE** Interface cables vary depending on configuration. The connectors illustrated in [Figure 12-1](#) are examples only. The connectors may be different than those illustrated, but the steps to connect the cradle remain the same.

If a power supply is used, disconnect the power supply before changing host cables or the cradle may not recognize the new host.

- ⚠ **CAUTION** Connect the cradle to a 5 volt decoder only. Connecting the cradle to a 12 volt decoder can damage the digital scanner and invalidate the warranty.

Scanner Emulation Parameter Defaults

Table 12-1 lists the defaults for the Scanner Emulation host. To change any option, scan the appropriate bar code(s) provided in the Scanner Emulation Host Parameters section beginning on [page 12-4](#).

✓ **NOTE** See [Appendix A, Standard Default Parameters](#) for all user preferences, hosts, symbologies, and miscellaneous default parameters.

Table 12-1 *Scanner Emulation Default Parameters*

Parameter	Default	Page Number
Beep Style	Beep on Successful Transmit	12-4
Parameter Pass-Through	Parameter Process and Pass Through	12-5
Convert Newer Code Types	Convert Newer Code Types	12-6
Module Width	20 μ s	12-6
Convert All Bar Codes to Code 39	Do Not Convert Bar Codes to Code 39	12-7
Code 39 Full ASCII Conversion	Disable	12-7
Transmission Timeout	3 sec	12-8
Ignore Unknown Characters	Ignore Unknown Characters	12-9
Leading Margin	2 ms	12-9
Check for Decode LED	Check for Decode LED	12-10

¹User selection is required to configure this interface and this is the most common selection.

Scanner Emulation Host

Scan the bar code below to enable the Scanner Emulation host.



Undecoded Scanner Emulation Host

Scanner Emulation Host Parameters

Beep Style

The Scanner Emulation host supports three beep styles.

- **Beep On Successful Transmit:** The digital scanner beeps when the attached decoder issues the decode signal to the digital scanner, so the digital scanner and the attached decoder beep at the same time.
- **Beep At Decode Time:** The digital scanner beeps upon decode. This results in a double beep sequence from most decoders, since the digital scanner beeps, and the decoder beeps (at a different frequency) when it successfully decodes the output.
- **Do Not Beep:** Only the attached decoder issues the decode beep.



***Beep On Successful Transmit**



Beep At Decode Time



Do Not Beep

Parameter Pass-Through

The Scanner Emulation host can process parameter bar code messages and send them to the attached decoder. In this way, customers using Symbol compliant decoders can control the behavior of the entire system by scanning the necessary parameters only once.

For example, to enable D 2 of 5, scan the **D 2 of 5 Enable** parameter bar code. The digital scanner and the attached decoder both process the parameter.



***Parameter Process and Pass-Through**



Parameter Process Only

Convert Newer Code Types

The digital scanner supports a variety of code types that are not decodable by attached decoder systems. To allow compatibility in these environments, the digital scanner converts these code types to more commonly decodable symbologies, as per the following chart. Symbologies not listed on this chart are transmitted normally.

Scan this code type:	Transmitted as:
Code 11	Code 39
Chinese 2 of 5	Code 39
GS1 DataBar (14, Limited, and Expanded)	Code 128
Coupon Code	Code 128

When decoding these code types with this parameter disabled, the digital scanner issues Convert Error beeps and transmits no data.



***Convert Newer Code Types**



Reject Newer Code Types

Module Width

The standard module width is 20 μ s. For an extremely slow decoder system, select **50 μ s Module Width**.



***20 μ s Module Width**



50 μ s Module Width

Convert All Bar Codes to Code 39

Scan the bar code below to enable or disable the conversion of all bar code data to Code 39.



***Do Not Convert Bar Codes To Code 39**



Convert All To Code 39

Code 39 Full ASCII Conversion

By default, any characters that do not have a corresponding character in the Code 39 symbology set are replaced by a space. If this parameter is enabled, the data sent to the Scanner Emulation host is encoded in Code 39 Full ASCII. The host must be able to interpret Code 39 Full ASCII data. This setting applies only if **Convert to Code 39** is also enabled.



***Disable Convert Code 39 To Full ASCII**



Enable Convert Code 39 To Full ASCII

Transmission Timeout

The Scanner Emulation host transmits bar code data to the attached decoder and waits for the decoder to assert the Decode signal, indicating successful transmission. If, after a specified amount of time, the Decode signal is not asserted (indicating that the attached decoder has not successfully received the bar code data), the digital scanner issues transmit error beeps.

Scan a bar code below to select the desired transmission timeout.



***3 Second Transmission Timeout**



4 Second Transmission Timeout



5 Second Transmission Timeout



10 Second Transmission Timeout



30 Second Transmission Timeout

Ignore Unknown Characters

Unknown characters are characters the decoder does not recognize. When **Ignore Unknown Characters** is selected, all bar code data is sent except for unknown characters, and no error beeps sound. When **Convert Error on Unknown Characters** is selected, bar codes containing at least one unknown character are not sent to the decoder, and a convert error beep sounds.



***Ignore Unknown Characters**



Convert Error On Unknown Characters

Leading Margin

Scan a bar code below to select a leading margin duration.



1 ms Leading Margin



***2 ms Leading Margin**



3 ms Leading Margin

Leading Margin (continued)



5 ms Leading Margin



10 ms Leading Margin

Check For Decode LED

The attached decoder normally asserts the Decode line to signal to the Scanner Emulation host that it successfully decoded the transmitted bar code. Some decoders, however, do not assert the Decode signal. In this case, the digital scanner emits transmit error beeps to indicate that the bar code was not successfully transmitted. Scan the **Ignore Decode LED** bar code to disable the Transmit Error beeps.



*Check For Decode LED



Ignore Decode LED

CHAPTER 13 123SCAN2

Introduction

123Scan² is an easy to use, PC-based software tool that enables rapid customized setup of Zebra scanners.

123Scan² uses a wizard tool to guide users through a streamlined set up process. Settings are saved in a configuration file that can be distributed via e-mail, electronically downloaded via a USB cable, or used to generate a sheet of scannable programming bar codes.

Additionally 123Scan² can upgrade scanner firmware, check online to enable support for newly released products, generate a collection of multi-setting bar codes if the number of settings is very large, stage a large number of scanners simultaneously, generate reports with asset tracking information, and create custom products.

Communication with 123Scan²

To communicate with the 123Scan² program which runs on a host computer running a Windows XP SP2, Windows 7 or Windows 8 operating system, use a USB cable to connect the scanner to the host computer (see [USB Connection on page 7-2](#)).

123Scan² Requirements

- Host computer with Windows XP SP2, or Windows 7
- Scanner
- USB cable.

For more information on 123Scan², go to:
<http://www.zebra.com/123Scan2>

For a 1 minute video tour of 123Scan, go to:
<http://www.zebra.com/ScannerHowToVideos>

To download 123Scan² software and access the Help file integrated in the utility, go to:
<http://www.zebra.com/123Scan2>

Scanner SDK, Other Software Tools, and Videos

Tackle all your scanner programming needs with our diversified set of software tools. Whether you need to simply stage a device, or develop a fully featured application with image and data capture as well as asset management, these tools help you every step of the way. To download any of the free tools listed below, go to: <http://www.zebra.com/scannersoftware>.

- 123Scan2 Configuration Utility (described in this chapter)
- Scanner SDK for Windows
- How-to-Videos
- Virtual COM Port Driver
- OPOS Driver
- JPOS Driver
- Scanner User Documentation.

✓ **NOTE** For a list of SDK supported scanner functionality by communication protocol, see [Appendix G, Communication Protocol Functionality](#).

See [Appendix I, Non-Parameter Attributes](#) for definitions and attribute numbers of non-parameter attributes. This appendix includes attributes electronically loaded to the scanner either by 123Scan or via SMS.

CHAPTER 14 OCR PROGRAMMING

Introduction

This chapter describes how to set up the digital scanner for OCR programming. The digital scanner can read 6 to 60 point OCR typeface. It supports font types OCR-A, OCR-B, MICR-E13B, and US Currency Serial Number.

OCR is not as secure as a bar code. To decrease OCR misdecodes and speed OCR reading, set an accurate OCR template and character subset, and use a check digit.

All OCR fonts are disabled by default. Enabling OCR can slow bar code decoding. Enabling more than one OCR font could also slow OCR decoding and impact OCR decoding accuracy.

Throughout the programming bar code menus, asterisks (*) indicate default values.



* Indicates Default — ***Disable OCR-A** — Feature/Option



NOTE Most computer monitors allow scanning the bar codes directly on the screen. When scanning from the screen, be sure to set the document magnification to a level where you can see the bar code clearly, and bars and/or spaces are not merging.

OCR Parameter Defaults

Table 14-1 lists the defaults for OCR parameters. To change any option, scan the appropriate bar code(s) provided in the Parameter Descriptions section beginning on [page 14-3](#).

✓ **NOTE** See [Appendix A, Standard Default Parameters](#) for all user preferences, hosts, symbologies, and miscellaneous default parameters.

Table 14-1 OCR Programming Default Parameters

Parameter	Parameter Number	Default	Page Number
OCR Programming Parameters			
OCR-A	680	Disable	14-3
OCR-A Variant	684	Full ASCII	14-3
OCR-B	681	Disable	14-5
OCR-B Variant	685	Full ASCII	14-6
MICR E13B	682	Disable	14-9
US Currency	683	Disable	14-10
OCR Orientation	687	0°	14-10
OCR Lines	691	1	14-12
OCR Minimum Characters	689	3	14-12
OCR Maximum Characters	690	100	14-13
OCR Security Level	554	80	14-13
OCR Subset	686	Selected font variant	14-14
OCR Quiet Zone	695	50	14-14
OCR Bright Illumination	701	Disable	14-15
OCR Template	547	54R	14-16
OCR Check Digit Modulus	688	1	14-25
OCR Check Digit Multiplier	700	121212121212	14-26
OCR Check Digit Validation	694	None	14-27
Inverse OCR	856	Regular	14-32

OCR Programming Parameters

Enable/Disable OCR-A

Parameter # 680

To enable or disable OCR-A, scan one of the following bar codes.



Enable OCR-A
(1)

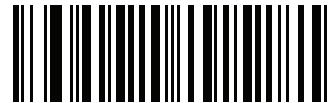

*Disable OCR-A
(0)

OCR-A Variant

Parameter # 684

Font variant sets a processing algorithm and default character subset for the given font. To choose a variant, scan one of the following bar codes. Selecting the most appropriate font variant optimizes performance and accuracy.

OCR-A supports the following variants:

- OCR-A Full ASCII
!"#\$()*+,-./0123456789<>ABCDEFGHIJKLMNOPQRSTUVWXYZ^
- OCR-A Reserved 1
\$*+,-./0123456789ABCDEFGHIJKLMNOPQRSTUVWXYZ
- OCR-A Reserved 2
\$*+,-./0123456789<>ABCDEFGHIJKLMNOPQRSTUVWXYZ
- OCR-A Banking
-0123456789<> ƒ Ɔ ʞ

Special banking characters output as the following representative characters:

ƒ outputs as f

Ɔ outputs as c

ʞ outputs as h

✓ **NOTE** Enable OCR-A before setting this parameter. If disabling OCR-A, set the variant to its default (OCR-A Full ASCII).

OCR-A Variant (continued)



***OCR-A Full ASCII
(0)**



**OCR-A Reserved 1
(1)**



**OCR-A Reserved 2
(2)**

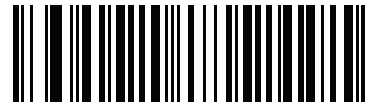

**OCR-A Banking
(3)**

Enable/Disable OCR-B

Parameter # 681

To enable or disable OCR-B, scan one of the following bar codes.



**Enable OCR-B
(1)**



***Disable OCR-B
(0)**

OCR-B Variant

Parameter # 685

OCR-B has the following variants. Selecting the most appropriate font variant affects performance and accuracy.

- OCR-B Full ASCII
!#\$%()*+,-./0123456789<>ABCDEFGHIJKLMN OPQRSTUVWXYZ^_`{|}~
- OCR-B Banking
#+-0123456789<>JNP|
- OCR-B Limited
+,-./0123456789<>ACENPSTVX
- OCR-B ISBN 10-Digit Book Numbers
-0123456789>BCEINPSXz
- OCR-B ISBN 10 or 13-Digit Book Numbers
-0123456789>BCEINPSXz
- OCR-B Travel Document Version 1 (TD1) 3-Line ID Cards
-0123456789<ABCDEFGHIJKLMN OPQRSTUVWXYZ
- OCR-B Travel Document Version 2 (TD2) 2-Line ID Cards
-0123456789<ABCDEFGHIJKLMN OPQRSTUVWXYZ
- OCR-B Travel Document 2 or 3-Line ID Cards Auto-Detect
!#\$%()*+,-./0123456789<>ABCDEFGHIJKLMN OPQRSTUVWXYZ^_`{|}~
- OCR-B Passport
-0123456789<ABCDEFGHIJKLMN OPQRSTUVWXYZÑ
- OCR-B Visa Type A
-0123456789<ABCDEFGHIJKLMN OPQRSTUVWXYZ
- OCR-B Visa Type B
-0123456789<ABCDEFGHIJKLMN OPQRSTUVWXYZÑ

To choose a variant, scan one of the following bar codes. Selecting the following OCR-B variants automatically sets the appropriate [OCR Lines on page 14-12](#). These five variants invoke extensive special algorithms and checking for that particular document type:

Variant	OCR Lines Setting
Passport	2
TD1 ID Cards	3
TD2 ID Cards	2
Visa Type A	2
Visa Type B	2

Selecting one of the ISBN Book Numbers automatically applies the appropriate ISBN checksum, so you do not need to set this.

OCR-B Variant (continued)

For the best performance in passport reading, fix the target passport and the digital scanner in place (6.5 - 7.5").

✓ **NOTE** Enable OCR-B before setting this parameter. If disabling OCR-B, set the variant to its default (OCR-B Full ASCII).



***OCR-B Full ASCII
(0)**

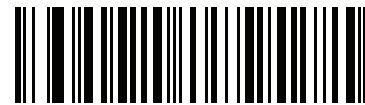

**OCR-B Banking
(1)**



**OCR-B Limited
(2)**



**OCR-B ISBN 10-Digit Book Numbers
(6)**



**OCR-B ISBN 10 or 13-Digit Book Numbers
(7)**

OCR-B Variant (continued)



**OCR-B Travel Document Version 1 (TD1)
3 Line ID Cards
(3)**



**OCR-B Travel Document Version 2 (TD2)
2-Line ID Cards
(8)**



**Travel Document 2 or 3-Line ID Cards Auto-Detect
(20)**



**OCR-B Passport
(4)**



**OCR-B Visa Type A
(9)**



**OCR-B Visa Type B
(10)**

Enable/Disable MICR E13B

Parameter # 682

To enable or disable MICR E13B, scan one of the following bar codes.

MICR E 13B uses the following characters:

0 1 2 3 4 5 6 7 8 9 : ; ' " #

TOAD characters (Transit, On Us, Amount, and Dash) output as the following representative characters:

␣ outputs as t

␣ outputs as a

␣ outputs as o

␣ outputs as d



**Enable MICR E13B
(1)**



***Disable MICR E13B
(0)**

Enable/Disable US Currency Serial Number

Parameter # 683

To enable or disable US Currency Serial Number, scan one of the following bar codes.



Enable US Currency
(1)

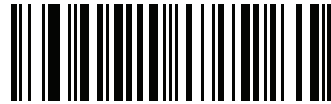

*Disable US Currency
(0)

OCR Orientation

Parameter # 687

Select one of five options to specify the orientation of an OCR string to be read:

- 0° to the imaging engine (default)
- 270° clockwise (or 90° counterclockwise) to the imaging engine
- 180° (upside down) to the imaging engine
- 90° clockwise to the imaging engine
- Omnidirectional.

Setting an incorrect orientation can cause misdecodes.

OCR Orientation (continued)

***OCR Orientation 0°
(0)**

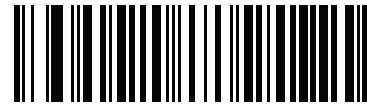

**OCR Orientation 270° Clockwise
(1)**



**OCR Orientation 180° Clockwise
(2)**



**OCR Orientation 90° Clockwise
(3)**



**OCR Orientation Omnidirectional
(4)**

OCR Lines

Parameter # 691

To select the number of OCR lines to decode, scan one of the following bar codes. Selecting Visas, Passport, TD1, or TD2 ID cards automatically sets the appropriate **OCR Lines**. Also see [OCR-B Variant on page 14-6](#).



***OCR 1 Line
(1)**



**OCR 2 Lines
(2)**



**OCR 3 Lines
(3)**

OCR Minimum Characters

Parameter # 689

To select the minimum number of OCR characters (not including spaces) per line to decode, scan the following bar code, then scan a three-digit number between 003 and 100 using the numeric keypad in [Chapter 16, Advanced Data Formatting](#) representing the number of OCR characters to decode. Strings of OCR characters less than the minimum are ignored. The default is 003.



OCR Minimum Characters

OCR Maximum Characters

Parameter # 690

To select the maximum number of OCR characters (including spaces) per line to decode, scan the following bar code, then scan a three-digit number between 003 and 100 using the numeric keypad in [Chapter 16, Advanced Data Formatting](#) represents the number of OCR characters to decode. Strings of OCR characters greater than the maximum are ignored. The default is 100.



OCR Maximum Characters

OCR Security Level

Parameter # 554

To select the OCR decoding security/confidence level, scan the following bar code, then scan a two-digit number using the numeric keypad in [Chapter 16, Advanced Data Formatting](#) represents the level of confidence. Greater numbers minimize OCR decoding errors but reduce performance. Setting a value that is too high can result in failure to decode. Setting a value that is too low can cause decoding errors. The range of the security level is 10 - 90 and the default is 80.



OCR Security Level

OCR Subset

Parameter # 686

Set an OCR subset to define a custom group of characters in place of a preset font variant. For example, if scanning only numbers and the letters A, B, and C, create a subset of just these characters to speed decoding. This applies a designated OCR Subset across all enabled OCR fonts.

To set or modify the OCR font subset, first enable the appropriate OCR font(s). Next, scan the following bar code, then scan numbers and letters to form the OCR Subset from the alphanumeric keyboard in [Chapter 16, Advanced Data Formatting](#). Then scan **End of Message** in [Chapter 16, Advanced Data Formatting](#).



OCR Subset

To cancel an OCR subset, for OCR-A or OCR-B, scan OCR-A variant **Full ASCII**, or OCR-B variant **Full ASCII**.

For MICR E13B or US Currency Serial Number, create a subset which includes all allowed characters in that character set, or scan an option from the [Default Parameters on page 5-5](#) and re-program the digital scanner.

OCR Quiet Zone

Parameter # 695

This option sets the OCR quiet zone. The digital scanner stops scanning a field when it detects a sufficiently wide blank space. The width of this space is defined by the End of Field option. Used with parsers that tolerate slanted characters, the End of Field count is roughly a count of 8 for a character width. For example if set to 15, then two character widths are an end of line indicator for the parser. Larger end of field numbers require bigger quiet zones at each end of text line.

To set a quiet zone, scan the following bar code, then scan a two-digit number using the numeric keypad in [Chapter 16, Advanced Data Formatting](#). The range of the quiet zone is 20 - 99 and the default is 50, indicating a six character width quiet zone.



OCR Quiet Zone

OCR Bright Illumination

Parameter # 701

When enabled, image contrast is improved for OCR scanning. Zebra recommends enabling this when the OCR string is longer than 20 characters, and for applications with busy backgrounds such as passport, check, or VISA reading.



**Enable OCR Bright Illumination
(1)**

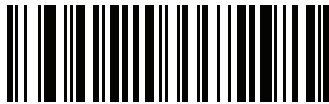

***Disable OCR Bright Illumination
(0)**



NOTE Enabling **OCR Bright Illumination** causes the aiming pattern to blink due to the lower frame rate setting.

OCR Template

Parameter # 547

This option creates a template for precisely matching scanned OCR characters to a desired input format. Carefully constructing an OCR template eliminates scanning errors.

To set or modify the OCR decode template, scan the [OCR Template](#) bar code, then bar codes corresponding to numbers and letters on the following pages to form the template expression. Then scan **End of Message** in [Chapter 16, Advanced Data Formatting](#). The default is **54R** which accepts any character OCR strings.



OCR Template



End of Message

Required Digit (9)



9

Only a numeric character is allowed in this position.

Template	Valid data	Valid data	Invalid data
99999	12987	30517	123AB

Required Alpha (A)



A

Only an alpha character is allowed in this position.

Template	Valid data	Valid data	Invalid data
AAA	ABC	WXY	12F

Require and Suppress (0)

It is required that any character in this position, including space or reject, is suppressed from the output.

Template	Incoming data	Output
990AA	12QAB	12AB

Optional Alphanumeric (1)

1

When this option appears in the template string, the data validator accepts an alphanumeric character if present. Optional characters are not allowed as the first character(s) in a field of like characters.

Template	Valid data	Valid data	Invalid data
99991	1234A	12345	1234<

Optional Alpha (2)

2

When this option appears in the template string, the data validator accepts an alpha character if present. Optional characters are not allowed as the first character(s) in a field of like characters.

Template	Valid data	Valid data	Invalid data
AAAA2	ABCDE	WXYZ	ABCD6

Alpha or Digit (3)

3

The data validator requires an alphanumeric character in this position to validate the incoming data.

Template	Valid data	Valid data	Invalid data
33333	12ABC	WXYZ34	12AB<

Any Including Space & Reject (4)

4

The template accepts any character in this position, including space and reject. Rejects are represented as an underscore (_) in the output. This is a good selection for troubleshooting.

Template	Valid data	Valid data
99499	12\$34	34_98

Any except Space & Reject (5)

5

The template accepts any character in this position except a space or reject.

Template	Valid data	Valid data	Invalid data
55999	A.123	*Z456	A BCD

Optional Digit (7)

7

When this option appears in the template string, the template accepts a numeric character if present. Optional characters are not allowed as the first character(s) in a field of like characters.

Template	Valid data	Valid data	Invalid data
99977	12345	789	789AB

Digit or Fill (8)**8**

The data validator accepts any numeric or fill character in this position.

Template	Valid data	Valid data	Invalid data
88899	12345	>>789	<<789

Alpha or Fill (F)**F**

The data validator accepts any alpha or fill character in this position.

Template	Valid data	Valid data	Invalid data
AAAFF	ABCXY	LMN>>	ABC<5

Required Space ()**Space**

When this option appears in the template string, the template accepts a space if present. Optional characters are not allowed as the first character(s) in a field of like characters.

Template	Valid data	Invalid data
99 99	12 34	67891

Optional Small Special (.)



.

When this option appears in the template string, the data validator accepts a special character if present. Optional characters are not allowed as the first character(s) in a field of like characters. Small special characters are - , and .

Template	Valid data	Valid data	Invalid data
AA.99	MN.35	XY98	XYZ12

Other Template Operators

These template operators assist in capturing, delimiting, and formatting scanned OCR data.

Literal String (" and +)



"



+

Use either of these delimiting characters surrounding characters from the alphanumeric keyboard in [Chapter 16, Advanced Data Formatting](#) to define a literal string within a template that must be present in scanned OCR data. There are two characters used to delimit required literal strings; if one of the delimiter characters is present in the desired literal string, use the other delimiter.

Template	Valid data	Invalid data
"35+BC"	35+BC	AB+22

New Line (E)**E**

To create a template of multiple lines, add **E** between the template of each single line.

Template	Valid data	Valid data	Invalid data
999EAAAA	321	987	XYZW
	BCAD	ZXYW	12

String Extract (C)**C**

This operator combined with others defines a string of characters to extract from the scanned data. The string extract is structured as follows:

CbPe

Where:

- **C** is the string extract operator
- **b** is the string begin delimiter
- **P** is the category (one or more numeric or alpha characters) describing the string representation
- **e** is the string end delimiter

Values for **b** and **e** can be any scannable character. They are included in the output stream.

Template	Incoming data	Output
C>A>	XQ3>ABCDE>	>ABCDE>
	->ATHRUZ>123	>ATHRUZ>
	1ABCXYZ	No Output

Ignore to End of Field (D)**D**

This operator causes all characters after a template to be ignored. Use this as the last character in a template expression. Examples for the template 999D:

Template	Incoming data	Output
999D	123-PED	123
	357298	357
	193	193

Skip Until (P1)**P****1**

This operator allows skipping over characters until a specific character type or a literal string is detected. It can be used in two ways:

P1ct

Where:

- P1 is the Skip Until operator
- c is the type of character that triggers the start of output
- t is one or more template characters

P1"s"t

Where:

- P1 is the Skip Until operator
- "s" is one or more literal string characters (see [Literal String \(" and +\) on page 14-20](#)) that trigger the start of output
- t is one or more template characters

The trigger character or literal string is included in output from a Skip Until operator, and the first character in the template should accommodate this trigger.

Template	Incoming data	Output
P1 "PN"AA9999	123PN9876	PN9876
	PN1234	PN1234
	X-PN3592	PN3592

Skip Until Not (P0)



P



0

This operator allows skipping over characters until a specific character type or a literal string is not matched in the output stream. It can be used in two ways:

P0ct

Where:

- P0 is the Skip Until Not operator
- c is the type of character that triggers the start of output
- t is one or more template characters

P0"s"t

Where:

- P0 is the Skip Until Not operator
- "s" is one or more literal string characters (see [Literal String \(" and +\) on page 14-20](#)) that trigger the start of output
- t is one or more template characters

The trigger character or literal string is not included in output from a Skip Until Not operator.

Template	Incoming data	Output
P0A9999	BN3456	3456
	PN1234	1234
	5341	5341

Template	Incoming data	Output
P0 "PN" 9999	PN3456	3456
	5341	5341
	PNPN7654	7654

Repeat Previous (R)



R

This operator allows a template character to repeat one or more times, allowing the capture of variable-length scanned data. The following examples capture two required alpha characters followed by one or more required digits:

Template	Incoming data	Output
AA9R	AB3	AB3
	PN12345	PN12345
	32RM52700	No output

Scroll Until Match (S)



S

This operator steps through scanned data one character at a time until the data matches the template.

Template	Incoming data	Output
S99999	AB3	No Output
	PN12345	12345
	32RM52700	52700

Multiple Templates

This feature sets up multiple templates for OCR decoding. To do this, follow the procedure described in [OCR Template on page 14-16](#) (scan the [OCR Template](#) bar code, then bar codes corresponding to numbers and letters to form the template expression, then **End of Message**) for each template in the multiple template string, using a capital letter **X** as a separator between the templates.

For example, set the [OCR Template](#) as **99999XAAAAA** to decode OCR strings of either **12345** or **ABCDE**. Up to 99 templates are permitted.

Template Examples

Following are sample templates with descriptions of valid data for each definition.

Field Definition	Description
"M"99977	M followed by three digits and two optional digits.
"X"997777"X"	X followed by two digits, four optional digits, and an X .
9959775599	Two digits followed by any character, a digit, two optional digits, any two characters, and two digits.
A55 "-"999 "-"99	A letter followed by two characters, a dash, three digits, a dash, and two digits.
33A" ."99	Two alphanumeric characters followed by a letter, a period, and two digits.
999992991	Five digits followed by an optional alpha, two digits, and an optional alphanumeric.
"PN98"	Literal field - PN98

OCR Check Digit Modulus

Parameter # 688

This option sets OCR module check digit calculation. The check digit is the last digit (in the right most position) in an OCR string and improves the accuracy of the collected data. The check digit is the end product of a calculation made on the incoming data. For check digit calculation, for example Modulus 10, alpha and numeric characters are assigned numeric weights (see [OCR Check Digit Multiplier on page 14-26](#)). The calculation is applied to the character weights and the resulting check digit is added to the end of the data. If the incoming data does not match the check digit, the data is considered corrupt.

The selected check digit option does not take effect until you set **OCR Check Digit Validation**.

To choose the Check Digit Modulus, such as 10 for modulo 10, scan the following bar code, then scan a three-digit number from 001 to 099 representing the check digit using the numeric keypad in [Chapter 16, Advanced Data Formatting](#). The default is 1.



OCR Check Digit

OCR Check Digit Multiplier

Parameter # 700

This option sets OCR check digit multipliers for the character positions. For check digit validation, each character in scanned data has an equivalent weight used in the check digit calculation. DS6878 OCR ships with the following weight equivalents:

0 = 0	A = 10	K = 20	U = 30
1 = 1	B = 11	L = 21	V = 31
2 = 2	C = 12	M = 22	W = 32
3 = 3	D = 13	N = 23	X = 33
4 = 4	E = 14	O = 24	Y = 34
5 = 5	F = 15	P = 25	Z = 35
6 = 6	G = 16	Q = 26	Space = 0
7 = 7	H = 17	R = 27	
8 = 8	I = 18	S = 28	
9 = 9	J = 19	T = 29	

All other characters are equivalent to one (1).

You can define the multiplier string if it is different from the default.

121212121212 (default)

123456789A (for ISBN, Product Add Right to Left. See [OCR Check Digit Validation on page 14-27](#))

For example:

ISBN	0	2	0	1	1	8	3	9	9	4
Multiplier	10	9	8	7	6	5	4	3	2	1
Product	0	18	0	7	6	40	12	27	18	4
Product add	0+	18+	0+	7+	6+	40+	12+	27+	18+	4= 132

ISBN uses modulo 11 for its check digit. In this case, 132 is divisible by 11, so it passes the check digit.

To set the check digit multiplier, scan the following bar code, then scan numbers and letters to form the multiplier string from the alphanumeric keyboard in [Chapter 16, Advanced Data Formatting](#). Then scan **End of Message** in the [Chapter 16, Advanced Data Formatting](#).



OCR Check Digit Multiplier

OCR Check Digit Validation

Parameter # 694

Use **OCR Check Digit Validation** to protect against scanning errors by applying a check digit validation scheme. The following is a list of options.

None

No check digit validation, indicating no check digit is applied. This is the default.



***No Check Digit
(0)**

Product Add Left to Right

Each character in the scanned data is assigned a numeric value (see [OCR Check Digit Multiplier on page 14-26](#)). Each digit representing a character in the scanned data is multiplied by its corresponding digit in the multiplier, and the sum of these products is computed. The check digit passes if this sum modulo Check Digit Modulus is zero.

Example:

Scanned data numeric value is 132456 (check digit is 6)

Check digit multiplier string is 123456

Digit	1	3	2	4	5	6
Multiplier	1	2	3	4	5	6
Product	1	6	6	16	25	36
Product add	1+	6+	6+	16+	25+	36= 90

The Check Digit Modulus is 10. It passes because 90 is divisible by 10 (the remainder is zero).



**Product Add Left to Right
(3)**

Product Add Right to Left

Each character in the scanned data is assigned a numeric value (see [OCR Check Digit Multiplier on page 14-26](#)). The check digit multiplier is reversed in order. Each value representing a character in the scanned data is multiplied by its corresponding digit in the reversed multiplier, resulting in a product for each character in the scanned data. The sum of these products is computed. The check digit passes if this sum modulo Check Digit Modulus is zero.

Example:

Scanned data numeric value is 132459 (check digit is 9)

Check digit multiplier string is 123456

Digit	1	3	2	4	5	9
Multiplier	6	5	4	3	2	1
Product	6	15	8	12	10	9
Product add	6+	15+	8+	12+	10+	9= 60

The Check Digit Modulus is 10. It passes because 60 is divisible by 10 (the remainder is 0).



**Product Add Right to Left
(1)**

Digit Add Left to Right

Each character in the scanned data is assigned a numeric value (see [OCR Check Digit Multiplier on page 14-26](#)). Each value representing a character in the scanned data is multiplied by its corresponding digit in the multiplier, resulting in a product for each character in the scanned data. The sum of each individual digit in all of the products is then calculated. The check digit passes if this sum modulo Check Digit Modulus is zero.

Example:

Scanned data numeric value is 132456 (check digit is 6)

Check digit multiplier string is 123456

Digit	1	3	2	4	5	6
Multiplier	1	2	3	4	5	6
Product	1	6	6	16	25	36
Digit add	1+	6+	6+	1+6+	2+5+	3+6= 36

The Check Digit Modulus is 12. It passes because 36 is divisible by 12 (the remainder is 0).



**Digit Add Left to Right
(4)**

Digit Add Right to Left

Each character in the scanned data is assigned a numeric value (see [OCR Check Digit Multiplier on page 14-26](#)). The check digit multiplier is reversed in order. Each value representing a character in the scanned data is multiplied by its corresponding digit in the reversed multiplier, resulting in a product for each character in the scanned data. The sum of each individual digit in all of the products is then calculated. The check digit passes if this sum modulo Check Digit Modulus is zero.

Example:

Scanned data numeric value is 132456 (check digit is 6)

Check digit multiplier string is 123456

Digit	1	3	2	4	5	6
Multiplier	6	5	4	3	2	1
Product	6	15	8	12	10	6
Digit add	6+	1+5+	8+	1+2+	1+0+	6= 30

The Check Digit Modulus is 10. It passes because 30 is divisible by 10 (the remainder is 0).



**Digit Add Right to Left
(2)**

Product Add Right to Left Simple Remainder

Each character in the scanned data is assigned a numeric value (see [OCR Check Digit Multiplier on page 14-26](#)). The check digit multiplier is reversed in order. Each value representing a character in the scanned data is multiplied by its corresponding digit in the reversed multiplier, resulting in a product for each character in the scanned data. The sum of these products **except for the check digit's product** is computed. The check digit passes if this sum modulo Check Digit Modulus is equal to the check digit's product.

Example:

Scanned data numeric value is 122456 (check digit is 6)

Check digit multiplier string is 123456

Digit	1	2	2	4	5	6
Multiplier	6	5	4	3	2	1
Product	6	10	8	12	10	6
Product add	6+	10+	8+	12+	10=	46 6

The Check Digit Modulus is 10. It passes because 46 divided by 10 leaves a remainder of 6.



Product Add Right to Left Simple Remainder
(5)

Digit Add Right To Left Simple Remainder

Each character in the scanned data is assigned a numeric value (see [OCR Check Digit Multiplier on page 14-26](#)). The check digit multiplier is reversed in order. Each value representing a character in the scanned data is multiplied by its corresponding digit in the reversed multiplier, resulting in a product for each character in the scanned data. The sum of each individual digit in all of the products **except for the check digit's product** is then calculated. The check digit passes if this sum modulo Check Digit Modulus is equal to the check digit's product.

Example:

Scanned data numeric value is 122459 (check digit is 6)

Check digit multiplier string is 123456

Digit	1	2	2	4	5	9
Multiplier	6	5	4	3	2	1
Product	6	10	8	12	10	9
Digit add	6+	1+0+	8+	1+2+	1+0=	19 9

The Check Digit Modulus is 10. It passes because 19 divided by 10 leaves a remainder of 9.



Digit Add Right to Left Simple Remainder
(6)

Health Industry - HIBCC43

This is the health industry module 43 check digit standard.



Health Industry - HIBCC43
(9)

Inverse OCR

Parameter # 856

Inverse OCR is white or light words on a black or dark background. Select an option for decoding inverse OCR:

- **Regular Only** - decode regular OCR (black on white) strings only.
- **Inverse Only** - decode inverse OCR (white on black) strings only.
- **Autodiscriminate** - decodes both regular and inverse OCR strings.



***Regular Only**
(0)



Inverse Only
(1)



Autodiscriminate
(2)

CHAPTER 15 SYMBOLOGIES

Introduction

This chapter describes symbology features and provides programming bar codes for selecting these features. Before programming, follow the instructions in [Chapter 1, Getting Started](#).

To set feature values, scan a single bar code or a short bar code sequence. The settings are stored in non-volatile memory and are preserved even when the digital scanner powers down.

✓ **NOTE** Most computer monitors allow scanning the bar codes directly on the screen. When scanning from the screen, be sure to set the document magnification to a level where you can see the bar code clearly, and bars and/or spaces do not merge.

Select a host type (see each host chapter for specific host information) after the power-up beeps sound. This is only necessary upon the first power-up when connected to a new host.

To return all features to default values, scan the [Default Parameters on page 5-5](#). Throughout the programming bar code menus, asterisks (*) indicate default values.

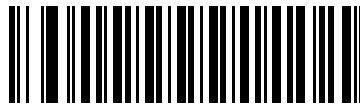

* Indicates default — *Enable UPC-A — Feature/Option
(1) — Option decimal value

Scanning Sequence Examples

In most cases, scanning one bar code sets the parameter value. For example, to transmit bar code data without the UPC-A check digit, simply scan the **Do Not Transmit UPC-A Check Digit** bar code under [Transmit UPC-A Check Digit on page 15-15](#). The digital scanner issues a fast warble beep and the LED turns green, signifying a successful parameter entry.

Other parameters, such as **Set Length(s) for D 2 of 5** require scanning several bar codes. See the individual parameter, such as **Set Length(s) for D 2 of 5**, for this procedure.

Errors While Scanning

Unless otherwise specified, to correct an error during a scanning sequence, just re-scan the correct parameter.

Symbology Parameter Defaults

[Table 15-1](#) lists the defaults for all symbologies parameters. To change the default values, scan the appropriate bar codes in this guide. These new values replace the standard default values in memory. To recall the default parameter values, scan the [Default Parameters on page 5-5](#).

✓ **NOTE** See [Appendix A, Standard Default Parameters](#) for all user preferences, hosts, and miscellaneous default parameters.

Table 15-1 Symbologies Default Parameters

Parameter	Parameter Number	Default	Page Number
UPC/EAN			
UPC-A	1	Enable	15-7
UPC-E	2	Enable	15-7
UPC-E1	12	Disable	15-8
EAN-8/JAN 8	4	Enable	15-8
EAN-13/JAN 13	3	Enable	15-9
Bookland EAN	83	Disable	15-9
Decode UPC/EAN/JAN Supplementals (2 and 5 digits)	16	Ignore	15-10
User-Programmable Supplementals			15-13
Supplemental 1:	579		
Supplemental 2:	580		
UPC/EAN/JAN Supplemental Redundancy	80	10	15-13
Decode UPC/EAN/JAN Supplemental AIM ID	672	Combined	15-14
Transmit UPC-A Check Digit	40	Enable	15-15
Transmit UPC-E Check Digit	41	Enable	15-15
Transmit UPC-E1 Check Digit	42	Enable	15-16
UPC-A Preamble	34	System Character	15-16
UPC-E Preamble	35	System Character	15-17
UPC-E1 Preamble	36	System Character	15-18
Convert UPC-E to A	37	Disable	15-19
Convert UPC-E1 to A	38	Disable	15-19

Table 15-1 Symbologies Default Parameters (Continued)

Parameter	Parameter Number	Default	Page Number
EAN-8/JAN-8 Extend	39	Disable	15-20
Bookland ISBN Format	576	ISBN-10	15-20
UCC Coupon Extended Code	85	Disable	15-21
Coupon Report	730	New Coupon Format	15-22
ISSN EAN	617	Disable	15-22
Code 128			
Code 128	8	Enable	15-23
Set Length(s) for Code 128	209, 210	Any Length	15-23
GS1-128 (formerly UCC/EAN-128)	14	Enable	15-25
ISBT 128	84	Enable	15-25
ISBT Concatenation	577	Disable	15-26
Check ISBT Table	578	Enable	15-27
ISBT Concatenation Redundancy	223	10	15-27
Code 39			
Code 39	0	Enable	15-28
Trioptic Code 39	13	Disable	15-28
Convert Code 39 to Code 32 (Italian Pharmacy Code)	86	Disable	15-29
Code 32 Prefix	231	Disable	15-29
Set Length(s) for Code 39	18, 19	2 to 55	15-30
Code 39 Check Digit Verification	48	Disable	15-31
Transmit Code 39 Check Digit	43	Disable	15-31
Code 39 Full ASCII Conversion	17	Disable	15-32
Buffer Code 39	113	Disable	15-32
Code 93			
Code 93	9	Disable	15-35
Set Length(s) for Code 93	26, 27	4 to 55	15-35
Code 11			
Code 11	10	Disable	15-37
Set Lengths for Code 11	28, 29	4 to 55	15-37
Code 11 Check Digit Verification	52	Disable	15-39

Table 15-1 *Symbologies Default Parameters (Continued)*

Parameter	Parameter Number	Default	Page Number
Transmit Code 11 Check Digit(s)	47	Disable	15-40
Interleaved 2 of 5 (ITF)			
Interleaved 2 of 5 (ITF)	6	Disable	15-41
Set Lengths for I 2 of 5	22, 23	14	15-41
I 2 of 5 Check Digit Verification	49	Disable	15-43
Transmit I 2 of 5 Check Digit	44	Disable	15-43
Convert I 2 of 5 to EAN 13	82	Disable	15-44
Discrete 2 of 5 (DTF)			
Discrete 2 of 5	5	Disable	15-44
Set Length(s) for D 2 of 5	20, 21	12	15-45
Codabar (NW - 7)			
Codabar	7	Disable	15-47
Set Lengths for Codabar	24, 25	5 to 55	15-47
CLSI Editing	54	Disable	15-49
NOTIS Editing	55	Disable	15-49
Codabar Upper or Lower Case Start/Stop Characters Transmission	855	Upper Case	15-50
MSI			
MSI	11	Disable	15-51
Set Length(s) for MSI	30, 31	4 to 55	15-51
MSI Check Digits	50	One	15-53
Transmit MSI Check Digit	46	Disable	15-53
MSI Check Digit Algorithm	51	Mod 10/Mod 10	15-54
Chinese 2 of 5			
Chinese 2 of 5	408	Disable	15-54
Matrix 2 of 5			
Matrix 2 of 5	618	Disable	15-55
Matrix 2 of 5 Lengths	619, 620	1 Length - 14	15-56
Matrix 2 of 5 Check Digit	622	Disable	15-57
Transmit Matrix 2 of 5 Check Digit	623	Disable	15-57

Table 15-1 Symbologies Default Parameters (Continued)

Parameter	Parameter Number	Default	Page Number
Korean 3 of 5			
Korean 3 of 5	581	Disable	15-58
Inverse 1D			
Inverse 1D	586	Regular	15-59
Postal Codes			
US Postnet	89	Disable	15-60
US Planet	90	Disable	15-60
Transmit US Postal Check Digit	95	Enable	15-61
UK Postal	91	Disable	15-61
Transmit UK Postal Check Digit	96	Enable	15-62
Japan Postal	290	Disable	15-62
Australia Post	291	Disable	15-63
Australia Post Format	718	Autodiscriminate	15-64
Netherlands KIX Code	326	Disable	15-65
USPS 4CB/One Code/Intelligent Mail	592	Disable	15-65
UPU FICS Postal	611	Disable	15-66
GS1 DataBar			
GS1 DataBar-14	338	Enable	15-67
GS1 DataBar Limited Non-Healthcare Configurations Healthcare Configurations	339	Disable Enable	15-67
GS1 DataBar Expanded	340	Enable	15-68
GS1 DataBar Limited Security Level	728	Level 3	15-69
Convert GS1 DataBar to UPC/EAN	397	Disable	15-70
Composite			
Composite CC-C Non-Healthcare Configurations Healthcare Configurations	341	Disable Enable	15-71
Composite CC-A/B Non-Healthcare Configurations Healthcare Configurations	342	Disable Enable	15-71
Composite TLC-39	371	Disable	15-72
UPC Composite Mode	344	Never Linked	15-72

Table 15-1 *Symbologies Default Parameters (Continued)*

Parameter	Parameter Number	Default	Page Number
Composite Beep Mode Non-Healthcare Configurations	398	Beep As Each Code Type is Decoded	15-73
Healthcare Configurations		Single Beep After Both are Decoded	
GS1-128 Emulation Mode for UCC/EAN Composite Codes	427	Disable	15-73
2D Symbologies			
PDF417	15	Enable	15-74
MicroPDF417	227	Disable	15-74
Code 128 Emulation	123	Disable	15-75
Data Matrix	292	Enable	15-76
Data Matrix Inverse Non-Healthcare Configurations Healthcare Configurations	588	Regular	15-76
		Inverse Autodetect	
Maxicode	294	Disable	15-77
QR Code	293	Enable	15-77
QR Inverse	587	Regular	15-78
MicroQR	573	Enable	15-78
Aztec	574	Enable	15-79
Aztec Inverse	589	Regular	15-79
Symbology-Specific Security Levels			
Redundancy Level	78	1	15-80
Security Level	77	1	15-82
Intercharacter Gap Size	381	Normal	15-83
Report Version			15-83
Macro PDF			
Flush Macro PDF Buffer	None	None	15-84
Abort Macro PDF Entry	None	None	15-84

UPC/EAN

Enable/Disable UPC-A

Parameter # 1

To enable or disable UPC-A, scan the appropriate bar code below.



*Enable UPC-A
(1)



Disable UPC-A
(0)

Enable/Disable UPC-E

Parameter # 2

To enable or disable UPC-E, scan the appropriate bar code below.



*Enable UPC-E
(1)



Disable UPC-E
(0)

Enable/Disable UPC-E1

Parameter # 12

UPC-E1 is disabled by default.

To enable or disable UPC-E1, scan the appropriate bar code below.

✓ **NOTE** UPC-E1 is not a UCC (Uniform Code Council) approved symbology.

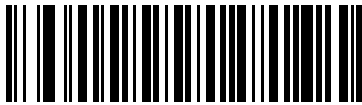

Enable UPC-E1
(1)

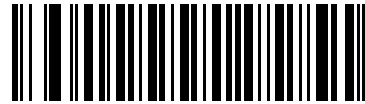

*Disable UPC-E1
(0)

Enable/Disable EAN-8/JAN-8

Parameter # 4

To enable or disable EAN-8/JAN-8, scan the appropriate bar code below.

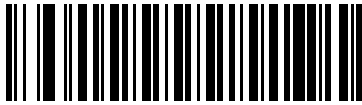

*Enable EAN-8/JAN-8
(1)

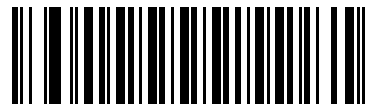

Disable EAN-8/JAN-8
(0)

Enable/Disable EAN-13/JAN-13

Parameter # 3

To enable or disable EAN-13/JAN-13, scan the appropriate bar code below.



*Enable EAN-13/JAN-13
(1)

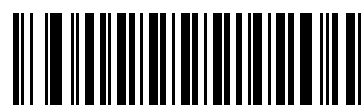

Disable EAN-13/JAN-13
(0)

Enable/Disable Bookland EAN

Parameter # 83

To enable or disable Bookland EAN, scan the appropriate bar code below.

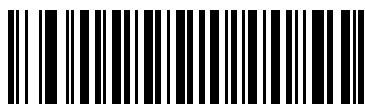

Enable Bookland EAN
(1)

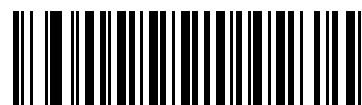

*Disable Bookland EAN
(0)



NOTE If you enable Bookland EAN, select a [Bookland ISBN Format on page 15-20](#). Also select either Decode UPC/EAN Supplementals, Autodiscriminate UPC/EAN Supplementals, or Enable 978/979 Supplemental Mode in [Decode UPC/EAN/JAN Supplementals on page 15-10](#).

Decode UPC/EAN/JAN Supplementals

Parameter # 16

Supplementals are bar codes appended according to specific format conventions (e.g., UPC A+2, UPC E+2, EAN 13+2). The following options are available:

- If you select **Ignore UPC/EAN with Supplementals**, and the digital scanner is presented with a UPC/EAN plus supplemental symbol, the digital scanner decodes UPC/EAN and ignores the supplemental characters.
- If you select **Decode UPC/EAN with Supplementals**, the digital scanner only decodes UPC/EAN symbols with supplemental characters, and ignores symbols without supplementals.
- If you select **Autodiscriminate UPC/EAN Supplementals**, the digital scanner decodes UPC/EAN symbols with supplemental characters immediately. If the symbol does not have a supplemental, the digital scanner must decode the bar code the number of times set via [UPC/EAN/JAN Supplemental Redundancy on page 15-13](#) before transmitting its data to confirm that there is no supplemental.
- If you select one of the following **Supplemental Mode** options, the digital scanner immediately transmits EAN-13 bar codes starting with that prefix that have supplemental characters. If the symbol does not have a supplemental, the digital scanner must decode the bar code the number of times set via [UPC/EAN/JAN Supplemental Redundancy on page 15-13](#) before transmitting its data to confirm that there is no supplemental. The digital scanner transmits UPC/EAN bar codes that do not have that prefix immediately.
 - **Enable 378/379 Supplemental Mode**
 - **Enable 978/979 Supplemental Mode**

✓ **NOTE** If you select 978/979 Supplemental Mode and are scanning Bookland EAN bar codes, see [Enable/Disable Bookland EAN on page 15-9](#) to enable Bookland EAN, and select a format using [Bookland ISBN Format on page 15-20](#).

- **Enable 977 Supplemental Mode**
- **Enable 414/419/434/439 Supplemental Mode**
- **Enable 491 Supplemental Mode**
- **Enable Smart Supplemental Mode** - applies to EAN-13 bar codes starting with any prefix listed previously.
- **Supplemental User-Programmable Type 1** - applies to EAN-13 bar codes starting with a 3-digit user-defined prefix. Set this 3-digit prefix using [User-Programmable Supplementals on page 15-13](#).
- **Supplemental User-Programmable Type 1 and 2** - applies to EAN-13 bar codes starting with either of two 3-digit user-defined prefixes. Set the 3-digit prefixes using [User-Programmable Supplementals on page 15-13](#).
- **Smart Supplemental Plus User-Programmable 1** - applies to EAN-13 bar codes starting with any prefix listed previously or the user-defined prefix set using [User-Programmable Supplementals on page 15-13](#).
- **Smart Supplemental Plus User-Programmable 1 and 2** - applies to EAN-13 bar codes starting with any prefix listed previously or one of the two user-defined prefixes set using [User-Programmable Supplementals on page 15-13](#).

✓ **NOTE** To minimize the risk of invalid data transmission, select either to decode or ignore supplemental characters.

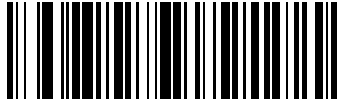
Decode UPC/EAN/JAN Supplementals (continued)

**Decode UPC/EAN/JAN Only With Supplementals
(1)**



***Ignore Supplementals
(0)**



**Autodiscriminate UPC/EAN/JAN Supplementals
(2)**

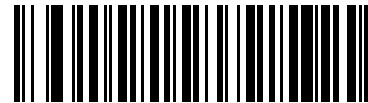

**Enable 378/379 Supplemental Mode
(4)**



**Enable 978/979 Supplemental Mode
(5)**



**Enable 977 Supplemental Mode
(7)**

Decode UPC/EAN/JAN Supplementals (continued)



Enable 414/419/434/439 Supplemental Mode
(6)



Enable 491 Supplemental Mode
(8)



Enable Smart Supplemental Mode
(3)



Supplemental User-Programmable Type 1
(9)



Supplemental User-Programmable Type 1 and 2
(10)



Smart Supplemental Plus User-Programmable 1
(11)



Smart Supplemental Plus User-Programmable 1 and 2
(12)

User-Programmable Supplementals

Supplemental 1: Parameter # 579

Supplemental 2: Parameter # 580

If you selected a Supplemental User-Programmable option from [Decode UPC/EAN/JAN Supplementals on page 15-10](#), select **User-Programmable Supplemental 1** to set the 3-digit prefix. Then select the 3 digits using the numeric bar codes beginning on [page D-1](#). Select **User-Programmable Supplemental 2** to set a second 3-digit prefix. Then select the 3 digits using the numeric bar codes beginning on [page D-1](#).



User-Programmable Supplemental 1



User-Programmable Supplemental 2

UPC/EAN/JAN Supplemental Redundancy

Parameter # 80

If you selected **Autodiscriminate UPC/EAN/JAN Supplementals**, this option adjusts the number of times to decode a symbol without supplementals before transmission. The range is from two to thirty times. Five or above is recommended when decoding a mix of UPC/EAN/JAN symbols with and without supplementals. The default is 10.

Scan the bar code below to set a decode redundancy value. Next, scan two numeric bar codes in [Appendix D, Numeric Bar Codes](#). Enter a leading zero for single digit numbers. To correct an error or change a selection, scan [Cancel on page D-2](#).



UPC/EAN/JAN Supplemental Redundancy

UPC/EAN/JAN Supplemental AIM ID Format

Parameter # 672

Select an output format when reporting UPC/EAN/JAN bar codes with supplementals with AIM ID enabled:

- **Separate** - UPC/EAN with supplementals transmit as]E<0 or 4><data>]E<1 or 2>[supp data]
- **Combined** - EAN-8 with supplementals transmit as]E4<data>]E<1 or 2>[supp data]
All other UPC/EAN with supplementals transmit as]E3<data+supps>
- **Separate Transmissions** - transmit UPC/EAN with supplementals with separate AIM IDs and separate transmissions, i.e.:
]E<0 or 4><data>
]E<1 or 2>[supplemental data]

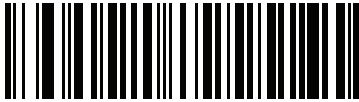

Separate
(0)



***Combined**
(1)



Separate Transmissions
(2)

Transmit UPC-A Check Digit

Parameter # 40

The check digit is the last character of the symbol used to verify the integrity of the data. Scan the appropriate bar code below to transmit the bar code data with or without the UPC-A check digit. It is always verified to guarantee the integrity of the data.

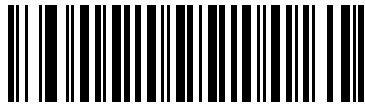

*Transmit UPC-A Check Digit
(1)

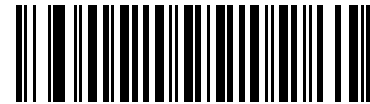

Do Not Transmit UPC-A Check Digit
(0)

Transmit UPC-E Check Digit

Parameter # 41

The check digit is the last character of the symbol used to verify the integrity of the data. Scan the appropriate bar code below to transmit the bar code data with or without the UPC-E check digit. It is always verified to guarantee the integrity of the data.

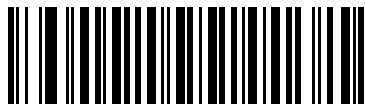

*Transmit UPC-E Check Digit
(1)

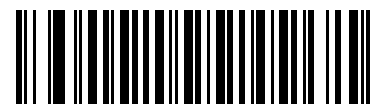

Do Not Transmit UPC-E Check Digit
(0)

Transmit UPC-E1 Check Digit

Parameter # 42

The check digit is the last character of the symbol used to verify the integrity of the data. Scan the appropriate bar code below to transmit the bar code data with or without the UPC-E1 check digit. It is always verified to guarantee the integrity of the data.

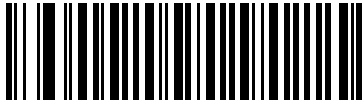

***Transmit UPC-E1 Check Digit
(1)**

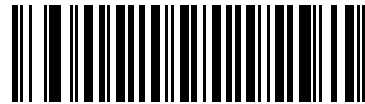

**Do Not Transmit UPC-E1 Check Digit
(0)**

UPC-A Preamble

Parameter # 34

Preamble characters are part of the UPC symbol, and include Country Code and System Character. There are three options for transmitting a UPC-A preamble to the host device: transmit System Character only, transmit System Character and Country Code ("0" for USA), and transmit no preamble. Select the appropriate option to match the host system.

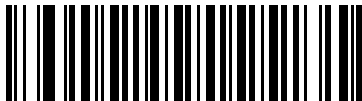

**No Preamble (<DATA>
(0)**

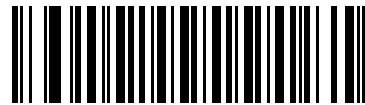

***System Character (<SYSTEM CHARACTER> <DATA>
(1)**

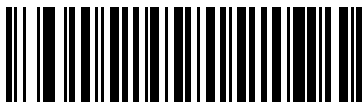

**System Character & Country Code
(< COUNTRY CODE> <SYSTEM CHARACTER> <DATA>
(2)**

UPC-E Preamble

Parameter # 35

Preamble characters are part of the UPC symbol, and include Country Code and System Character. There are three options for transmitting a UPC-E preamble to the host device: transmit System Character only, transmit System Character and Country Code ("0" for USA), and transmit no preamble. Select the appropriate option to match the host system.

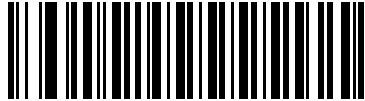

No Preamble (<DATA>)
(0)



*System Character (<SYSTEM CHARACTER> <DATA>)
(1)

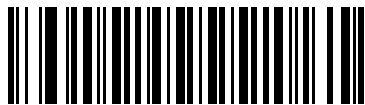

System Character & Country Code
(< COUNTRY CODE> <SYSTEM CHARACTER> <DATA>)
(2)

UPC-E1 Preamble

Parameter # 36

Preamble characters are part of the UPC symbol, and include Country Code and System Character. There are three options for transmitting a UPC-E1 preamble to the host device: transmit System Character only, transmit System Character and Country Code ("0" for USA), and transmit no preamble. Select the appropriate option to match the host system.

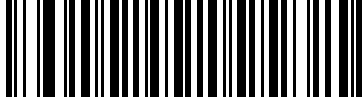

No Preamble (<DATA>)
(0)

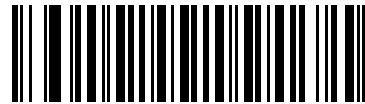

*System Character (<SYSTEM CHARACTER> <DATA>)
(1)

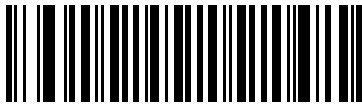

System Character & Country Code
(< COUNTRY CODE> <SYSTEM CHARACTER> <DATA>)
(2)

Convert UPC-E to UPC-A

Parameter # 37

Enable this to convert UPC-E (zero suppressed) decoded data to UPC-A format before transmission. After conversion, the data follows UPC-A format and is affected by UPC-A programming selections (e.g., Preamble, Check Digit).

Disable this to transmit UPC-E decoded data as UPC-E data, without conversion.

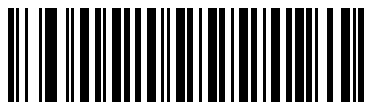

Convert UPC-E to UPC-A (Enable)
(1)

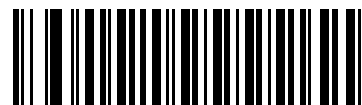

*Do Not Convert UPC-E to UPC-A (Disable)
(0)

Convert UPC-E1 to UPC-A

Parameter # 38

Enable this to convert UPC-E1 decoded data to UPC-A format before transmission. After conversion, the data follows UPC-A format and is affected by UPC-A programming selections (e.g., Preamble, Check Digit).

Disable this to transmit UPC-E1 decoded data as UPC-E1 data, without conversion.

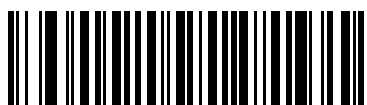

Convert UPC-E1 to UPC-A (Enable)
(1)

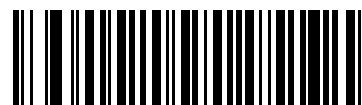

*Do Not Convert UPC-E1 to UPC-A (Disable)
(0)

EAN-8/JAN-8 Extend

Parameter # 39

Enable this parameter to add five leading zeros to decoded EAN-8 symbols to make them compatible in format to EAN-13 symbols.

Disable this to transmit EAN-8 symbols as is.

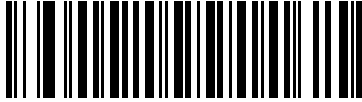

Enable EAN/JAN Zero Extend
(1)

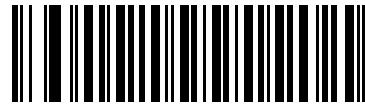

*Disable EAN/JAN Zero Extend
(0)

Bookland ISBN Format

Parameter # 576

If you enabled Bookland EAN using [Enable/Disable Bookland EAN on page 15-9](#), select one of the following formats for Bookland data:

- **Bookland ISBN-10** - The digital scanner reports Bookland data starting with 978 in traditional 10-digit format with the special Bookland check digit for backward-compatibility. Data starting with 979 is not considered Bookland in this mode.
- **Bookland ISBN-13** - The digital scanner reports Bookland data (starting with either 978 or 979) as EAN-13 in 13-digit format to meet the 2007 ISBN-13 protocol.



*Bookland ISBN-10
(0)



Bookland ISBN-13
(1)



NOTE For Bookland EAN to function properly, first enable Bookland EAN using [Enable/Disable Bookland EAN on page 15-9](#), then select either Decode UPC/EAN Supplementals, Autodiscriminate UPC/EAN Supplementals, or Enable 978/979 Supplemental Mode in [Decode UPC/EAN/JAN Supplementals on page 15-10](#).

UCC Coupon Extended Code

Parameter # 85

Enable this parameter to decode UPC-A bar codes starting with digit '5', EAN-13 bar codes starting with digit '99', and UPC-A/GS1-128 Coupon Codes. UPCA, EAN-13, and GS1-128 must be enabled to scan all types of Coupon Codes.



Enable UCC Coupon Extended Code
(1)



*Disable UCC Coupon Extended Code
(0)



NOTE See [UPC/EAN/JAN Supplemental Redundancy on page 15-13](#) to control autodiscrimination of the GS1-128 (right half) of a coupon code.

Coupon Report

Parameter # 730

Select an option to determine which type of coupon format to support.

- Select **Old Coupon Format** to support UPC-A/GS1-128 and EAN-13/GS1-128.
- Select **New Coupon Format** as an interim format to support UPC-A/GS1-DataBar and EAN-13/GS1-DataBar.
- If you select **Autodiscriminate Format**, the digital scanner supports both **Old Coupon Format** and **New Coupon Format**.



Old Coupon Format
(0)

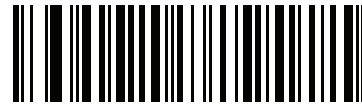

*New Coupon Format
(1)



Autodiscriminate Coupon Format
(2)

ISSN EAN

Parameter # 617

To enable or disable ISSN EAN, scan the appropriate bar code below.



Enable ISSN EAN
(1)



*Disable ISSN EAN
(0)

Code 128

Enable/Disable Code 128

Parameter # 8

To enable or disable Code 128, scan the appropriate bar code below.

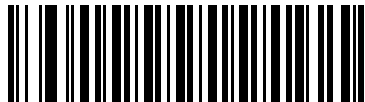

*Enable Code 128
(1)

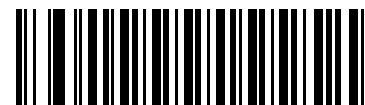

Disable Code 128
(0)

Set Lengths for Code 128

Parameter # L1 = 209, L2 = 210

The length of a code refers to the number of characters (i.e., human readable characters), including check digit(s) the code contains. Set lengths for Code 128 to any length, one or two discrete lengths, or lengths within a specific range.

✓ **NOTE** When setting lengths for different bar code types, enter a leading zero for single digit numbers.

- **One Discrete Length** - Select this option to decode only Code 128 symbols containing a selected length. Select the length using the numeric bar codes in [Appendix D, Numeric Bar Codes](#). For example, to decode only Code 128 symbols with 14 characters, scan **Code 128 - One Discrete Length**, then scan 1 followed by 4. To correct an error or change the selection, scan [Cancel on page D-2](#).
- **Two Discrete Lengths** - Select this option to decode only Code 128 symbols containing either of two selected lengths. Select lengths using the numeric bar codes in [Appendix D, Numeric Bar Codes](#). For example, to decode only Code 128 symbols containing either 2 or 14 characters, select **Code 128 - Two Discrete Lengths**, then scan 0, 2, 1, and then 4. To correct an error or change the selection, scan [Cancel on page D-2](#).
- **Length Within Range** - Select this option to decode a Code 128 symbol with a specific length range. Select lengths using numeric bar codes in [Appendix D, Numeric Bar Codes](#). For example, to decode Code 128 symbols containing between 4 and 12 characters, first scan **Code 128 - Length Within Range**. Then scan 0, 4, 1, and 2 (enter a leading zero for single digit numbers). To correct an error or change the selection, scan [Cancel on page D-2](#).
- **Any Length** - Select this option to decode Code 128 symbols containing any number of characters within the digital scanner's capability.

Set Lengths for Code 128 (continued)

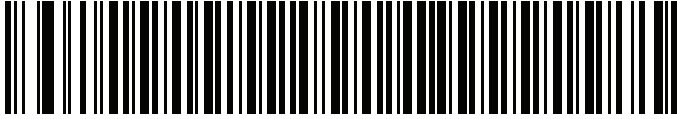

Code 128 - One Discrete Length

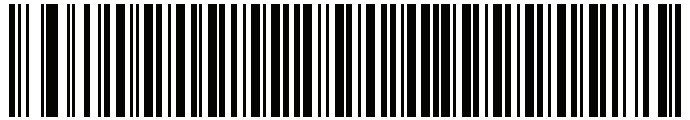

Code 128 - Two Discrete Lengths

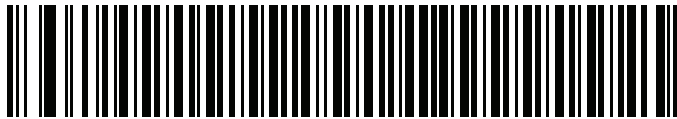

Code 128 - Length Within Range

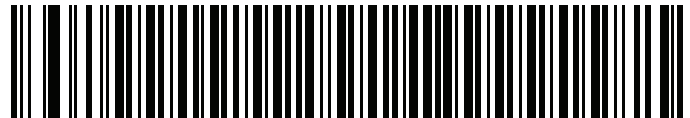

*Code 128 - Any Length

Enable/Disable GS1-128 (formerly UCC/EAN-128)

Parameter # 14

To enable or disable GS1-128, scan the appropriate bar code below.

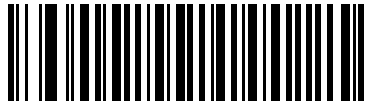

***Enable GS1-128
(1)**

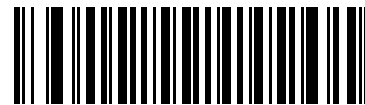

**Disable GS1-128
(0)**

Enable/Disable ISBT 128

Parameter # 84

ISBT 128 is a variant of Code 128 used in the blood bank industry. Scan a bar code below to enable or disable ISBT 128. If necessary, the host must perform concatenation of the ISBT data.



***Enable ISBT 128
(1)**

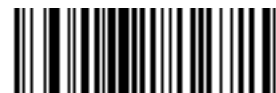

**Disable ISBT 128
(0)**

ISBT Concatenation

Parameter # 577

Select an option for concatenating pairs of ISBT code types:

- If you select **Disable ISBT Concatenation**, the digital scanner does not concatenate pairs of ISBT codes it encounters.
- If you select **Enable ISBT Concatenation**, there must be two ISBT codes in order for the digital scanner to decode and perform concatenation. The digital scanner does not decode single ISBT symbols.
- If you select **Autodiscriminate ISBT Concatenation**, the digital scanner decodes and concatenates pairs of ISBT codes immediately. If only a single ISBT symbol is present, the digital scanner must decode the symbol the number of times set via [ISBT Concatenation Redundancy on page 15-27](#) before transmitting its data to confirm that there is no additional ISBT symbol.

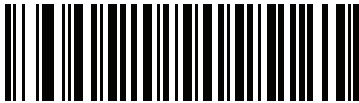

*Disable ISBT Concatenation
(0)

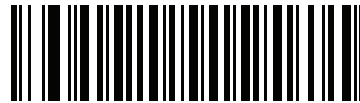

Enable ISBT Concatenation
(1)



Autodiscriminate ISBT Concatenation
(2)

Check ISBT Table

Parameter # 578

The ISBT specification includes a table that lists several types of ISBT bar codes that are commonly used in pairs. If you set **ISBT Concatenation** to **Enable**, enable **Check ISBT Table** to concatenate only those pairs found in this table. Other types of ISBT codes are not concatenated.



*Enable Check ISBT Table
(1)



Disable Check ISBT Table
(0)

ISBT Concatenation Redundancy

Parameter # 223

If you set **ISBT Concatenation** to **Autodiscriminate**, use this parameter to set the number of times the digital scanner must decode an ISBT symbol before determining that there is no additional symbol.

Scan the bar code below, then scan two numeric bar codes in [Appendix D, Numeric Bar Codes](#) to set a value between 2 and 20. Enter a leading zero for single digit numbers. To correct an error or change a selection, scan [Cancel on page D-2](#). The default is 10.



ISBT Concatenation Redundancy

Code 39

Enable/Disable Code 39

Parameter # 0

To enable or disable Code 39, scan the appropriate bar code below.

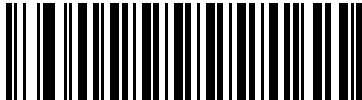

***Enable Code 39**
(1)



Disable Code 39
(0)

Enable/Disable Trioptic Code 39

Parameter # 13

Trioptic Code 39 is a variant of Code 39 used in the marking of computer tape cartridges. Trioptic Code 39 symbols always contain six characters. To enable or disable Trioptic Code 39, scan the appropriate bar code below.



Enable Trioptic Code 39
(1)



***Disable Trioptic Code 39**
(0)



NOTE You cannot enable Trioptic Code 39 and Code 39 Full ASCII simultaneously.

Convert Code 39 to Code 32

Parameter # 86

Code 32 is a variant of Code 39 used by the Italian pharmaceutical industry. Scan the appropriate bar code below to enable or disable converting Code 39 to Code 32.

✓ **NOTE** Code 39 must be enabled for this parameter to function.

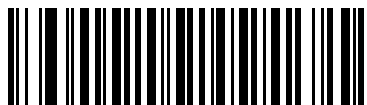

Enable Convert Code 39 to Code 32
(1)

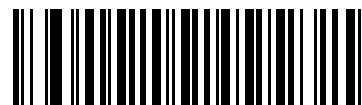

*Disable Convert Code 39 to Code 32
(0)

Code 32 Prefix

Parameter # 231

Scan the appropriate bar code below to enable or disable adding the prefix character "A" to all Code 32 bar codes.

✓ **NOTE** Convert Code 39 to Code 32 must be enabled for this parameter to function.

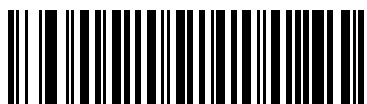

Enable Code 32 Prefix
(1)

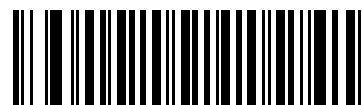

*Disable Code 32 Prefix
(0)

Set Lengths for Code 39

Parameter # L1 = 18, L2 = 19

The length of a code refers to the number of characters (i.e., human readable characters), including check digit(s) the code contains. Set lengths for Code 39 to any length, one or two discrete lengths, or lengths within a specific range. If Code 39 Full ASCII is enabled, **Length Within a Range** or **Any Length** are the preferred options.

✓ **NOTE** When setting lengths for different bar code types, enter a leading zero for single digit numbers.

- **One Discrete Length** - Select this option to decode only Code 39 symbols containing a selected length. Select the length using the numeric bar codes in [Appendix D, Numeric Bar Codes](#). For example, to decode only Code 39 symbols with 14 characters, scan **Code 39 - One Discrete Length**, then scan **1** followed by **4**. To correct an error or change the selection, scan [Cancel on page D-2](#).
- **Two Discrete Lengths** - Select this option to decode only Code 39 symbols containing either of two selected lengths. Select lengths using the numeric bar codes in [Appendix D, Numeric Bar Codes](#). For example, to decode only Code 39 symbols containing either 2 or 14 characters, select **Code 39 - Two Discrete Lengths**, then scan **0, 2, 1**, and then **4**. To correct an error or change the selection, scan [Cancel on page D-2](#).
- **Length Within Range** - Select this option to decode a Code 39 symbol with a specific length range. Select lengths using numeric bar codes in [Appendix D, Numeric Bar Codes](#). For example, to decode Code 39 symbols containing between 4 and 12 characters, first scan **Code 39 - Length Within Range**. Then scan **0, 4, 1**, and **2** (enter a leading zero for single digit numbers). To correct an error or change the selection, scan [Cancel on page D-2](#).
- **Any Length** - Select this option to decode Code 39 symbols containing any number of characters within the digital scanner's capability.



Code 39 - One Discrete Length



Code 39 - Two Discrete Lengths



Code 39 - Length Within Range



Code 39 - Any Length

Code 39 Check Digit Verification

Parameter # 48

Enable this feature to check the integrity of all Code 39 symbols to verify that the data complies with specified check digit algorithm. Only Code 39 symbols which include a modulo 43 check digit are decoded. Enable this feature if the Code 39 symbols contain a Modulo 43 check digit.

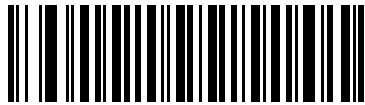

Enable Code 39 Check Digit
(1)

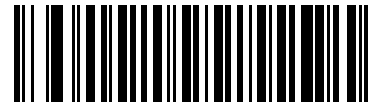

*Disable Code 39 Check Digit
(0)

Transmit Code 39 Check Digit

Parameter # 43

Scan a bar code below to transmit Code 39 data with or without the check digit.

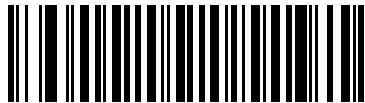

Transmit Code 39 Check Digit (Enable)
(1)



*Do Not Transmit Code 39 Check Digit (Disable)
(0)



NOTE Code 39 Check Digit Verification must be enabled for this parameter to function.

Code 39 Full ASCII Conversion

Parameter # 17

Code 39 Full ASCII is a variant of Code 39 which pairs characters to encode the full ASCII character set. To enable or disable Code 39 Full ASCII, scan the appropriate bar code below.

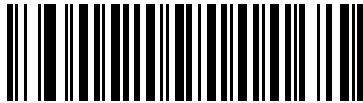

Enable Code 39 Full ASCII
(1)

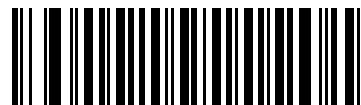

*Disable Code 39 Full ASCII
(0)



NOTE You cannot enable Trioptic Code 39 and Code 39 Full ASCII simultaneously.

Code 39 Full ASCII to Full ASCII Correlation is host-dependent, and is therefore described in the ASCII Character Set Table for the appropriate interface. See the [ASCII Character Set for USB on page 7-19](#) or the [ASCII Character Set for RS-232 on page 8-18](#).

Code 39 Buffering - Scan & Store

Parameter # 113

This feature allows the digital scanner to accumulate data from multiple Code 39 symbols.

Selecting the Scan and Store option (Buffer Code 39) temporarily buffers all Code 39 symbols having a leading space as a first character for later transmission. The leading space is not buffered.

Decoding a Code 39 symbol with no leading space transmits in sequence all buffered data in a first-in first-out format, plus the “triggering” symbol. See the following pages for further details.

Select **Do Not Buffer Code 39** to transmit all decoded Code 39 symbols immediately without storing them in the buffer.

Code 39 Buffering - Scan & Store (continued)

This feature affects Code 39 only. If selecting **Buffer Code 39**, we recommend configuring the digital scanner to decode Code 39 symbology only.



Buffer Code 39 (Enable)
(1)



***Do Not Buffer Code 39 (Disable)**
(0)

While there is data in the transmission buffer, you cannot select **Do Not Buffer Code 39**. The buffer holds 200 bytes of information.

To disable Code 39 buffering when there is data in the transmission buffer, first force the buffer transmission (see [Transmit Buffer on page 15-34](#)) or clear the buffer.

Buffer Data

To buffer data, enable Code 39 buffering and scan a Code 39 symbol with a space immediately following the start pattern.

- Unless the data overflows the transmission buffer, the digital scanner issues a low/high beep to indicate successful decode and buffering. (For overflow conditions, see [Overfilling Transmission Buffer on page 15-34](#).)
- The digital scanner adds the decoded data excluding the leading space to the transmission buffer.
- No transmission occurs.

Clear Transmission Buffer

To clear the transmission buffer, scan the **Clear Buffer** bar code below, which contains only a start character, a dash (minus), and a stop character.

- The digital scanner issues a short high/low/high beep.
- The digital scanner erases the transmission buffer.
- No transmission occurs.



Clear Buffer

✓ **NOTE** The Clear Buffer contains only the dash (minus) character. In order to scan this command, set Code 39 lengths to include length 1.

Transmit Buffer

There are two methods to transmit the Code 39 buffer.

1. Scan the **Transmit Buffer** bar code below, which includes only a start character, a plus (+), and a stop character.
2. The digital scanner transmits and clears the buffer.
 - The digital scanner issues a low/high beep.



Transmit Buffer

3. Scan a Code 39 bar code with a leading character other than a space.
 - The digital scanner appends new decode data to buffered data.
 - The digital scanner transmits and clears the buffer.
 - The digital scanner signals that it transmitted the buffer with a low/high beep.
 - The digital scanner transmits and clears the buffer.

✓ **NOTE** The Transmit Buffer contains only a plus (+) character. In order to scan this command, set Code 39 lengths to include length 1.

Overfilling Transmission Buffer

The Code 39 buffer holds 200 characters. If the symbol just read overflows the transmission buffer:

- The digital scanner indicates that it rejected the symbol by issuing three long, high beeps.
- No transmission occurs. The data in the buffer is not affected.

Attempt to Transmit an Empty Buffer

If you scan the **Transmit Buffer** symbol and the Code 39 buffer is empty:

- A short low/high/low beep signals that the buffer is empty.
- No transmission occurs.
- The buffer remains empty.

Code 93

Enable/Disable Code 93

Parameter # 9

To enable or disable Code 93, scan the appropriate bar code below.



Enable Code 93
(1)



*Disable Code 93
(0)

Set Lengths for Code 93

Parameter # L1 = 26, L2 = 27

The length of a code refers to the number of characters (i.e., human readable characters), including check digit(s) the code contains. Set lengths for Code 93 to any length, one or two discrete lengths, or lengths within a specific range.

- One Discrete Length** - Select this option to decode only Code 93 symbols containing a selected length. Select the length using the numeric bar codes in [Appendix D, Numeric Bar Codes](#). For example, to decode only Code 93 symbols with 14 characters, scan **Code 93 - One Discrete Length**, then scan **1** followed by **4**. To correct an error or to change the selection, scan [Cancel on page D-2](#).
- Two Discrete Lengths** - Select this option to decode only Code 93 symbols containing either of two selected lengths. Select lengths using the numeric bar codes in [Appendix D, Numeric Bar Codes](#). For example, to decode only Code 93 symbols containing either 2 or 14 characters, select **Code 93 - Two Discrete Lengths**, then scan **0, 2, 1**, and then **4**. To correct an error or to change the selection, scan [Cancel on page D-2](#).
- Length Within Range** - Select this option to decode a Code 93 symbol with a specific length range. Select lengths using the numeric bar codes in [Appendix D, Numeric Bar Codes](#). For example, to decode Code 93 symbols containing between 4 and 12 characters, first scan **Code 93 - Length Within Range**. Then scan **0, 4, 1**, and **2** (enter a leading zero for single digit numbers). To correct an error or change the selection, scan [Cancel on page D-2](#).
- Any Length** - Scan this option to decode Code 93 symbols containing any number of characters within the digital scanner's capability.

Set Lengths for Code 93 (continued)



Code 93 - One Discrete Length



Code 93 - Two Discrete Lengths



Code 93 - Length Within Range



Code 93 - Any Length

Code 11

Code 11

Parameter # 10

To enable or disable Code 11, scan the appropriate bar code below.



Enable Code 11
(1)



*Disable Code 11
(0)

Set Lengths for Code 11

Parameter # L1 = 28, L2 = 29

The length of a code refers to the number of characters (i.e., human readable characters), including check digit(s) the code contains. Set lengths for Code 11 to any length, one or two discrete lengths, or lengths within a specific range.

- One Discrete Length** - Select this option to decode only Code 11 symbols containing a selected length. Select the length using the numeric bar codes in [Appendix D, Numeric Bar Codes](#). For example, to decode only Code 11 symbols with 14 characters, scan **Code 11 - One Discrete Length**, then scan **1** followed by **4**. To correct an error or to change the selection, scan [Cancel on page D-2](#).
- Two Discrete Lengths** - Select this option to decode only Code 11 symbols containing either of two selected lengths. Select lengths using the numeric bar codes in [Appendix D, Numeric Bar Codes](#). For example, to decode only Code 11 symbols containing either 2 or 14 characters, select **Code 11 - Two Discrete Lengths**, then scan **0, 2, 1**, and then **4**. To correct an error or to change the selection, scan [Cancel on page D-2](#).
- Length Within Range** - Select this option to decode a Code 11 symbol with a specific length range. Select lengths using numeric bar codes in [Appendix D, Numeric Bar Codes](#). For example, to decode Code 11 symbols containing between 4 and 12 characters, first scan **Code 11 - Length Within Range**. Then scan **0, 4, 1**, and **2** (enter a leading zero for single digit numbers). To correct an error or change the selection, scan [Cancel on page D-2](#).
- Any Length** - Scan this option to decode Code 11 symbols containing any number of characters within the digital scanner's capability.

Set Lengths for Code 11 (continued)



Code 11 - One Discrete Length



Code 11 - Two Discrete Lengths



Code 11 - Length Within Range



Code 11 - Any Length

Code 11 Check Digit Verification

Parameter # 52

This feature allows the digital scanner to check the integrity of all Code 11 symbols to verify that the data complies with the specified check digit algorithm. This selects the check digit mechanism for the decoded Code 11 bar code. The options are to check for one check digit, check for two check digits, or disable the feature.

To enable this feature, scan the bar code below corresponding to the number of check digits encoded in the Code 11 symbols.

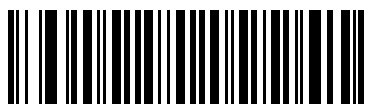

*Disable
(0)

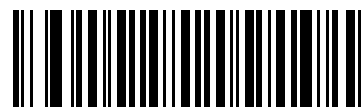

One Check Digit
(1)



Two Check Digits
(2)

Transmit Code 11 Check Digits

Parameter # 47

This feature selects whether or not to transmit the Code 11 check digit(s).



Transmit Code 11 Check Digit(s) (Enable)
(1)

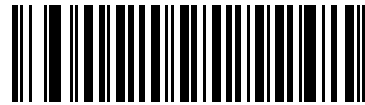

*Do Not Transmit Code 11 Check Digit(s) (Disable)
(0)



NOTE Code 11 Check Digit Verification must be enabled for this parameter to function.

Interleaved 2 of 5 (ITF)

Enable/Disable Interleaved 2 of 5

Parameter # 6

To enable or disable Interleaved 2 of 5, scan the appropriate bar code below, and select an Interleaved 2 of 5 length from the following pages.

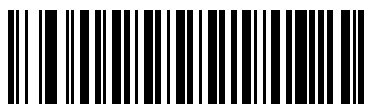

Enable Interleaved 2 of 5
(1)



*Disable Interleaved 2 of 5
(0)

Set Lengths for Interleaved 2 of 5

Parameter # L1 = 22, L2 = 23

The length of a code refers to the number of characters (i.e., human readable characters), including check digit(s) the code contains. Set lengths for I 2 of 5 to any length, one or two discrete lengths, or lengths within a specific range. The range for Interleaved 2 of 5 lengths is 0 - 55.

- **One Discrete Length** - Select this option to decode only I 2 of 5 symbols containing a selected length. Select the length using the numeric bar codes in [Appendix D, Numeric Bar Codes](#). For example, to decode only I 2 of 5 symbols with 14 characters, scan **I 2 of 5 - One Discrete Length**, then scan **1** followed by **4**. To correct an error or to change the selection, scan [Cancel on page D-2](#).
- **Two Discrete Lengths** - Select this option to decode only I 2 of 5 symbols containing either of two selected lengths. Select lengths using the numeric bar codes in [Appendix D, Numeric Bar Codes](#). For example, to decode only I 2 of 5 symbols containing either 2 or 14 characters, select **I 2 of 5 - Two Discrete Lengths**, then scan **0, 2, 1**, and then **4**. To correct an error or to change the selection, scan [Cancel on page D-2](#).
- **Length Within Range** - Select this option to decode an I 2 of 5 symbol with a specific length range. Select lengths using numeric bar codes in [Appendix D, Numeric Bar Codes](#). For example, to decode I 2 of 5 symbols containing between 4 and 12 characters, first scan **I 2 of 5 - Length Within Range**. Then scan **0, 4, 1**, and **2** (enter a leading zero for single digit numbers). To correct an error or change the selection, scan [Cancel on page D-2](#).
- **Any Length** - Scan this option to decode I 2 of 5 symbols containing any number of characters within the digital scanner's capability.

✓ **NOTE** Due to the construction of the I 2 of 5 symbology, it is possible for a scan line covering only a portion of the code to transmit as a complete scan, yielding less data than is encoded in the bar code. To prevent this, select specific lengths (I 2 of 5 - One Discrete Length, Two Discrete Lengths) for I 2 of 5 applications.

Set Lengths for Interleaved 2 of 5 (continued)



I 2 of 5 - One Discrete Length



I 2 of 5 - Two Discrete Lengths



I 2 of 5 - Length Within Range



I 2 of 5 - Any Length

I 2 of 5 Check Digit Verification

Parameter # 49

Enable this feature to check the integrity of all I 2 of 5 symbols to verify the data complies with either the specified Uniform Symbology Specification (USS), or the Optical Product Code Council (OPCC) check digit algorithm.



*Disable
(0)



USS Check Digit
(1)



OPCC Check Digit
(2)

Transmit I 2 of 5 Check Digit

Parameter # 44

Scan the appropriate bar code below to transmit I 2 of 5 data with or without the check digit.

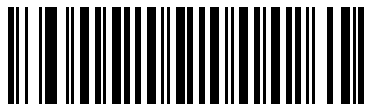

Transmit I 2 of 5 Check Digit (Enable)
(1)

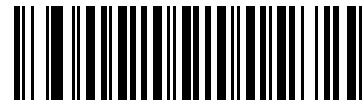

*Do Not Transmit I 2 of 5 Check Digit (Disable)
(0)

Convert I 2 of 5 to EAN-13

Parameter # 82

Enable this parameter to convert 14-character I 2 of 5 codes to EAN-13, and transmit to the host as EAN-13. To accomplish this, the I 2 of 5 code must be enabled, and the code must have a leading zero and a valid EAN-13 check digit.

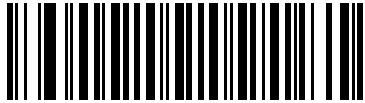

Convert I 2 of 5 to EAN-13 (Enable)
(1)



*Do Not Convert I 2 of 5 to EAN-13 (Disable)
(0)

Discrete 2 of 5 (DTF)

Enable/Disable Discrete 2 of 5

Parameter # 5

To enable or disable Discrete 2 of 5, scan the appropriate bar code below.



Enable Discrete 2 of 5
(1)



*Disable Discrete 2 of 5
(0)

Set Lengths for Discrete 2 of 5

Parameter # L1 = 20, L2 = 21

The length of a code refers to the number of characters (i.e., human readable characters), including check digit(s) the code contains. Set lengths for D 2 of 5 to any length, one or two discrete lengths, or lengths within a specific range. The range for Discrete 2 of 5 lengths is 0 - 55.

- **One Discrete Length** - Select this option to decode only D 2 of 5 symbols containing a selected length. Select the length using the numeric bar codes in [Appendix D, Numeric Bar Codes](#). For example, to decode only D 2 of 5 symbols with 14 characters, scan **D 2 of 5 - One Discrete Length**, then scan **1** followed by **4**. To correct an error or to change the selection, scan [Cancel on page D-2](#).
- **Two Discrete Lengths** - Select this option to decode only D 2 of 5 symbols containing either of two selected lengths. Select lengths using the numeric bar codes in [Appendix D, Numeric Bar Codes](#). For example, to decode only D 2 of 5 symbols containing either 2 or 14 characters, select **D 2 of 5 - Two Discrete Lengths**, then scan **0, 2, 1**, and then **4**. To correct an error or to change the selection, scan [Cancel on page D-2](#).
- **Length Within Range** - Select this option to decode a D 2 of 5 symbol with a specific length range. Select lengths using numeric bar codes in [Appendix D, Numeric Bar Codes](#). For example, to decode D 2 of 5 symbols containing between 4 and 12 characters, first scan **D 2 of 5 - Length Within Range**. Then scan **0, 4, 1**, and **2** (enter a leading zero for single digit numbers). To correct an error or change the selection, scan [Cancel on page D-2](#).
- **Any Length** - Scan this option to decode D 2 of 5 symbols containing any number of characters within the digital scanner's capability.

✓ **NOTE** Due to the construction of the D 2 of 5 symbology, it is possible for a scan line covering only a portion of the code to transmit as a complete scan, yielding less data than is encoded in the bar code. To prevent this, select specific lengths (**D 2 of 5 - One Discrete Length, Two Discrete Lengths**) for D 2 of 5 applications.

Set Lengths for Discrete 2 of 5 (continued)



D 2 of 5 - One Discrete Length



D 2 of 5 - Two Discrete Lengths



D 2 of 5 - Length Within Range



D 2 of 5 - Any Length

Codabar (NW - 7)

Enable/Disable Codabar

Parameter # 7

To enable or disable Codabar, scan the appropriate bar code below.



Enable Codabar
(1)



*Disable Codabar
(0)

Set Lengths for Codabar

Parameter # L1 = 24, L2 = 25

The length of a code refers to the number of characters (i.e., human readable characters), including check digit(s) the code contains. Set lengths for Codabar to any length, one or two discrete lengths, or lengths within a specific range.

- **One Discrete Length** - Select this option to decode only Codabar symbols containing a selected length. Select the length using the numeric bar codes in [Appendix D, Numeric Bar Codes](#). For example, to decode only Codabar symbols with 14 characters, scan **Codabar - One Discrete Length**, then scan **1** followed by **4**. To correct an error or to change the selection, scan [Cancel on page D-2](#).
- **Two Discrete Lengths** - Select this option to decode only Codabar symbols containing either of two selected lengths. Select lengths using the numeric bar codes in [Appendix D, Numeric Bar Codes](#). For example, to decode only Codabar symbols containing either 2 or 14 characters, select **Codabar - Two Discrete Lengths**, then scan **0, 2, 1**, and then **4**. To correct an error or to change the selection, scan [Cancel on page D-2](#).
- **Length Within Range** - Select this option to decode a Codabar symbol with a specific length range. Select lengths using numeric bar codes in [Appendix D, Numeric Bar Codes](#). For example, to decode Codabar symbols containing between 4 and 12 characters, first scan **Codabar - Length Within Range**. Then scan **0, 4, 1**, and **2** (enter a leading zero for single digit numbers). To correct an error or change the selection, scan [Cancel on page D-2](#).
- **Any Length** - Scan this option to decode Codabar symbols containing any number of characters within the digital scanner's capability.

Set Lengths for Codabar (continued)



Codabar - One Discrete Length



Codabar - Two Discrete Lengths



Codabar - Length Within Range



Codabar - Any Length

CLSI Editing

Parameter # 54

Enable this parameter to strip the start and stop characters and insert a space after the first, fifth, and tenth characters of a 14-character Codabar symbol. Enable this feature if the host system requires this data format.

✓ **NOTE** Symbol length does not include start and stop characters.

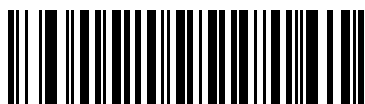

Enable CLSI Editing
(1)



*Disable CLSI Editing
(0)

NOTIS Editing

Parameter # 55

Enable this parameter to strip the start and stop characters from a decoded Codabar symbol. Enable this feature if the host system requires this data format.



Enable NOTIS Editing
(1)



*Disable NOTIS Editing
(0)

Codabar Upper or Lower Case Start/Stop Characters Transmission

Parameter # 855

Select whether to transmit upper case or lower case Codabar start/stop characters.



*Upper Case
(0)



Lower Case
(1)

MSI

Enable/Disable MSI

Parameter # 11

To enable or disable MSI, scan the appropriate bar code below.

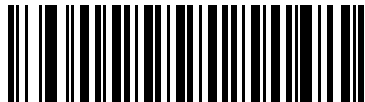

Enable MSI
(1)



*Disable MSI
(0)

Set Lengths for MSI

Parameter # L1 = 30, L2 = 31

The length of a code refers to the number of characters (i.e., human readable characters), including check digit(s) the code contains. Set lengths for MSI to any length, one or two discrete lengths, or lengths within a specific range.

- One Discrete Length** - Select this option to decode only MSI symbols containing a selected length. Select the length using the numeric bar codes in [Appendix D, Numeric Bar Codes](#). For example, to decode only MSI symbols with 14 characters, scan **MSI - One Discrete Length**, then scan **1** followed by **4**. To correct an error or to change the selection, scan [Cancel on page D-2](#).
- Two Discrete Lengths** - Select this option to decode only MSI symbols containing either of two selected lengths. Select lengths using the numeric bar codes in [Appendix D, Numeric Bar Codes](#). For example, to decode only MSI symbols containing either 2 or 14 characters, select **MSI - Two Discrete Lengths**, then scan **0, 2, 1**, and then **4**. To correct an error or to change the selection, scan [Cancel on page D-2](#).
- Length Within Range** - Select this option to decode a MSI symbol with a specific length range. Select lengths using numeric bar codes in [Appendix D, Numeric Bar Codes](#). For example, to decode MSI symbols containing between 4 and 12 characters, first scan **MSI - Length Within Range**. Then scan **0, 4, 1**, and **2** (enter a leading zero for single digit numbers). To correct an error or change the selection, scan [Cancel on page D-2](#).
- Any Length** - Scan this option to decode MSI symbols containing any number of characters within the digital scanner's capability.

Set Lengths for MSI (continued)

- ✓ **NOTE** Due to the construction of the MSI symbology, it is possible for a scan line covering only a portion of the code to transmit as a complete scan, yielding less data than is encoded in the bar code. To prevent this, select specific lengths (**MSI - One Discrete Length**, **Two Discrete Lengths**) for MSI applications.

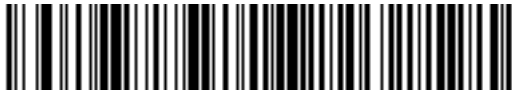

MSI - One Discrete Length



MSI - Two Discrete Lengths

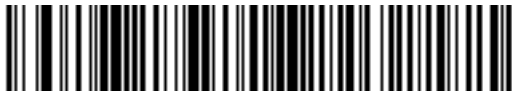

MSI - Length Within Range



MSI - Any Length

MSI Check Digits

Parameter # 50

With MSI symbols, one check digit is mandatory and always verified by the reader. The second check digit is optional. If the MSI codes include two check digits, scan the **Two MSI Check Digits** bar code to enable verification of the second check digit.

See [MSI Check Digit Algorithm on page 15-54](#) for the selection of second digit algorithms.

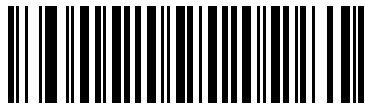

*One MSI Check Digit
(0)

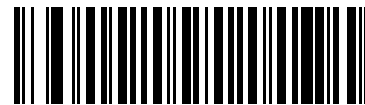

Two MSI Check Digits
(1)

Transmit MSI Check Digit(s)

Parameter # 46

Scan a bar code below to transmit MSI data with or without the check digit.

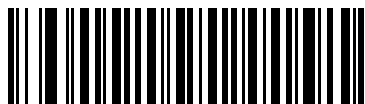

Transmit MSI Check Digit(s) (Enable)
(1)

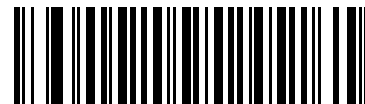

*Do Not Transmit MSI Check Digit(s) (Disable)
(0)

MSI Check Digit Algorithm

Parameter # 51

Two algorithms are possible for the verification of the second MSI check digit. Select the bar code below corresponding to the algorithm used to encode the check digit.

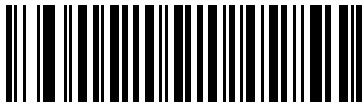

MOD 10/MOD 11
(0)

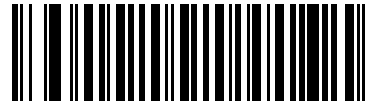

*MOD 10/MOD 10
(1)

Chinese 2 of 5

Enable/Disable Chinese 2 of 5

Parameter # 408

To enable or disable Chinese 2 of 5, scan the appropriate bar code below.



Enable Chinese 2 of 5
(1)

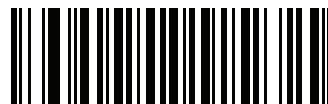

*Disable Chinese 2 of 5
(0)

Matrix 2 of 5

Enable/Disable Matrix 2 of 5

Parameter # 618

To enable or disable Matrix 2 of 5, scan the appropriate bar code below.



Enable Matrix 2 of 5
(1)



*Disable Matrix 2 of 5
(0)

Set Lengths for Matrix 2 of 5

Parameter # L1 = 619, L2 = 620

The length of a code refers to the number of characters (i.e., human readable characters), including check digit(s) the code contains. Set lengths for Matrix 2 of 5 to any length, one or two discrete lengths, or lengths within a specific range.

- **One Discrete Length** - Select this option to decode only Matrix 2 of 5 symbols containing a selected length. Select the length using the numeric bar codes in [Appendix D, Numeric Bar Codes](#). For example, to decode only Matrix 2 of 5 symbols with 14 characters, scan **Matrix 2 of 5 - One Discrete Length**, then scan **1** followed by **4**. To correct an error or to change the selection, scan [Cancel on page D-2](#).
- **Two Discrete Lengths** - Select this option to decode only Matrix 2 of 5 symbols containing either of two selected lengths. Select lengths using the numeric bar codes in [Appendix D, Numeric Bar Codes](#). For example, to decode only Matrix 2 of 5 symbols containing either 2 or 14 characters, select **Matrix 2 of 5 - Two Discrete Lengths**, then scan **0, 2, 1**, and then **4**. To correct an error or to change the selection, scan [Cancel on page D-2](#).
- **Length Within Range** - Select this option to decode a Matrix 2 of 5 symbol with a specific length range. Select lengths using the numeric bar codes in [Appendix D, Numeric Bar Codes](#). For example, to decode Matrix 2 of 5 symbols containing between 4 and 12 characters, first scan **Matrix 2 of 5 - Length Within Range**. Then scan **0, 4, 1**, and **2** (enter a leading zero for single digit numbers). To correct an error or change the selection, scan [Cancel on page D-2](#).
- **Any Length** - Scan this option to decode Matrix 2 of 5 symbols containing any number of characters within the digital scanner's capability.



*Matrix 2 of 5 - One Discrete Length



Matrix 2 of 5 - Two Discrete Lengths

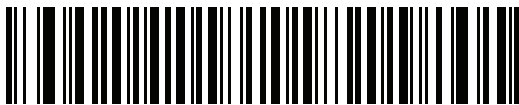

Matrix 2 of 5 - Length Within Range



Matrix 2 of 5 - Any Length

Matrix 2 of 5 Check Digit

Parameter # 622

The check digit is the last character of the symbol used to verify the integrity of the data. Scan the appropriate bar code below to transmit the bar code data with or without the Matrix 2 of 5 check digit.



Enable Matrix 2 of 5 Check Digit
(1)



*Disable Matrix 2 of 5 Check Digit
(0)

Transmit Matrix 2 of 5 Check Digit

Parameter # 623

Scan a bar code below to transmit Matrix 2 of 5 data with or without the check digit.



Transmit Matrix 2 of 5 Check Digit
(1)



*Do Not Transmit Matrix 2 of 5 Check Digit
(0)

Korean 3 of 5

Enable/Disable Korean 3 of 5

Parameter # 581

To enable or disable Korean 3 of 5, scan the appropriate bar code below.

✓ **NOTE** The length for Korean 3 of 5 is fixed at 6.



**Enable Korean 3 of 5
(1)**



***Disable Korean 3 of 5
(0)**

Inverse 1D

Parameter # 586

This parameter sets the 1D inverse decoder setting. Options are:

- **Regular Only** - the digital scanner decodes regular 1D bar codes only.
- **Inverse Only** - the digital scanner decodes inverse 1D bar codes only.
- **Inverse Autodetect** - the digital scanner decodes both regular and inverse 1D bar codes.



*Regular
(0)



Inverse Only
(1)



Inverse Autodetect
(2)

Postal Codes

US Postnet

Parameter # 89

To enable or disable US Postnet, scan the appropriate bar code below.



Enable US Postnet
(1)



*Disable US Postnet
(0)

US Planet

Parameter # 90

To enable or disable US Planet, scan the appropriate bar code below.



Enable US Planet
(1)



*Disable US Planet
(0)

Transmit US Postal Check Digit

Parameter # 95

Select whether to transmit US Postal data, which includes both US Postnet and US Planet, with or without the check digit.

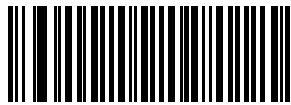

*Transmit US Postal Check Digit
(1)

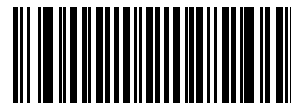

Do Not Transmit US Postal Check Digit
(0)

UK Postal

Parameter # 91

To enable or disable UK Postal, scan the appropriate bar code below.



Enable UK Postal
(1)



*Disable UK Postal
(0)

Transmit UK Postal Check Digit

Parameter # 96

Select whether to transmit UK Postal data with or without the check digit.



***Transmit UK Postal
Check Digit
(1)**



**Do Not Transmit UK Postal Check Digit
(0)**

Japan Postal

Parameter # 290

To enable or disable Japan Postal, scan the appropriate bar code below.



**Enable Japan Postal
(1)**



***Disable Japan Postal
(0)**

Australia Post

Parameter # 291

To enable or disable Australia Post, scan the appropriate bar code below.



**Enable Australia Post
(1)**



***Disable Australia Post
(0)**

Australia Post Format

Parameter # 718

To select one of the following formats for Australia Post, scan the appropriate bar code below:

- **Autodiscriminate** (or Smart mode) - Attempt to decode the Customer Information Field using the N and C Encoding Tables.
- ✓ **NOTE** This option increases the risk of misdecodes because the encoded data format does not specify the Encoding Table used for encoding.
- **Raw Format** - Output raw bar patterns as a series of numbers 0 through 3.
- **Alphanumeric Encoding** - Decode the Customer Information Field using the C Encoding Table.
- **Numeric Encoding** - Decode the Customer Information Field using the N Encoding Table.

For more information on Australia Post Encoding Tables, refer to the *Australia Post Customer Barcoding Technical Specifications* available at <http://www.auspost.com.au>.



*Autodiscriminate
(0)



Raw Format
(1)



Alphanumeric Encoding
(2)



Numeric Encoding
(3)

Netherlands KIX Code

Parameter # 326

To enable or disable Netherlands KIX Code, scan the appropriate bar code below.



Enable Netherlands KIX Code
(1)



*Disable Netherlands KIX Code
(0)

USPS 4CB/One Code/Intelligent Mail

Parameter # 592

To enable or disable USPS 4CB/One Code/Intelligent Mail, scan the appropriate bar code below.



Enable USPS 4CB/One Code/Intelligent Mail
(1)



*Disable USPS 4CB/One Code/Intelligent Mail
(0)

UPU FICS Postal

Parameter # 611

To enable or disable UPU FICS Postal, scan the appropriate bar code below.



**Enable UPU FICS Postal
(1)**

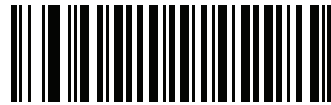

***Disable UPU FICS Postal
(0)**

GS1 DataBar

The variants of GS1 DataBar are DataBar-14, DataBar Expanded, and DataBar Limited. The limited and expanded versions have stacked variants. Scan the appropriate bar codes to enable or disable each variant of GS1 DataBar.

GS1 DataBar-14

Parameter # 338

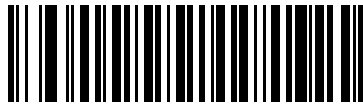

*Enable GS1 DataBar-14
(1)

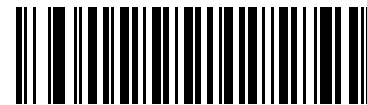

Disable GS1 DataBar-14
(0)

GS1 DataBar Limited

Parameter # 339



Enable GS1 DataBar Limited
(1)

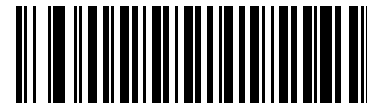

*Disable GS1 DataBar Limited
(0)



NOTE For HC configurations, the default is **Enable**.

GS1 DataBar Expanded

Parameter # 340

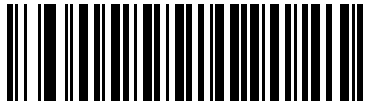

* Enable GS1 DataBar Expanded
(1)



Disable GS1 DataBar Expanded
(0)

GS1 DataBar Limited Security Level

Parameter # 728

The digital scanner offers four levels of decode security for GS1 DataBar Limited bar codes. There is an inverse relationship between security and digital scanner aggressiveness. Increasing the level of security may result in reduced aggressiveness in scanning, so choose only that level of security necessary.

- Level 1 – No clear margin required. This complies with the original GS1 standard, yet might result in erroneous decoding of the DataBar Limited bar code when scanning some UPC symbols that start with digits “9” and “7”
- Level 2 – Automatic risk detection. This level of security may result in erroneous decoding of DataBar Limited bar codes when scanning some UPC symbols. The scanner defaults to Level 3, otherwise to Level 1.
- Level 3 – Security level reflects newly proposed GS1 standard that requires a 5 times trailing clear margin.
- Level 4 – Security level extends beyond the standard required by GS1. This level of security requires a 5 times leading and trailing clear margin.



GS1 DataBar Limited Security Level 1
(1)



GS1 DataBar Limited Security Level 2
(2)



*GS1 DataBar Limited Security Level 3
(3)

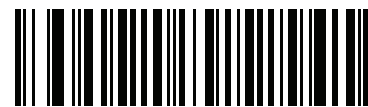

GS1 DataBar Limited Security Level 4
(4)

Convert GS1 DataBar to UPC/EAN

Parameter # 397

This parameter only applies to GS1 DataBar-14 and GS1 DataBar Limited symbols not decoded as part of a Composite symbol. Enable this to strip the leading '010' from DataBar-14 and DataBar Limited symbols encoding a single zero as the first digit, and report the bar code as EAN-13.

For bar codes beginning with two or more zeros but not six zeros, this parameter strips the leading '0100' and reports the bar code as UPC-A. The UPC-A Preamble parameter that transmits the system character and country code applies to converted bar codes. Note that neither the system character nor the check digit can be stripped.

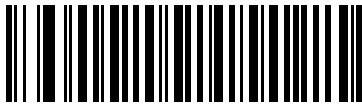

Enable Convert GS1 DataBar to UPC/EAN
(1)

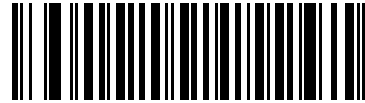

*Disable Convert GS1 DataBar to UPC/EAN
(0)

Composite

Composite CC-C

Parameter # 341

Scan a bar code below to enable or disable Composite bar codes of type CC-C.



Enable CC-C
(1)



*Disable CC-C
(0)



NOTE For HC configurations, the default is **Enable CC-C**.

Composite CC-A/B

Parameter # 342

Scan a bar code below to enable or disable Composite bar codes of type CC-A/B.



Enable CC-A/B
(1)



*Disable CC-A/B
(0)



NOTE For HC configurations, the default is **Enable CC-A/B**.

Composite TLC-39

Parameter # 371

Scan a bar code below to enable or disable Composite bar codes of type TLC-39.

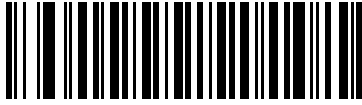

Enable TLC39
(1)

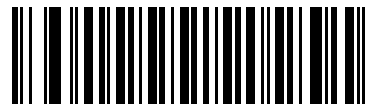

*Disable TLC39
(0)

UPC Composite Mode

Parameter # 344

Select an option for linking UPC symbols with a 2D symbol during transmission as if they were one symbol:

- Select **UPC Never Linked** to transmit UPC bar codes regardless of whether a 2D symbol is detected.
- Select **UPC Always Linked** to transmit UPC bar codes and the 2D portion. If 2D is not present, the UPC bar code does not transmit.
- If you select **Autodiscriminate UPC Composites**, the digital scanner determines if there is a 2D portion, then transmits the UPC, as well as the 2D portion if present.

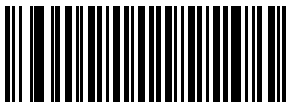

*UPC Never Linked
(0)



UPC Always Linked
(1)

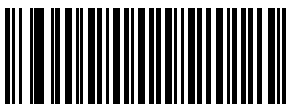

Autodiscriminate UPC Composites
(2)

Composite Beep Mode

Parameter # 398

To select the number of decode beeps when a composite bar code is decoded, scan the appropriate bar code.

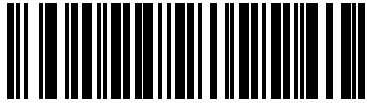

Single Beep After Both are Decoded
(0)



*Beep as Each Code Type is Decoded
(1)

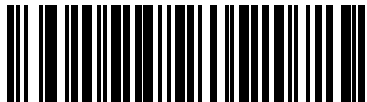

Double Beep after Both are Decoded
(2)



NOTE For HC configurations, the default is **Single Beep After Both are Decoded**.

GS1-128 Emulation Mode for UCC/EAN Composite Codes

Parameter # 427

Select whether to enable or disable this mode.



Enable GS1-128 Emulation Mode for
UCC/EAN Composite Codes
(1)



*Disable GS1-128 Emulation Mode for
UCC/EAN Composite Codes
(0)

2D Symbologies

Enable/Disable PDF417

Parameter # 15

To enable or disable PDF417, scan the appropriate bar code below.



***Enable PDF417
(1)**



**Disable PDF417
(0)**

Enable/Disable MicroPDF417

Parameter # 227

To enable or disable MicroPDF417, scan the appropriate bar code below.



**Enable MicroPDF417
(1)**



***Disable MicroPDF417
(0)**

Code 128 Emulation

Parameter # 123

Enable this parameter to transmit data from certain MicroPDF417 symbols as Code 128. [UPC/EAN/JAN Supplemental AIM ID Format on page 15-14](#) must be enabled for this parameter to work.

Enable Code 128 Emulation to transmit these MicroPDF417 symbols with one of the following prefixes:

-]C1 if the first codeword is 903-905
-]C2 if the first codeword is 908 or 909
-]C0 if the first codeword is 910 or 911

Disable Code 128 Emulation to transmit these MicroPDF417 symbols with one of the following prefixes:

-]L3 if the first codeword is 903-905
-]L4 if the first codeword is 908 or 909
-]L5 if the first codeword is 910 or 911

Scan a bar code below to enable or disable Code 128 Emulation.



NOTE Linked MicroPDF codewords 906, 907, 912, 914, and 915 are not supported. Use GS1 Composites instead.



Enable Code 128 Emulation
(1)



***Disable Code 128 Emulation**
(0)

Data Matrix

Parameter # 292

To enable or disable Data Matrix, scan the appropriate bar code below.



*Enable Data Matrix
(1)



Disable Data Matrix
(0)

Data Matrix Inverse

Parameter # 588

This parameter sets the Data Matrix inverse decoder setting. Options are:

- **Regular Only** - the digital scanner decodes regular Data Matrix bar codes only.
- **Inverse Only** - the digital scanner decodes inverse Data Matrix bar codes only.
- **Inverse Autodetect** - the digital scanner decodes both regular and inverse Data Matrix bar codes.*



*Regular
(0)



Inverse Only
(1)



Inverse Autodetect
(2)



NOTE For HC configurations, the default is **Inverse Autodetect**.

Maxicode

Parameter # 294

To enable or disable Maxicode, scan the appropriate bar code below.



**Enable Maxicode
(1)**



***Disable Maxicode
(0)**

QR Code

Parameter # 293

To enable or disable QR Code, scan the appropriate bar code below.



***Enable QR Code
(1)**



**Disable QR Code
(0)**

QR Inverse

Parameter # 587

This parameter sets the QR inverse decoder setting. Options are:

- **Regular Only** - the digital scanner decodes regular QR bar codes only.
- **Inverse Only** - the digital scanner decodes inverse QR bar codes only.
- **Inverse Autodetect** - the digital scanner decodes both regular and inverse QR bar codes.



*Regular
(0)



Inverse Only
(1)



Inverse Autodetect
(2)

MicroQR

Parameter # 573

To enable or disable MicroQR, scan the appropriate bar code below.



*Enable MicroQR
(1)



Disable MicroQR
(0)

Aztec

Parameter # 574

To enable or disable Aztec, scan the appropriate bar code below.



*Enable Aztec
(1)



Disable Aztec
(0)

Aztec Inverse

Parameter # 589

This parameter sets the Aztec inverse decoder setting. Options are:

- **Regular Only** - the digital scanner decodes regular Aztec bar codes only.
- **Inverse Only** - the digital scanner decodes inverse Aztec bar codes only.
- **Inverse Autodetect** - the digital scanner decodes both regular and inverse Aztec bar codes.



*Regular
(0)



Inverse Only
(1)



Inverse Autodetect
(2)

Redundancy Level

Parameter # 78

The digital scanner offers four levels of decode redundancy. Select higher redundancy levels for decreasing levels of bar code quality. As redundancy levels increase, the digital scanner's aggressiveness decreases.

Select the redundancy level appropriate for the bar code quality.

Redundancy Level 1

The following code types must be successfully read twice before being decoded:

Table 15-2 *Redundancy Level 1 Codes*

Code Type	Code Length
Codabar	8 characters or less
MSI	4 characters or less
D 2 of 5	8 characters or less
I 2 of 5	8 characters or less

Redundancy Level 2

The following code types must be successfully read twice before being decoded:

Table 15-3 *Redundancy Level 2 Codes*

Code Type	Code Length
All	All

Redundancy Level 3

Code types other than the following must be successfully read twice before being decoded. The following codes must be read three times:

Table 15-4 *Redundancy Level 3 Codes*

Code Type	Code Length
MSI	4 characters or less
D 2 of 5	8 characters or less
I 2 of 5	8 characters or less
Codabar	8 characters or less

Redundancy Level 4

The following code types must be successfully read three times before being decoded:

Table 15-5 *Redundancy Level 4 Codes*

Code Type	Code Length
All	All



*Redundancy Level 1
(1)



Redundancy Level 2
(2)

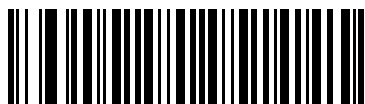

Redundancy Level 3
(3)



Redundancy Level 4
(4)

Security Level

Parameter # 77

The digital scanner offers four levels of decode security for delta bar codes, which include the Code 128 family, UPC/EAN, and Code 93. Select increasing levels of security for decreasing levels of bar code quality. There is an inverse relationship between security and digital scanner aggressiveness, so choose only that level of security necessary for any given application.

- **Security Level 0:** This setting allows the digital scanner to operate in its most aggressive state, while providing sufficient security in decoding most “in-spec” bar codes.
- **Security Level 1:** This default setting eliminates most misdecodes.
- **Security Level 2:** Select this option if Security level 1 fails to eliminate misdecodes.
- **Security Level 3:** If you selected Security Level 2 and misdecodes still occur, select this security level. Be advised, selecting this option is an extreme measure against mis-decoding severely out of spec bar codes. Selecting this level of security significantly impairs the decoding ability of the digital scanner. If you need this level of security, try to improve the quality of the bar codes.

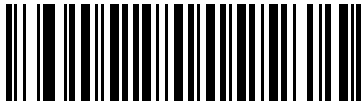

Security Level 0
(0)

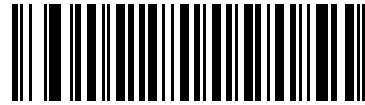

*Security Level 1
(1)



Security Level 2
(2)

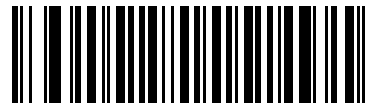

Security Level 3
(3)

Intercharacter Gap Size

Parameter # 381

The Code 39 and Codabar symbologies have an intercharacter gap that is typically quite small. Due to various bar code-printing technologies, this gap can grow larger than the maximum size allowed, preventing the digital scanner from decoding the symbol. If this problem occurs, scan the **Large Intercharacter Gaps** parameter to tolerate these out-of-specification bar codes.



*Normal Intercharacter Gaps
(6)



Large Intercharacter Gaps
(10)

Report Version

Scan the bar code below to report the version of software installed in the digital scanner.



Report Software Version

Macro PDF Features

Macro PDF is a special feature for concatenating multiple PDF symbols into one file. The scanner can decode symbols that are encoded with this feature, and can store more than 64 Kb of decoded data stored in up to 50 MacroPDF symbols.



CAUTION When printing, keep each Macro PDF sequence separate, as each sequence has unique identifiers. Do not mix bar codes from several Macro PDF sequences, even if they encode the same data. When scanning Macro PDF sequences, scan the entire Macro PDF sequence without interruption. If, when scanning a mixed sequence, the digital scanner emits two long low beeps (Low/Low) this indicates an inconsistent file ID or inconsistent symbology error.

Flush Macro Buffer

This flushes the buffer of all decoded Macro PDF data stored to that point, transmits it to the host device, and aborts from Macro PDF mode.



Flush Macro PDF Buffer

Abort Macro PDF Entry

This clears all currently-stored Macro PDF data in the buffer without transmission and aborts from Macro PDF mode.



Abort Macro PDF Entry

CHAPTER 16 ADVANCED DATA FORMATTING

Introduction

Advanced Data Formatting (ADF) is a means of customizing data before transmission to the host device. Use ADF to edit scan data to suit requirements. Implement ADF by scanning a related series of bar codes which program the digital scanner with ADF rules.

For information and programming bar codes for ADF, refer to the *Advanced Data Formatting Programmer Guide*, p/n 72E-69680-xx.

CHAPTER 17 DRIVER'S LICENSE SET UP (DS6878-DL)

Introduction

The DS6878-DL digital scanner is capable of parsing out information from standard US driver's licenses and certain other American Association of Motor Vehicle Administrators (AAMVA) compliant ID cards. This is achieved using internally embedded algorithms, where scanning bar codes activates algorithms internally embedded in the digital scanner to produce formatted data. Use the formatted data for age verification, credit card application information, and more.

This chapter describes how to program the DS6878-DL digital scanner to read and use the data contained in the 2D bar codes on US driver's licenses and AAMVA compliant ID cards.

DL Parsing Parameter Defaults

Table 17-1 lists the defaults for all DL Parsing parameters. To change the default values, scan the appropriate bar codes in this chapter. These new values replace the standard default values in memory. To recall the default parameter values, scan the *Default Parameters on page 5-5*.

✓ **NOTE** See *Appendix A, Standard Default Parameters* for all user preferences, hosts, and miscellaneous default parameters.

Table 17-1 *DL Parsing Default Parameters*

Parameter	Default	Page Number
DL Parsing Parameters		
Driver's License Parsing	No Driver's License Parsing	17-3
Driver's License Parse Field Bar Codes	N/A	17-4
AAMVA Parse Field Bar Codes	N/A	17-7
Set Default Parameter	N/A	17-17
Output Gender as M or F	N/A	17-17
Date Format	CCYYMMDD	17-18
No Separator	N/A	17-19
Send Keystroke	N/A	17-20
Control Characters		17-20
Keyboard Characters		17-24
Parsing Rule Example	N/A	17-39
Embedded Driver's License Parsing ADF Example	N/A	17-43

Driver's License Parsing

To enable driver's license parsing on the digital scanner, scan the **Embedded Driver's License Parsing** bar code.

Scan the bar codes on the following pages in the order indicating the sequence of data fields that the digital scanner outputs. See [Parsing Driver's License Data Fields \(Embedded Driver's License Parsing\) on page 17-3](#) for more information.

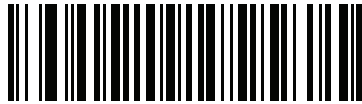

*No Driver's License Parsing



Embedded Driver's License Parsing

Parsing Driver's License Data Fields (Embedded Driver's License Parsing)

To begin programming a parsing rule:

1. Scan [Begin New Driver's License Parse Rule on page 17-4](#).
2. Scan any of the field bar codes on the following pages, or [Send Keystroke \(Control Characters and Keyboard Characters\) on page 17-20](#) to complete the parsing rule.
3. After entering the entire rule, scan [Save Driver's License Parse Rule on page 17-4](#) to save the rule.

✓ **NOTE** Only ONE driver's license parsing rule may be stored in memory at any time. Saving a new rule replaces the prior rule.

To abort the programming sequence at any time during programming, scan [Quit Entering Driver's License Rule on page 17-4](#). Any previously saved rule is retained.

To erase a programmed saved rule, scan [Erase Driver's License Parse Rules on page 17-4](#).

Embedded Driver's License Parsing Criteria - Code Type

After specifying the fields and their order for the parsed driver's license, you can also apply standard ADF rules to the parsed data using the **Parsed Driver's License** criterion bar code in the *Advanced Data Formatting Programmer Guide*.

✓ **NOTE** Only create standard ADF rules on parsed driver's license data when configured for Embedded Driver's License Parsing.

See [Embedded Driver's License Parsing ADF Example on page 17-43](#) for a sample ADF rule using this code type criterion.

Driver's License Parse Field Bar Codes

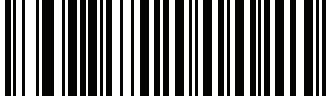

Begin New Driver's License Parse Rule



Save Driver's License Parse Rule



Quit Entering Driver's License Rule



Erase Driver's License Parse Rules

Driver's License Parse Field Bar Codes (continued)

The parse fields currently supported begin below. Not all IDs present data in the same format. For example, some IDs may have separate fields for first name, last name, and middle initial, and others may have a single field with the entire name. In addition, some IDs may expire on the subject's birth date and the actual expiration date field may only indicate the year. In order to present data in a consistent format, the following nine bar codes return data that may be calculated from the actual data contained within the ID bar code.



First Name

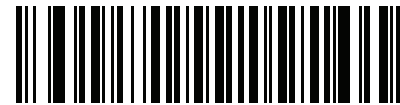

Middle Name/Initial

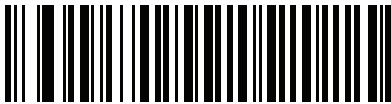

Last Name



Name Suffix

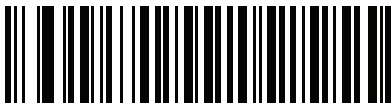

Name Prefix



Expiration Date



Birth Date

Driver's License Parse Field Bar Codes (continued)

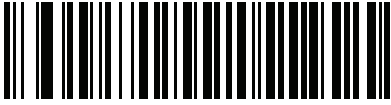

Issue Date



ID Number (Formatted)

AAMVA Parse Field Bar Codes

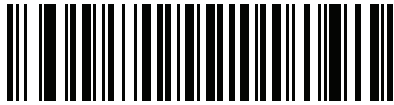

AAMVA Issuer ID



Full Name

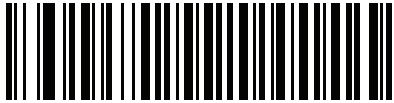

Last Name

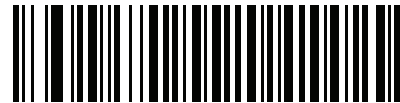

First Name



Middle Name / Initial



Name Suffix



Name Prefix

AAMVA Parse Field Bar Codes (continued)



Mailing Address Line 1

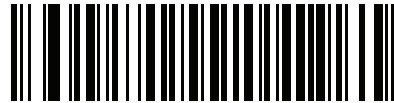

Mailing Address Line 2



Mailing Address City

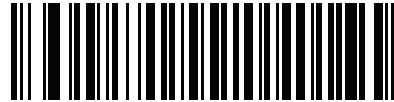

Mailing Address State



Mailing Address Postal Code



Home Address Line 1



Home Address Line 2

AAMVA Parse Field Bar Codes (continued)

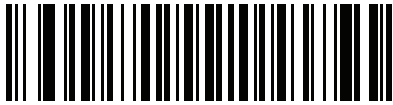

Home Address City

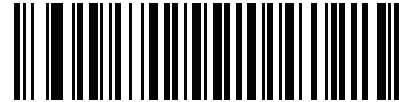

Home Address State

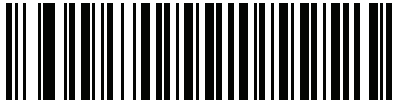

Home Address Postal Code

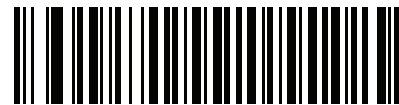

License ID Number

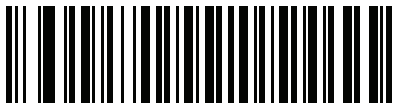

License Class

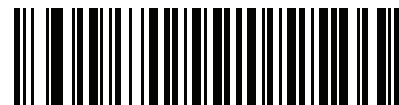

License Restrictions



License Endorsements

AAMVA Parse Field Bar Codes (continued)



Height (Feet and/or Inches)

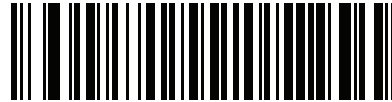

Height (Centimeters)

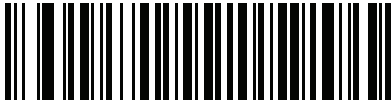

Weight (Pounds)

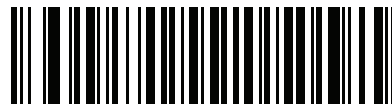

Weight (Kilograms)

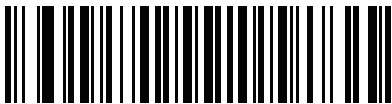

Eye Color



Hair Color



License Expiration Date

AAMVA Parse Field Bar Codes (continued)



Birth Date

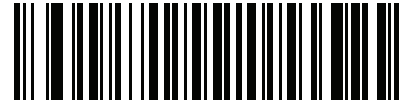

Gender

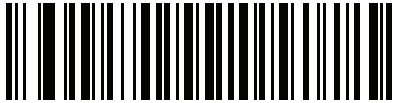

License Issue Date



License Issue State

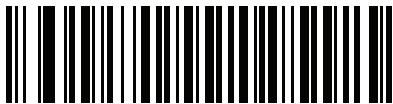

Social Security Number

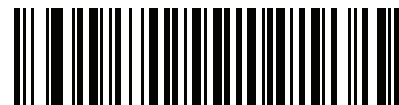

Permit Class

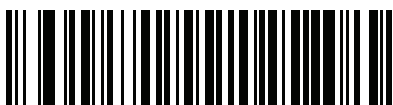

Permit Expiration Date

AAMVA Parse Field Bar Codes (continued)



Permit ID Number

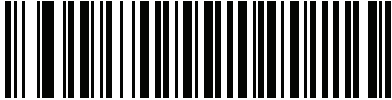

Permit Issue Date



Permit Restrictions



Permit Endorsements



AKA Social Security Name

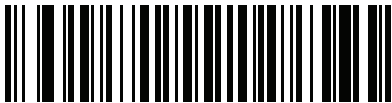

AKA Full Name



AKA Last Name



AKA First Name

AAMVA Parse Field Bar Codes (continued)

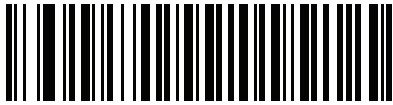

AKA Middle Name / Initial



AKA Name Suffix

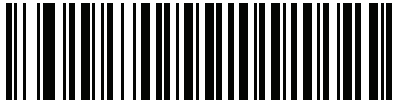

AKA Name Prefix

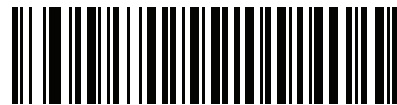

AKA Birth Date



Issue Timestamp



Number of Duplicates

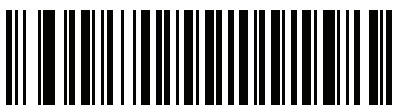

Medical Codes

AAMVA Parse Field Bar Codes (continued)



Organ Donor

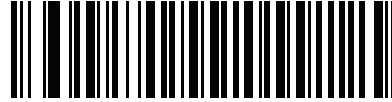

Nonresident



Customer ID

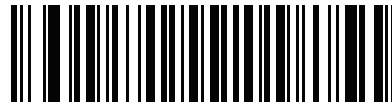

Weight Range

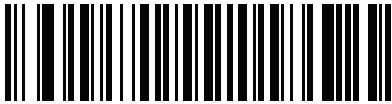

Document Discriminator

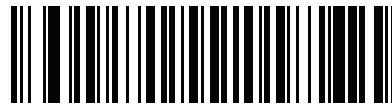

Country



Federal Commission Codes

AAMVA Parse Field Bar Codes (continued)

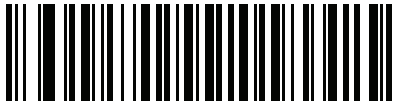

Place of Birth



Audit Information

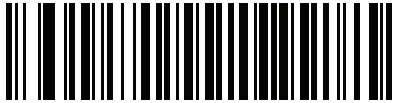

Inventory Control

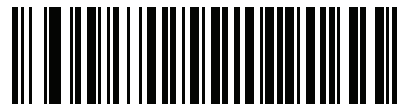

Race / Ethnicity

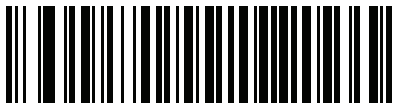

Std Vehicle Class



Std Endorsements



Std Restrictions

AAMVA Parse Field Bar Codes (continued)

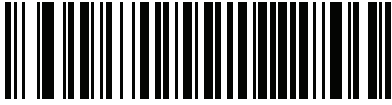

Class Description

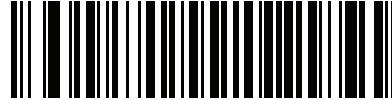

Endorsement Description

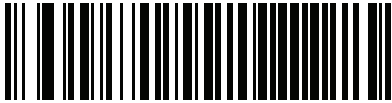

Restrictions Description

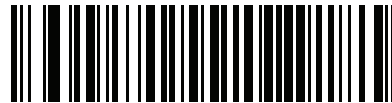

Height in Inches

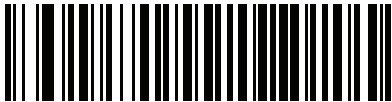

Height in Centimeters

Parser Version ID Bar Codes

Include this field to emit embedded parser software version identification



Parser Version ID

User Preferences

Set Default Parameter

Scan this bar code to return all parameters to the default values listed in [Table A-1 on page A-1](#).



*Set All Defaults

Output Gender as M or F

Scan this bar code to report the gender as **M** or **F** instead of a numeric value.



Output gender as M or F

Date Format

Use these bar codes to select the date format that is displayed. Date fields include the following:

- **CCYY** = 4-digit year (**CC**=2-digit century [00-99], **YY**=2-digit year in the century [00-99])
- **MM** = 2-digit month [01-12]
- **DD** = 2-digit day of the month [00-31]

The default is Date Format **CCYYMMDD**.

- ✓ **NOTE** To specify a date separator, i.e., a character separating each field of the date, scan the **Send <character>** bar code that corresponds to the alphanumeric character to use as the date separator immediately following the date format bar code. To select no date separator, scan the **No Separator** DL parsing rule immediately following the date format bar code.

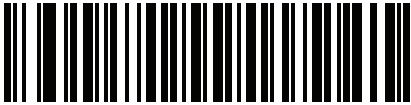

*CCYYMMDD



CCYYDDMM

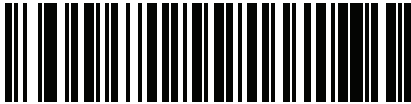

MMDDCCYY

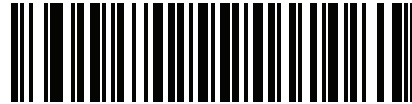

MMCCYYDD

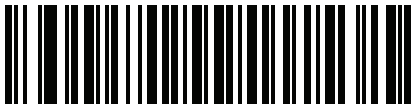

DDMMCCYY



DDCCYYMM

Date Format (continued)

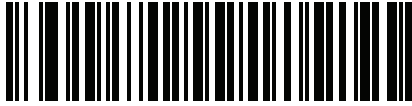

YYMMDD



YYDDMM

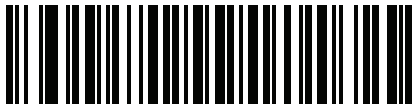

MMDDYY



MMYYDD

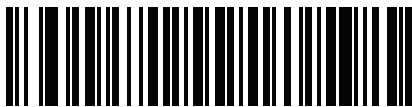

DDMMYY



DDYYMM

No Separator

Scan this bar code immediately following a date format bar code to use no separator character between the date fields.

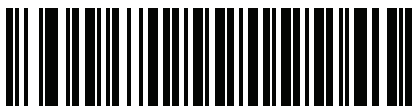

No Separator

Send Keystroke (Control Characters and Keyboard Characters)

Control Characters

Scan a **Send** bar code for the keystroke to send.



Send Control A



Send Control B



Send Control C



Send Control D



Send Control E



Send Control F



Send Control G



Send Control H

Control Characters (continued)



Send Control I



Send Control J



Send Control K



Send Control L



Send Control M



Send Control N



Send Control O



Send Control P

Control Characters (continued)



Send Control Q



Send Control R



Send Control S



Send Control T



Send Control U



Send Control V



Send Control W

Control Characters (continued)



Send Control X



Send Control Y



Send Control Z



Send Control [



**Send Control **



Send Control]

Control Characters (continued)



Send Control 6



Send Control -

Keyboard Characters

Scan a **Send** bar code for the keyboard characters to send.



Send Space



Send !



Keyboard Characters (continued)



Send \$



Send %



Send &



Send '



Send (



Send)



Send *

Keyboard Characters (continued)



Send +



Send ,



Send -



Send .



Send /



Send 0



Send 1

Keyboard Characters (continued)



Send 2



Send 3



Send 4



Send 5



Send 6



Send 7



Send 8

Keyboard Characters (continued)



Send 9



Send :



Send ;



Send <



Send =



Send >



Send ?

Keyboard Characters (continued)



Send @



Send A



Send B



Send C



Send D



Send E



Send F

Keyboard Characters (continued)



Send G



Send H



Send I



Send J



Send K



Send L



Send M

Keyboard Characters (continued)



Send N



Send O



Send P



Send Q



Send R



Send S



Send T

Keyboard Characters (continued)



Send U



Send V



Send W



Send X



Send Y



Send Z

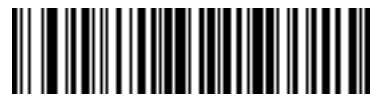

Send [

Keyboard Characters (continued)



Send \



Send]



Send ^



Send _



Send `



Send a



Send b

Keyboard Characters (continued)



Send c



Send d



Send e



Send f



Send g



Send h



Send i

Keyboard Characters (continued)



Send j



Send k



Send l



Send m



Send n



Send o



Send p

Keyboard Characters (continued)



Send q



Send r



Send s



Send t



Send u



Send v



Send w

Keyboard Characters (continued)



Send x



Send y



Send z



Send {



Send |



Send }



Send ~

Keyboard Characters (continued)



Send Tab Key



Send Enter Key

Parsing Rule Example

Scan the following bar codes in sequence to program the digital scanner to extract and transmit first, middle, and last names; mailing address line 1; mailing address line 2; mailing address city; mailing address state; mailing address postal code; and, date of birth. Then, scan a driver's license bar code.

✓ **NOTE** This example applies to RS-232. To use this example with a USB interface, scan [Enable Function Key Mapping on page 7-14](#) in place of the **Send Control M (Carriage Return)** bar codes.

1



Embedded Driver's License Parsing

2



Begin New Driver's License Parse Rule

3



First Name

4



Send Space

5



Middle Name / Initial

6



Send Space

Parsing Rule Example (continued)

7

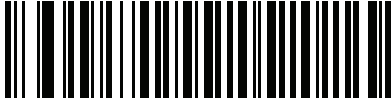

Last Name

8



Send Enter Key

9



Mailing Address Line 1

10



Send Space

11



Mailing Address Line 2

12



Send Enter Key

Parsing Rule Example (continued)

13



Mailing Address City

14



Send Space

15

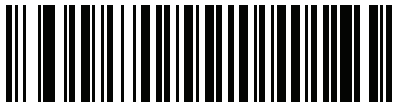

Mailing Address State

16



Send Space

17

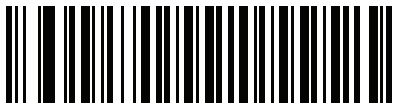

Mailing Address Postal Code

Parsing Rule Example (continued)

18



Send Enter Key

19



Birth Date

20



Send Enter Key

21



Save Driver's Licence Parse Rule

Embedded Driver's License Parsing ADF Example

This example creates a parsing rule for parsed data configured to result in the format:

Last Name, First Name

1

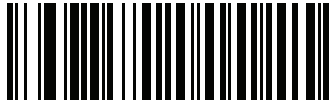

Begin New Driver's License Parse Rule

2



Last Name

3



Send ,

4



Send Space

5



First Name

6



Save Driver's Licence Parse Rule

Then, in order to limit the full name to 15 characters, create the following ADF rule:

1



Begin New Rule

2



Criterion: Parsed Driver's License

3



Action: Send Next 15 Characters

4



Save Rule

For a license belonging to Michael Williams, the parsed data is Williams, Michael and Williams, Micha after applying the previous ADF rule.

APPENDIX A STANDARD DEFAULT PARAMETERS

Table A-1 *Standard Default Parameters*

Parameter	Parameter Number	Default	Page Number
Radio Communications			
Radio Communications (Host Type)	N/A	Cradle Host	4-4
Discoverable Mode	N/A	General	4-7
Wi-Fi Friendly Mode	N/A	Disable	4-8
Wi-Fi Friendly Channel Exclusion	N/A	Use All Channels	4-8
Apple iOS HID Feature	N/A	Disable	4-10
Android HID Feature	N/A	Disable	4-10
Country Keyboard Types (Country Code)	N/A	North American	4-11
HID Keyboard Keystroke Delay	N/A	No Delay (0 msec)	4-13
CAPS Lock Override	N/A	Disable	4-13
Ignore Unknown Characters	N/A	Enable	4-14
Emulate Keypad	N/A	Disable	4-14
Keyboard FN1 Substitution	N/A	Disable	4-15
Function Key Mapping	N/A	Disable	4-15
Simulated Caps Lock	N/A	Disable	4-16
Convert Case	N/A	No Case Conversion	4-16
Beep on Reconnect Attempt	N/A	Disable	4-18
Reconnect Attempt Interval	N/A	30 sec	4-19

¹User selection is required to configure this interface and this is the most common selection.

Table A-1 Standard Default Parameters (Continued)

Parameter	Parameter Number	Default	Page Number
Auto-reconnect in Bluetooth Keyboard Emulation (HID Slave) Mode	N/A	On Bar Code Data	4-20
Modes of Operation (Point-to-Point/Multipoint-to-Point)	N/A	Point-to-Point	4-21
Parameter Broadcast (Cradle Host Only)	N/A	Enable	4-22
Pairing Modes	N/A	Unlocked	4-23
Pairing on Contacts	N/A	Enable	4-24
Connection Maintenance Interval	N/A	15 min	4-27
Authentication	N/A	Disable	4-29
Variable Pin Code	N/A	Static	4-30
Encryption	N/A	Disable	4-31
Secure Simple Pairing IO Capability (SPP Server and SPP Master Host Mode Only)	N/A	No Input/No Output	4-32
User Preferences			
Set Default Parameter	N/A	Set Defaults	5-5
Parameter Bar Code Scanning	236	Enable	5-6
Beep After Good Decode	56	Enable	5-6
Suppress Power Up Beeps	721	Do Not Suppress	5-7
Beeper Tone	145	Medium	5-8
Beeper Volume	140	High	5-9
Beeper Duration	628	Medium	5-10
Beep on Insertion	288	Enabled	5-10
Decode Pager Motor	613	Disable	5-11
Decode Pager Motor Duration	626	150 msec	5-11
Night Mode Trigger	1215	Disable	5-14
Night Mode Toggle	N/A	N/A	5-14
Batch Mode	544	Normal (Do Not Batch Data)	5-15
Hand-held Trigger Mode	138	Level	5-17
Hands-free Mode	630	Enable	5-18
Presentation Performance Mode	650	Standard	5-19

¹User selection is required to configure this interface and this is the most common selection.

Table A-1 Standard Default Parameters (Continued)

Parameter	Parameter Number	Default	Page Number
Low Power Mode	128	Enabled	5-20
Time Delay to Hand-held Low Power Mode	146	100 msec	5-20
Time Delay to Presentation Idle Mode	663	1 Minute	5-23
Time Delay to Presentation Sleep Mode	662	1 Hour	5-26
Timeout to Low Power Mode from Auto Aim	729	15 Sec	5-27
Picklist Mode	402	Disabled Always	5-28
Mobile Phone/Display Mode	716	Disable	5-29
FIPS Security	736	Enabled	5-30
PDF Prioritization	719	Disable	5-31
PDF Prioritization Timeout	720	200 ms	5-31
Continuous Bar Code Read	649	Disable	5-32
Unique Bar Code Reporting	723	Disable	5-32
Decode Session Timeout	136	9.9 Sec	5-33
Timeout Between Decodes, Same Symbol	137	0.5 Sec	5-33
Timeout Between Decodes, Different Symbols	144	0.2 Sec	5-33
Fuzzy 1D Processing	514	Enable	5-34
Hand-held Decode Aiming Pattern	306	Enable	5-34
Hands-free Decode Aiming Pattern	590	Enable	5-35
Presentation Mode Field of View	609	Full	5-36
Decoding Illumination	298	Enable	5-37
Multicode Mode	677	Disable	5-37
Multicode Expression	661	1	5-38
Multicode Mode Concatenation	717	Disable	5-43
Multicode Concatenation Symbology	722	Concatenate as PDF417	5-44
Miscellaneous Options			
Transmit Code ID Character	45	None	5-47
Prefix Value	99,105	7013 <CR><LF>	5-48
Suffix 1 Value Suffix 2 Value	98, 104 100, 106	7013 <CR><LF>	5-48
Scan Data Transmission Format	235	Data as is	5-49

¹User selection is required to configure this interface and this is the most common selection.

Table A-1 Standard Default Parameters (Continued)

Parameter	Parameter Number	Default	Page Number
FN1 Substitution Values	103, 109	Set	5-50
Transmit "No Read" Message	94	Disable	5-51
Unsolicited Heartbeat Interval	1118	Disable	5-52
Dump Scanner Parameters	N/A	N/A	5-53
Report Version			5-53
Imaging Preferences			
Operational Modes	N/A	N/A	6-4
Image Capture Illumination	361	Enable	6-5
Gain / Exposure Priority for Snapshot Mode	562	Autodetect	6-6
Snapshot Mode Timeout	323	0 (30 seconds)	6-7
Snapshot Aiming Pattern	300	Enable	6-7
Image Cropping	301	Disable	6-7
Crop to Pixel Addresses	315 316 317 318	0 top 0 left 479 bottom 751 right	6-8
Image Size (Number of Pixels)	302	Full	6-9
Image Brightness (Target White)	390	180	6-10
JPEG Image Options	299	Quality	6-10
JPEG Target File Size	561	160 kB	6-11
JPEG Quality and Size Value	305	65	6-11
Image Enhancement	564	Off (0)	6-12
Image File Format Selection	304	JPEG	6-13
Image Rotation	665	0	6-14
Bits per Pixel (BPP)	303	8 BPP	6-15
Signature Capture	93	Disable	6-16
Signature Capture Image File Format Selection	313	JPEG	6-17
Signature Capture Bits per Pixel (BPP)	314	8 BPP	6-18
Signature Capture Width	366	400	6-19
Signature Capture Height	367	100	6-19
Signature Capture JPEG Quality	421	65	6-19

¹User selection is required to configure this interface and this is the most common selection.

Table A-1 Standard Default Parameters (Continued)

Parameter	Parameter Number	Default	Page Number
USB Host Parameters			
USB Device Type	N/A	USB Keyboard (HID)	7-5
Symbol Native API (SNAPI) Status Handshaking	N/A	Enable	7-7
USB Country Keyboard Types (Country Codes)	N/A	North American	7-8
USB Keystroke Delay	N/A	No Delay	7-10
USB CAPS Lock Override	N/A	Disable	7-10
USB Ignore Unknown Characters	N/A	Send	7-11
USB Convert Unknown to Code 39	N/A	Disable	7-11
Emulate Keypad	N/A	Disable	7-12
Emulate Keypad with Leading Zero	N/A	Disable	7-12
Quick Keypad Emulation	N/A	Disable	7-13
USB FN1 Substitution	N/A	Disable	7-13
USB Static CDC	N/A	Enable	7-14
Function Key Mapping	N/A	Disable	7-14
Simulated Caps Lock	N/A	Disable	7-15
Convert Case	N/A	No Case Conversion	7-15
Ignore Beep	N/A	Disable	7-16
Ignore Bar Code Configuration	N/A	Disable	7-16
USB Polling Interval	N/A	8 msec	7-17
RS-232 Host Parameters			
RS-232 Host Types	N/A	Standard	8-6
Baud Rate	N/A	9600	8-8
Parity Type	N/A	None	8-9
Data Bits (ASCII Format)	N/A	8-Bit	8-9
Check Receive Errors	N/A	Enable	8-10
Hardware Handshaking	N/A	None	8-10
Software Handshaking	N/A	None	8-12
Host Serial Response Time-out	N/A	2 sec	8-14
RTS Line State	N/A	Low RTS	8-15
Beep on <BEL>	N/A	Disable	8-15

¹User selection is required to configure this interface and this is the most common selection.

Table A-1 Standard Default Parameters (Continued)

Parameter	Parameter Number	Default	Page Number
Intercharacter Delay	N/A	0 msec	8-16
Nixdorf Beep/LED Options	N/A	Normal Operation	8-17
Ignore Unknown Characters	N/A	Send Bar Code	8-17
Keyboard Wedge Host Parameters			
Keyboard Wedge Host Type	N/A	IBM PC/AT& IBM PC Compatibles	9-4
Country Types (Country Codes)	N/A	North American	9-5
Ignore Unknown Characters	N/A	Send	9-7
Keystroke Delay	N/A	No Delay	9-7
Intra-Keystroke Delay	N/A	Disable	9-8
Alternate Numeric Keypad Emulation	N/A	Disable	9-8
Caps Lock On	N/A	Disable	9-9
Caps Lock Override	N/A	Disable	9-9
Convert Wedge Data	N/A	No Convert	9-10
Function Key Mapping	N/A	Disable	9-10
FN1 Substitution	N/A	Disable	9-11
Send and Make Break	N/A	Send	9-11
IBM 468X/469X Host Parameters			
Port Address	N/A	None Selected	10-4
Convert Unknown to Code 39	N/A	Disable	10-5
Ignore Beep	N/A	Disable	10-6
Ignore Bar Code Configuration	N/A	Disable	10-6
Wand Emulation Host Parameters			
Wand Emulation Host Types	N/A	Symbol OmniLink Interface Controller ¹	11-4
Leading Margin	N/A	80 msec	11-4
Polarity	N/A	Bar High/Margin Low	11-5
Ignore Unknown Characters	N/A	Send	11-5
Convert All Bar Codes to Code 39	N/A	Disable	11-6
Convert Code 39 to Full ASCII	N/A	Disable	11-6

¹User selection is required to configure this interface and this is the most common selection.

Table A-1 Standard Default Parameters (Continued)

Parameter	Parameter Number	Default	Page Number
Scanner Emulation			
Beep Style	N/A	Beep on Successful Transmit	12-4
Parameter Pass-Through	N/A	Parameter Process and Pass Through	12-5
Convert Newer Code Types	N/A	Convert Newer Code Types	12-6
Module Width	N/A	20 μ s	12-6
Convert All Bar Codes to Code 39	N/A	Do Not Convert Bar Codes to Code 39	12-7
Code 39 Full ASCII Conversion	N/A	Disable	12-7
Transmission Timeout	N/A	3 sec	12-8
Ignore Unknown Characters	N/A	Ignore Unknown Characters	12-9
Leading Margin	N/A	2 ms	12-9
Check for Decode LED	N/A	Check for Decode LED	12-10
123Scan² Configuration Tool			
123Scan ² Configuration	N/A	None ¹	13-1
OCR Programming Parameters			
OCR-A	680	Disable	14-3
OCR-A Variant	684	Full ASCII	14-3
OCR-B	681	Disable	14-5
OCR-B Variant	685	Full ASCII	14-6
MICR E13B	682	Disable	14-9
US Currency	683	Disable	14-10
OCR Orientation	687	0°	14-10
OCR Lines	691	1	14-12
OCR Minimum Characters	689	3	14-12
OCR Maximum Characters	690	100	14-13
OCR Security Level	554	80	14-13
OCR Subset	686	Selected font variant	14-14

¹User selection is required to configure this interface and this is the most common selection.

Table A-1 Standard Default Parameters (Continued)

Parameter	Parameter Number	Default	Page Number
OCR Quiet Zone	695	50	14-14
OCR Bright Illumination	701	Disable	14-15
OCR Template	547	54R	14-16
OCR Check Digit Modulus	688	1	14-25
OCR Check Digit Multiplier	700	121212121212	14-26
OCR Check Digit Validation	694	None	14-27
Inverse OCR	856	Regular	14-32
UPC/EAN			
UPC-A	1	Enable	15-7
UPC-E	2	Enable	15-7
UPC-E1	12	Disable	15-8
EAN-8/JAN 8	4	Enable	15-8
EAN-13/JAN 13	3	Enable	15-9
Bookland EAN	83	Disable	15-9
Decode UPC/EAN/JAN Supplementals (2 and 5 digits)	16	Ignore	15-10
User-Programmable Supplementals			15-13
Supplemental 1:	579		
Supplemental 2:	580		
UPC/EAN/JAN Supplemental Redundancy	80	10	15-13
Decode UPC/EAN/JAN Supplemental AIM ID	672	Combined	15-14
Transmit UPC-A Check Digit	40	Enable	15-15
Transmit UPC-E Check Digit	41	Enable	15-15
Transmit UPC-E1 Check Digit	42	Enable	15-16
UPC-A Preamble	34	System Character	15-16
UPC-E Preamble	35	System Character	15-17
UPC-E1 Preamble	36	System Character	15-18
Convert UPC-E to A	37	Disable	15-19
Convert UPC-E1 to A	38	Disable	15-19
EAN-8/JAN-8 Extend	39	Disable	15-20
Bookland ISBN Format	576	ISBN-10	15-20

¹User selection is required to configure this interface and this is the most common selection.

Table A-1 Standard Default Parameters (Continued)

Parameter	Parameter Number	Default	Page Number
UCC Coupon Extended Code	85	Disable	15-21
Coupon Report	730	New Coupon Format	15-22
ISSN EAN	617	Disable	15-22
Code 128			
Code 128	8/	Enable	15-23
Set Length(s) for Code 128	209, 210	Any Length	15-25
GS1-128 (formerly UCC/EAN-128)	14	Enable	15-25
ISBT 128	84	Enable	15-25
ISBT Concatenation	577	Disable	15-26
Check ISBT Table	578	Enable	15-27
ISBT Concatenation Redundancy	223	10	15-27
Code 39			
Code 39	0	Enable	15-28
Trioptic Code 39	13	Disable	15-28
Convert Code 39 to Code 32 (Italian Pharmacy Code)	86	Disable	15-29
Code 32 Prefix	231	Disable	15-29
Set Length(s) for Code 39	18, 19	2 to 55	15-30
Code 39 Check Digit Verification	48	Disable	15-31
Transmit Code 39 Check Digit	43	Disable	15-31
Code 39 Full ASCII Conversion	17	Disable	15-32
Buffer Code 39	113	Disable	15-32
Code 93			
Code 93	9	Disable	15-35
Set Length(s) for Code 93	26, 27	4 to 55	15-35
Code 11			
Code 11	10	Disable	15-37
Set Lengths for Code 11	28, 29	4 to 55	15-37
Code 11 Check Digit Verification	52	Disable	15-39
Transmit Code 11 Check Digit(s)	47	Disable	15-40

¹User selection is required to configure this interface and this is the most common selection.

Table A-1 Standard Default Parameters (Continued)

Parameter	Parameter Number	Default	Page Number
Interleaved 2 of 5 (ITF)			
Interleaved 2 of 5 (ITF)	6	Disable	15-41
Set Lengths for I 2 of 5	22, 23	14	15-41
I 2 of 5 Check Digit Verification	49	Disable	15-43
Transmit I 2 of 5 Check Digit	44	Disable	15-43
Convert I 2 of 5 to EAN 13	82	Disable	15-44
Discrete 2 of 5 (DTF)			
Discrete 2 of 5	5	Disable	15-44
Set Length(s) for D 2 of 5	20, 21	12	15-45
Codabar (NW - 7)			
Codabar	7	Disable	15-47
Set Lengths for Codabar	24, 25	5 to 55	15-47
CLSI Editing	54	Disable	15-49
NOTIS Editing	55	Disable	15-49
Codabar Upper or Lower Case Start/Stop Characters Transmission	855	Upper Case	15-50
MSI			
MSI	11	Disable	15-51
Set Length(s) for MSI	30, 31	4 to 55	15-51
MSI Check Digits	50	One	15-53
Transmit MSI Check Digit	46	Disable	15-53
MSI Check Digit Algorithm	51	Mod 10/Mod 10	15-54
Chinese 2 of 5			
Chinese 2 of 5	408	Disable	15-54
Matrix 2 of 5			
Matrix 2 of 5	618	Disable	15-55
Matrix 2 of 5 Lengths	619, 620	1 Length - 14	15-56
Matrix 2 of 5 Check Digit	622	Disable	15-57
Transmit Matrix 2 of 5 Check Digit	623	Disable	15-57

¹User selection is required to configure this interface and this is the most common selection.

Table A-1 Standard Default Parameters (Continued)

Parameter	Parameter Number	Default	Page Number
Korean 3 of 5			
Korean 3 of 5	581	Disable	15-58
Inverse 1D			
Inverse 1D	586	Regular	15-59
Postal Codes			
US Postnet	89	Disable	15-60
US Planet	90	Disable	15-60
Transmit US Postal Check Digit	95	Enable	15-61
UK Postal	91	Disable	15-61
Transmit UK Postal Check Digit	96	Enable	15-62
Japan Postal	290	Disable	15-62
Australian Postal	291	Disable	15-63
Australia Post Format	718	Autodiscriminate	15-64
Netherlands KIX Code	326	Disable	15-65
USPS 4CB/One Code/Intelligent Mail	592	Disable	15-65
UPU FICS Postal	611	Disable	15-66
GS1 DataBar			
GS1 DataBar-14	338	Enable	15-67
GS1 DataBar Limited Non-Healthcare Configurations Healthcare Configurations	339	Disable Enable	15-67
GS1 DataBar Expanded	340	Enable	15-68
GS1 DataBar Limited Security Level	728	Level 3	15-69
Convert GS1 DataBar to UPC/EAN	397	Disable	15-70
Composite			
Composite CC-C Non-Healthcare Configurations Healthcare Configurations	341	Disable Enable	15-71
Composite CC-A/B Non-Healthcare Configurations Healthcare Configurations	342	Disable Enable	15-71
Composite TLC-39	371	Disable	15-72

¹User selection is required to configure this interface and this is the most common selection.

Table A-1 Standard Default Parameters (Continued)

Parameter	Parameter Number	Default	Page Number
UPC Composite Mode	344	Never Linked	15-72
Composite Beep Mode Non-Healthcare Configurations	398	Beep As Each Code Type is Decoded	15-73
Healthcare Configurations		Single Beep After Both are Decoded	
GS1-128 Emulation Mode for UCC/EAN Composite Codes	427	Disable	15-73
2D Symbologies			
PDF417	15	Enable	15-74
MicroPDF417	227	Disable	15-74
Code 128 Emulation	123	Disable	15-75
Data Matrix	292	Enable	15-76
Data Matrix Inverse Non-Healthcare Configurations Healthcare Configurations	588	Regular	15-76
		Inverse Autodetect	
Maxicode	294	Disable	15-77
QR Code	293	Enable	15-77
QR Inverse	587	Regular	15-78
MicroQR	573	Enable	15-78
Aztec	574	Enable	15-79
Aztec Inverse	589	Regular	15-79
Symbology-Specific Security Levels			
Redundancy Level	78	1	15-80
Security Level	77	1	15-82
Intercharacter Gap Size	381	Normal	15-83
Report Version			
Report Software Version	N/A	N/A	15-83
Macro PDF			
Flush Macro PDF Buffer	N/A	N/A	15-84
Abort Macro PDF Entry	N/A	N/A	15-84

¹User selection is required to configure this interface and this is the most common selection.

APPENDIX B PROGRAMMING REFERENCE

Symbol Code Identifiers

Table B-1 *Symbol Code Characters*

Code Character	Code Type
A	UPC-A, UPC-E, UPC-E1, EAN-8, EAN-13
B	Code 39, Code 32
C	Codabar
D	Code 128, ISBT 128, ISBT 128 Concatenated
E	Code 93
F	Interleaved 2 of 5
G	Discrete 2 of 5, or Discrete 2 of 5 IATA
H	Code 11
J	MSI
K	GS1-128
L	Bookland EAN
M	Trioptic Code 39
N	Coupon Code
R	GS1 DataBar Family
S	Matrix 2 of 5
T	UCC Composite, TLC 39
U	Chinese 2 of 5

Table B-1 *Symbol Code Characters (Continued)*

Code Character	Code Type
V	Korean 3 of 5
X	ISSN EAN, PDF417, Macro PDF417, Micro PDF417
z	Aztec, Aztec Rune
P00	Data Matrix
P01	QR Code, MicroQR
P02	Maxicode
P03	US Postnet
P04	US Planet
P05	Japan Postal
P06	UK Postal
P08	Netherlands KIX Code
P09	Australia Post
P0A	USPS 4CB/One Code/Intelligent Mail
P0B	UPU FICS Postal
P0X	Signature Capture

AIM Code Identifiers

Each AIM Code Identifier contains the three-character string **Jcm** where:

- J = Flag Character (ASCII 93)
- c = Code Character (see [Table B-2](#))
- m = Modifier Character (see [Table B-3](#))

Table B-2 *Aim Code Characters*

Code Character	Code Type
A	Code 39, Code 39 Full ASCII, Code 32
C	Code 128, ISBT 128, ISBT 128 Concatenated, GS1-128, Coupon (Code 128 portion)
d	Data Matrix
E	UPC/EAN, Coupon (UPC portion)
e	GS1 DataBar Family
F	Codabar
G	Code 93
H	Code 11
I	Interleaved 2 of 5
L	PDF417, Macro PDF417, Micro PDF417
L2	TLC 39
M	MSI
Q	QR Code, MicroQR
S	Discrete 2 of 5, IATA 2 of 5
U	Maxicode
z	Aztec, Aztec Rune
X	Bookland EAN, ISSN EAN, Trioptic Code 39, Chinese 2 of 5, Matrix 2 of 5, Korean 3 of 5, US Postnet, US Planet, UK Postal, Japan Postal, Australia Post, Netherlands KIX Code, USPS 4CB/One Code/Intelligent Mail, UPU FICS Postal, Signature Capture

The modifier character is the sum of the applicable option values based on [Table B-3](#).

Table B-3 *Modifier Characters*

Code Type	Option Value	Option
Code 39	0	No check character or Full ASCII processing.
	1	Reader has checked one check character.
	3	Reader has checked and stripped check character.
	4	Reader has performed Full ASCII character conversion.
	5	Reader has performed Full ASCII character conversion and checked one check character.
	7	Reader has performed Full ASCII character conversion and checked and stripped check character.
	Example: A Full ASCII bar code with check character W, A+I+MI+DW , is transmitted as J A7 AIMID where 7 = (3+4).	
Trioptic Code 39	0	No option specified at this time. Always transmit 0.
	Example: A Trioptic bar code 412356 is transmitted as J X0 412356	
Code 128	0	Standard data packet, no Function code 1 in first symbol position.
	1	Function code 1 in first symbol character position.
	2	Function code 1 in second symbol character position.
	Example: A Code (EAN) 128 bar code with Function 1 character ^{FNC1} in the first position, AIMID is transmitted as J C1 AIMID	
I 2 of 5	0	No check digit processing.
	1	Reader has validated check digit.
	3	Reader has validated and stripped check digit.
	Example: An I 2 of 5 bar code without check digit, 4123, is transmitted as J I0 4123	
Codabar	0	No check digit processing.
	1	Reader has checked check digit.
	3	Reader has stripped check digit before transmission.
	Example: A Codabar bar code without check digit, 4123, is transmitted as J F0 4123	
Code 93	0	No options specified at this time. Always transmit 0.
	Example: A Code 93 bar code 012345678905 is transmitted as J G00 12345678905	
MSI	0	Check digits are sent.
	1	No check digit is sent.
	Example: An MSI bar code 4123, with a single check digit checked, is transmitted as J M1 4123	

Table B-3 Modifier Characters (Continued)

Code Type	Option Value	Option
D 2 of 5	0	No options specified at this time. Always transmit 0.
	Example: A D 2 of 5 bar code 4123, is transmitted as JS04123	
UPC/EAN	0	Standard data packet in full EAN format, i.e. 13 digits for UPC-A, UPC-E, and EAN-13 (not including supplemental data).
	1	Two digit supplemental data only.
	2	Five digit supplemental data only.
	3	Combined data packet comprising 13 digits from EAN-13, UPC-A or UPC-E symbol and 2 or 5 digits from supplemental symbol.
	4	EAN-8 data packet.
	Example: A UPC-A bar code 012345678905 is transmitted as JE00012345678905	
Bookland EAN	0	No options specified at this time. Always transmit 0.
	Example: A Bookland EAN bar code 123456789X is transmitted as JX0123456789X	
ISSN EAN	0	No options specified at this time. Always transmit 0.
	Example: An ISSN EAN bar code 123456789X is transmitted as JX0123456789X	
Code 11	0	Single check digit
	1	Two check digits
	3	Check characters validated but not transmitted.
GS1 DataBar Family		No option specified at this time. Always transmit 0. GS1 DataBar-14 and GS1 DataBar Limited transmit with an Application Identifier "01". Note: In GS1-128 emulation mode, GS1 DataBar is transmitted using Code 128 rules (i.e., JC1).
	Example: A GS1 DataBar-14 bar code 0110012345678902 is transmitted as Je00110012345678902 .	
EAN.UCC Composites (GS1 DataBar, GS1-128, 2D portion of UPC composite)		Native mode transmission. Note: UPC portion of composite is transmitted using UPC rules.
	0	Standard data packet.
	1	Data packet containing the data following an encoded symbol separator character.
	2	Data packet containing the data following an escape mechanism character. The data packet does not support the ECI protocol.
	3	Data packet containing the data following an escape mechanism character. The data packet supports the ECI protocol.
		GS1-128 emulation Note: UPC portion of composite is transmitted using UPC rules.
	1	Data packet is a GS1-128 symbol (i.e., data is preceded with JC1).

Table B-3 *Modifier Characters (Continued)*

Code Type	Option Value	Option
PDF417, Micro PDF417	0	Reader set to conform to protocol defined in 1994 PDF417 symbology specifications. Note: When this option is transmitted, the receiver cannot reliably determine whether ECIs have been invoked or whether data byte 92 _{DEC} has been doubled in transmission.
	1	Reader set to follow the ECI protocol (Extended Channel Interpretation). All data characters 92 _{DEC} are doubled.
	2	Reader set for Basic Channel operation (no escape character transmission protocol). Data characters 92 _{DEC} are not doubled. Note: When decoders are set to this mode, unbuffered Macro symbols and symbols requiring the decoder to convey ECI escape sequences cannot be transmitted.
	3	The bar code contains a GS1-128 symbol, and the first codeword is 903-907, 912, 914, 915.
	4	The bar code contains a GS1-128 symbol, and the first codeword is in the range 908-909.
	5	The bar code contains a GS1-128 symbol, and the first codeword is in the range 910-911.
	Example: A PDF417 bar code ABCD, with no transmission protocol enabled, is transmitted as]L2ABCD.	
Data Matrix	0	ECC 000-140, not supported.
	1	ECC 200.
	2	ECC 200, FNC1 in first or fifth position.
	3	ECC 200, FNC1 in second or sixth position.
	4	ECC 200, ECI protocol implemented.
	5	ECC 200, FNC1 in first or fifth position, ECI protocol implemented.
	6	ECC 200, FNC1 in second or sixth position, ECI protocol implemented.
MaxiCode	0	Symbol in Mode 4 or 5.
	1	Symbol in Mode 2 or 3.
	2	Symbol in Mode 4 or 5, ECI protocol implemented.
	3	Symbol in Mode 2 or 3, ECI protocol implemented in secondary message.

Table B-3 *Modifier Characters (Continued)*

Code Type	Option Value	Option
QR Code	0	Model 1 symbol.
	1	Model 2 / MicroQR symbol, ECI protocol not implemented.
	2	Model 2 symbol, ECI protocol implemented.
	3	Model 2 symbol, ECI protocol not implemented, FNC1 implied in first position.
	4	Model 2 symbol, ECI protocol implemented, FNC1 implied in first position.
	5	Model 2 symbol, ECI protocol not implemented, FNC1 implied in second position.
	6	Model 2 symbol, ECI protocol implemented, FNC1 implied in second position.
Aztec	0	Aztec symbol.
	C	Aztec Rune symbol.

APPENDIX C SAMPLE BAR CODES

Code 39



UPC/EAN

UPC-A, 100%



EAN-13, 100%



Code 128



Interleaved 2 of 5



GS1 DataBar

✓ **NOTE** GS1 DataBar variants must be enabled to read the bar codes below (see [GS1 DataBar on page 15-67](#)).



10293847560192837465019283746029478450366523
(GS1 DataBar Expanded Stacked)



1234890hjio990mnb
(GS1 DataBar Expanded)



08672345650916
(GS1 DataBar Limited)

GS1 DataBar-14



55432198673467
(GS1 DataBar-14 Truncated)



90876523412674
(GS1 DataBar-14 Stacked)



78123465709811
(GS1 DataBar-14 Stacked Omni-Directional)

PDF417



Data Matrix



Maxicode

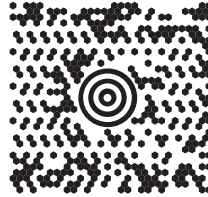

QR Code



US Postnet



UK Postal



APPENDIX D NUMERIC BAR CODES

Numeric Bar Codes

For parameters requiring specific numeric values, scan the appropriately numbered bar code(s).



0



1

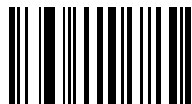

2



3



4

Numeric Bar Codes (continued)



Cancel

To correct an error or change a selection, scan the bar code below.



APPENDIX E ALPHANUMERIC BAR CODES

Alphanumeric Keyboard

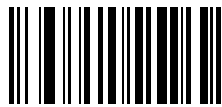

Space

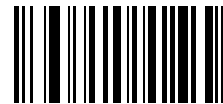

#



\$



%

Alphanumeric Keyboard (continued)



*

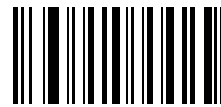

+

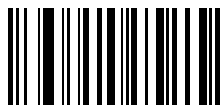

-

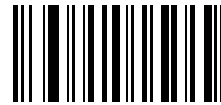

.

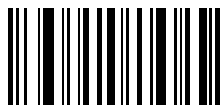

/

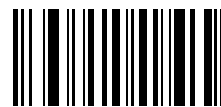

!

Alphanumeric Keyboard (continued)

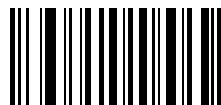

"

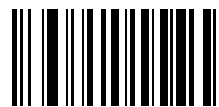

&



'



(



)



:

Alphanumeric Keyboard (continued)



;

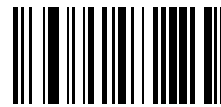

<



=

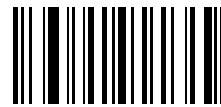

>



?

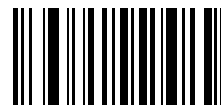

@

Alphanumeric Keyboard (continued)



[



\



]

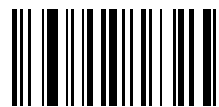

^

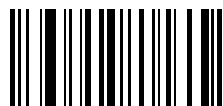

-

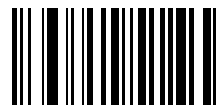

~

Alphanumeric Keyboard (continued)

✓ **NOTE** The bar codes that follow should not be confused with those on the numeric keypad.

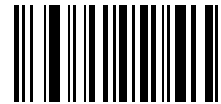

0



1

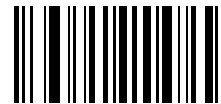

2



3



4



5

Alphanumeric Keyboard (continued)

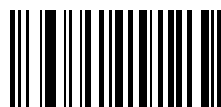

6



7



8



9



End of Message



Cancel

Alphanumeric Keyboard (continued)



A

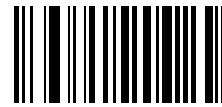

B



C

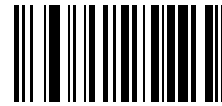

D



E

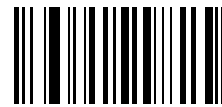

F

Alphanumeric Keyboard (continued)

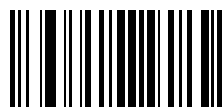

G



H



I



J



K



L

Alphanumeric Keyboard (continued)



M

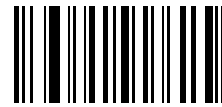

N



O

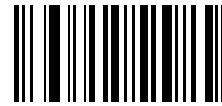

P



Q



R

Alphanumeric Keyboard (continued)



S



T

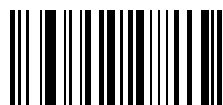

U



V



W



X

Alphanumeric Keyboard (continued)



Y



Z

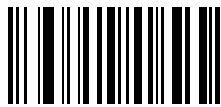

a

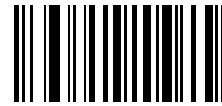

b



c

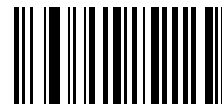

d

Alphanumeric Keyboard (continued)

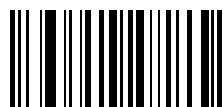

e



f



g



h



i



j

Alphanumeric Keyboard (continued)



k

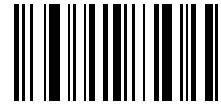

l



m

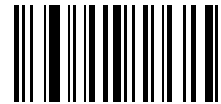

n

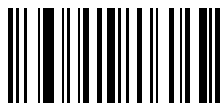

o



p

Alphanumeric Keyboard (continued)

q



r

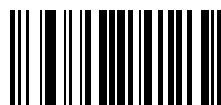

s

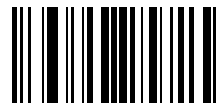

t



u



v

Alphanumeric Keyboard (continued)



w

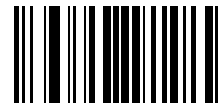

x

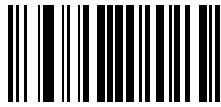

y

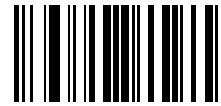

z



{

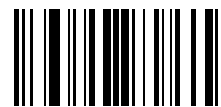

|

Alphanumeric Keyboard (continued)



}



~

APPENDIX F ASCII CHARACTER SETS

Table F-1 *ASCII Value Standard Default Parameters Table*

ASCII Value	Full ASCII Code 39 Encode Character	Keystroke
1000	%U	CTRL 2
1001	\$A	CTRL A
1002	\$B	CTRL B
1003	\$C	CTRL C
1004	\$D	CTRL D
1005	\$E	CTRL E
1006	\$F	CTRL F
1007	\$G	CTRL G
1008	\$H	CTRL H/ BACKSPACE ¹
1009	\$I	CTRL I/ HORIZONTAL TAB ¹
1010	\$J	CTRL J
1011	\$K	CTRL K
1012	\$L	CTRL L
1013	\$M	CTRL M/ ENTER ¹
1014	\$N	CTRL N
1015	\$O	CTRL O

The keystroke in bold is sent only if the “Function Key Mapping” is enabled. Otherwise, the unbolded keystroke is sent.

Table F-1 ASCII Value Standard Default Parameters Table (Continued)

ASCII Value	Full ASCII Code 39 Encode Character	Keystroke
1016	\$P	CTRL P
1017	\$Q	CTRL Q
1018	\$R	CTRL R
1019	\$S	CTRL S
1020	\$T	CTRL T
1021	\$U	CTRL U
1022	\$V	CTRL V
1023	\$W	CTRL W
1024	\$X	CTRL X
1025	\$Y	CTRL Y
1026	\$Z	CTRL Z
1027	%A	CTRL [
1028	%B	CTRL \
1029	%C	CTRL]
1030	%D	CTRL 6
1031	%E	CTRL -
1032	Space	Space
1033	/A	!
1034	/B	"
1035	/C	#
1036	/D	?
1037	/E	%
1038	/F	&
1039	/G	'
1040	/H	(
1041	/I)
1042	/J	*
1043	/K	+
1044	/L	,

The keystroke in bold is sent only if the "Function Key Mapping" is enabled. Otherwise, the unbolded keystroke is sent.

Table F-1 ASCII Value Standard Default Parameters Table (Continued)

ASCII Value	Full ASCII Code 39 Encode Character	Keystroke
1045	-	-
1046	.	.
1047	/o	/
1048	0	0
1049	1	1
1050	2	2
1051	3	3
1052	4	4
1053	5	5
1054	6	6
1055	7	7
1056	8	8
1057	9	9
1058	/Z	:
1059	%F	;
1060	%G	<
1061	%H	=
1062	%I	>
1063	%J	?
1064	%V	@
1065	A	A
1066	B	B
1067	C	C
1068	D	D
1069	E	E
1070	F	F
1071	G	G
1072	H	H
1073	I	I

The keystroke in bold is sent only if the "Function Key Mapping" is enabled. Otherwise, the unbolded keystroke is sent.

Table F-1 ASCII Value Standard Default Parameters Table (Continued)

ASCII Value	Full ASCII Code 39 Encode Character	Keystroke
1074	J	J
1075	K	K
1076	L	L
1077	M	M
1078	N	N
1079	O	O
1080	P	P
1081	Q	Q
1082	R	R
1083	S	S
1084	T	T
1085	U	U
1086	V	V
1087	W	W
1088	X	X
1089	Y	Y
1090	Z	Z
1091	%K	[
1092	%L	\
1093	%M]
1094	%N	^
1095	%O	_
1096	%W	'
1097	+A	a
1098	+B	b
1099	+C	c
1100	+D	d
1101	+E	e
1102	+F	f

The keystroke in bold is sent only if the "Function Key Mapping" is enabled. Otherwise, the unbolded keystroke is sent.

Table F-1 ASCII Value Standard Default Parameters Table (Continued)

ASCII Value	Full ASCII Code 39 Encode Character	Keystroke
1103	+G	g
1104	+H	h
1105	+I	i
1106	+J	j
1107	+K	k
1108	+L	l
1109	+M	m
1110	+N	n
1111	+O	o
1112	+P	p
1113	+Q	q
1114	+R	r
1115	+S	s
1116	+T	t
1117	+U	u
1118	+V	v
1119	+W	w
1120	+X	x
1121	+Y	y
1122	+Z	z
1123	%P	{
1124	%Q	
1125	%R	}
1126	%S	~

The keystroke in bold is sent only if the "Function Key Mapping" is enabled. Otherwise, the unbolded keystroke is sent.

Table F-2 *ALT Key Standard Default Tables*

ALT Keys	Keystroke
2064	ALT 2
2065	ALT A
2066	ALT B
2067	ALT C
2068	ALT D
2069	ALT E
2070	ALT F
2071	ALT G
2072	ALT H
2073	ALT I
2074	ALT J
2075	ALT K
2076	ALT L
2077	ALT M
2078	ALT N
2079	ALT O
2080	ALT P
2081	ALT Q
2082	ALT R
2083	ALT S
2084	ALT T
2085	ALT U
2086	ALT V
2087	ALT W
2088	ALT X
2089	ALT Y
2090	ALT Z

Table F-3 *Misc. Key Standard Default Table*

Misc. Key	Keystroke
3001	PA 1
3002	PA 2
3003	CMD 1
3004	CMD 2
3005	CMD 3
3006	CMD 4
3007	CMD 5
3008	CMD 6
3009	CMD 7
3010	CMD 8
3011	CMD 9
3012	CMD 10
3013	CMD 11
3014	CMD 12
3015	CMD 13
3016	CMD 14

Table F-4 *GUI Shift Keys*

Other Value	Keystroke
3048	GUI 0
3049	GUI 1
3050	GUI 2
3051	GUI 3
3052	GUI 4
3053	GUI 5
3054	GUI 6
3055	GUI 7
3056	GUI 8
3057	GUI 9

The Apple™ iMac keyboard has an apple key on either side of the space bar. Windows-based systems have a GUI key to the left of the left ALT key, and to the right of the right ALT key.

Table F-4 GUI Shift Keys (Continued)

Other Value	Keystroke
3065	GUI A
3066	GUI B
3067	GUI C
3068	GUI D
3069	GUI E
3070	GUI F
3071	GUI G
3072	GUI H
3073	GUI I
3074	GUI J
3075	GUI K
3076	GUI L
3077	GUI M
3078	GUI N
3079	GUI O
3080	GUI P
3081	GUI Q
3082	GUI R
3083	GUI S
3084	GUI T
3085	GUI U
3086	GUI V
3087	GUI W
3088	GUI X
3089	GUI Y
3090	GUI Z

The Apple™ iMac keyboard has an apple key on either side of the space bar. Windows-based systems have a GUI key to the left of the left ALT key, and to the right of the right ALT key.

Table F-5 *PF Key Standard Default Table*

PF Keys	Keystroke
4001	PF 1
4002	PF 2
4003	PF 3
4004	PF 4
4005	PF 5
4006	PF 6
4007	PF 7
4008	PF 8
4009	PF 9
4010	PF 10
4011	PF 11
4012	PF 12
4013	PF 13
4014	PF 14
4015	PF 15
4016	PF 16

Table F-6 *F key Standard Default Table*

F Keys	Keystroke
5001	F 1
5002	F 2
5003	F 3
5004	F 4
5005	F 5
5006	F 6
5007	F 7
5008	F 8
5009	F 9
5010	F 10
5011	F 11

Table F-6 *F key Standard Default Table (Continued)*

F Keys	Keystroke
5012	F 12
5013	F 13
5014	F 14
5015	F 15
5016	F 16
5017	F 17
5018	F 18
5019	F 19
5020	F 20
5021	F 21
5022	F 22
5023	F 23
5024	F 24

Table F-7 *Numeric Key Standard Default Table*

Numeric Keypad	Keystroke
6042	*
6043	+
6044	Undefined
6045	-
6046	.
6047	/
6048	0
6049	1
6050	2
6051	3
6052	4
6053	5
6054	6
6055	7
6056	8

Table F-7 *Numeric Key Standard Default Table (Continued)*

Numeric Keypad	Keystroke
6057	9
6058	Enter
6059	Num Lock

Table F-8 *Extended Keypad Standard Default Table*

Extended Keypad	Keystroke
7001	Break
7002	Delete
7003	Pg Up
7004	End
7005	Pg Dn
7006	Pause
7007	Scroll Lock
7008	Backspace
7009	Tab
7010	Print Screen
7011	Insert
7012	Home
7013	Enter
7014	Escape
7015	Up Arrow
7016	Dn Arrow
7017	Left Arrow
7018	Right Arrow

APPENDIX G COMMUNICATION PROTOCOL FUNCTIONALITY

Functionality Supported via Communication (Cable) Interface

Table G-1 lists supported scanner functionality by communication protocol.

DS6878 with CR0078-S (Standard Cradle)

Table G-1 DS6878 with CR0078-S Communication Interface Functionality

Communication Interfaces	Functionality		
	Data Transmission	Remote Management	Image and Video Transmission
USB			
HID Keyboard Emulation	Supported	Not Available	Not Available
Simple COM Port Emulation	Supported	Not Available	Not Available
CDC COM Port Emulation	Supported	Not Available	Not Available
SSI over CDC COM Port Emulation	Not Available	Not Available	Not Available
IBM Table-Top USB	Supported	Supported	Not Available
IBM Hand-Held USB	Supported	Supported	Not Available
USB OPOS Hand-Held	Supported	Supported	Not Available
Symbol Native API (SNAPI) without Imaging Interface	Not Available	Not Available	Not Available
Symbol Native API (SNAPI) with Imaging Interface	Not Available	Not Available	Not Available
Toshiba TEC	Not Available	Not Available	Not Available

Table G-1 DS6878 with CR0078-S Communication Interface Functionality (Continued)

Communication Interfaces	Functionality		
	Data Transmission	Remote Management	Image and Video Transmission
RS-232			
Standard RS-232	Supported	Not Available	Not Available
ICL RS-232	Supported	Not Available	Not Available
Fujitsu RS-232	Supported	Not Available	Not Available
Wincor-Nixdorf RS-232 Mode A	Supported	Not Available	Not Available
Wincor-Nixdorf RS-232 Mode B	Supported	Not Available	Not Available
Olivetti ORS4500	Supported	Not Available	Not Available
Omron	Supported	Not Available	Not Available
CUTE	Not Available	Not Available	Not Available
OPOS/JPOS	Supported	Not Available	Not Available
SSI	Not Available	Not Available	Not Available
IBM 4690			
Hand-Held Scanner Emulation (Port 9B)	Supported	Not Available	Not Available
Table-Top Scanner Emulation (Port 17)	Supported	Not Available	Not Available
Non-IBM Scanner Emulation (Port 5B)	Supported	Supported	Not Available
Keyboard Wedge			
IBM PC/AT & IBM PC Compatibles	Supported	Not Available	Not Available
IBM AT Notebook	Supported	Not Available	Not Available

DS6878 with CR0078-P (Presentation Cradle)**Table G-2** DS6878 with CR0078-P Communication Interface Functionality

Communication Interfaces	Functionality		
	Data Transmission	Remote Management	Image and Video Transmission
USB			
HID Keyboard Emulation	Supported	Not Available	Not Available
Simple COM Port Emulation	Supported	Not Available	Not Available
CDC COM Port Emulation	Supported	Not Available	Not Available
SSI over CDC COM Port Emulation	Supported	Supported	Not Available
IBM Table-Top USB	Supported	Supported	Not Available
IBM Hand-Held USB	Supported	Supported	Not Available
USB OPOS Hand-Held	Supported	Supported	Not Available
Symbol Native API (SNAPI) without Imaging Interface	Supported	Supported	Not Available
Symbol Native API (SNAPI) with Imaging Interface	Supported	Supported	Supported
Toshiba TEC	Not Available	Not Available	Not Available
RS-232			
Standard RS-232	Supported	Not Available	Not Available
ICL RS-232	Supported	Not Available	Not Available
Fujitsu RS-232	Supported	Not Available	Not Available
Wincor-Nixdorf RS-232 Mode A	Supported	Not Available	Not Available
Wincor-Nixdorf RS-232 Mode B	Supported	Not Available	Not Available
Olivetti ORS4500	Supported	Not Available	Not Available
Omron	Supported	Not Available	Not Available
CUTE	Supported	Not Available	Not Available
OPOS/JPOS	Supported	Not Available	Not Available
SSI	Not Available	Not Available	Not Available
IBM 4690			
Hand-Held Scanner Emulation (Port 9B)	Supported	Not Available	Not Available
Table-Top Scanner Emulation (Port 17)	Supported	Not Available	Not Available
Non-IBM Scanner Emulation (Port 5B)	Supported	Not Available	Not Available

Table G-2 DS6878 with CR0078-P Communication Interface Functionality (Continued)

Communication Interfaces	Functionality		
	Data Transmission	Remote Management	Image and Video Transmission
Keyboard Wedge			
IBM PC/AT & IBM PC Compatibles	Supported	Not Available	Not Available
IBM AT Notebook	Supported	Not Available	Not Available

APPENDIX H SIGNATURE CAPTURE CODE

Introduction

CapCode, a signature capture code, is a special pattern that encloses a signature area on a document and allows a scanner to capture a signature.

There are several accepted patterns that allow automatic identification of different signatures on the same form. For example, on the federal tax return 1040 form there are three signature areas, one each for two joint filers, and one for a professional preparer. By using different patterns, a program can correctly identify all three, so they can be captured in any sequence and still be identified correctly.

Code Structure

Signature Capture Area

A CapCode is printed as two identical patterns on either side of a signature capture box, as shown in [Figure H-1](#). Each pattern extends the full height of the signature capture box.

The box is optional, so you can omit it, replace it with a single baseline, or print a baseline with an "X" on top of it towards the left, as is customarily done in the US to indicate a request for signature. However, if an "X" or other markings are added in the signature box area, these are captured with the signature.



Figure H-1 CapCode

CapCode Pattern Structure

A CapCode pattern structure consists of a start pattern followed by a separator space, a signature capture box, a second separator space, and then a stop pattern. Assuming that X is the dimension of the thinnest element, the start and stop patterns each contains 9X total width in 4 bars and 3 spaces. A 7X quiet zone is required to the left and to the right of the CapCode pattern.

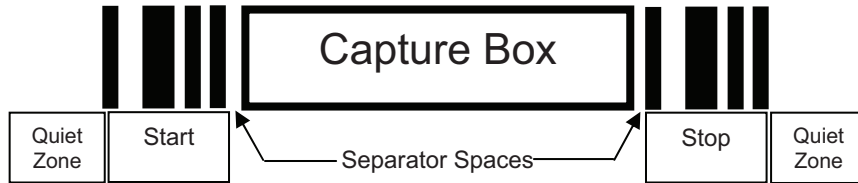

Figure H-2 CapCode Structure

The separator spaces on either side of the signature capture box can be between 1X and 3X wide.

Start / Stop Patterns

Table H-1 lists the accepted start / stop patterns. The bar and space widths are expressed as multiples of X. You must use the same pattern on either side of a signature capture box. The type value is reported with the captured signature to indicate the purpose of the signature captured.

Table H-1 Start / Stop Pattern Definitions

Bar/Space Patterns							Type
B	S	B	S	B	S	B	
1	1	2	2	1	1	1	2
1	2	2	1	1	1	1	5
2	1	1	2	1	1	1	7
2	2	1	1	1	1	1	8
3	1	1	1	1	1	1	9

[Table H-2](#) lists selectable parameters used to generate the image of the captured signature.

Table H-2 *User Defined CapCode Parameters*

Parameter	Defined
Width	Number of pixels
Height	Number of pixels
Format	JPEG, BMP, TIFF
JPEG quality	1 (most compression) to 100 (best quality)
Bits Per Pixel (not applicable to JPEG format)	1 (2 levels)
	4 (16 levels)
	8 (256 levels)

BMP format does not use compression, JPEG and TIFF formats do.

Dimensions

The size of the signature capture box is determined by the height and separation of the start and stop patterns. The line width of the signature capture box is insignificant.

The thinnest element width, referred to here as X, is nominally 10 mils (1 mil = 0.0254 mm). Select this as an exact multiple of the pixel pitch of the printer used. For example, when using a 203 DPI (dots-per-inch) printer and printing 2 dots per module, the resulting X dimension is 9.85 mils.

Data Format

The scanner output is formatted according to [Table H-3](#). Zebra scanners allow different user options to output or inhibit bar code type. Selecting "Symbol ID" as the bar code type for output identifies the CapCode with letter "i".

Table H-3 *Data Format*

File Format (1 byte)	Type (1 byte)	Image Size (4 bytes, BIG Endian)	Image Data
JPEG - 1 BMP - 3 TIFF - 4	See Table H-1 , last column		(Same bytes as in a data file)

Additional Capabilities

Regardless of how the signature is captured, the output signature image is de-skewed and right-side up.

A scanner that captures signatures automatically determines whether it is scanning a signature or a bar code. You can disable the signature capturing capability in a scanner.

Signature Boxes

Figure H-3 illustrates the five acceptable signature boxes:

Type 2:



Type 5:

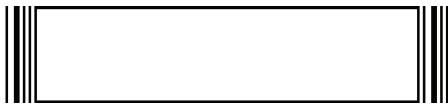

Type 7:



Type 8:

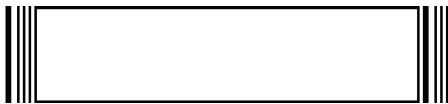

Type 9:



Figure H-3 *Acceptable Signature Boxes*

APPENDIX I NON-PARAMETER ATTRIBUTES

Introduction

This appendix defines non-parameter attributes.

Attributes

Model Number

Attribute #533

Model number of the scanner. This electronic output matches the printout on the physical device label, for example **DS6878-HC2000BWR**.

Type	S
Size (Bytes)	18
User Mode Access	R
Values	Variable

Serial Number

Attribute #534

Unique serial number assigned in the manufacturing facility. This electronic output matches the printout on the physical device label, for example **M1J26F45V**.

Type	S
Size (Bytes)	16
User Mode Access	R
Values	Variable

Date of Manufacture

Attribute #535

Date of device manufacture assigned in the manufacturing facility. This electronic output matches the printout on the physical device label, for example **30APR14** (which reads the 30th of April 2014).

Type	S
Size (Bytes)	7
User Mode Access	R
Values	Variable

Date of First Programming

Attribute #614

Date of first electronic programming represents the first time settings were electronically loaded to the scanner either by 123Scan or via SMS, for example **18MAY14** (which reads the 18th of May 2014).

Type	S
Size (Bytes)	7
User Mode Access	R
Values	Variable

Configuration Filename

Attribute #616

The name assigned to the configuration settings loaded electronically to the device either by 123Scan or via SMS.



NOTE Scanning the **Set Defaults** bar code automatically changes the configuration filename to *factory defaults*.

To indicate the configuration settings loaded to the device were changed, the configuration filename changes to *Modified* upon scanning any parameter bar code.

Type	S
Size (Bytes)	17
User Mode Access	RW
Values	Variable

Night Mode

Attribute #5014

Indicates if the scanner is currently in night mode.

Type	F
Size (Bytes)	1
User Mode Access	R
Values	0 = Day Mode 1 = Night Mode

Pager Motor On Scanner

Attribute #5015

Indicates if a pager motor is present in the scanner .

Type	F
Size (Bytes)	1
User Mode Access	R
Values	0 = No pager motor present in scanner 1 = Pager motor present in scanner

Beeper/LED

Attribute #6000

Activates the beeper and/or LED.

Type	X
Size (Bytes)	N/A
User Mode Access	W

Values:

Beep / LED Action	Value
1 high short beep	0
2 high short beeps	1
3 high short beeps	2
4 high short beeps	3
5 high short beeps	4
1 low short beep	5
2 low short beeps	6
3 low short beeps	7
4 low short beeps	8
5 low short beeps	9
1 high long beep	10
2 high long beeps	11
3 high long beeps	12
4 high long beeps	13
5 high long beeps	14
1 low long beep	15
2 low long beeps	16
3 low long beeps	17
4 low long beeps	18
5 low long beeps	19
Fast warble beep	20
Slow warble beep	21
High-low beep	22
Low-high beep	23
High-low-high beep	24

Low-high-low beep	25
High-high-low-low beep	26
Green LED off	42
Green LED on	43
Red LED on	47
Red LED off	48

Parameter Defaults

Attribute #6001

This attribute restores all parameters to their factory defaults.

Type	X
Size (Bytes)	N/A
User Mode Access	W
Values	0 = Restore Defaults 1 = Restore Factory Defaults 2 = Write Custom Defaults

Beep on Next Bootup

Attribute #6003

This attribute configures (enables or disables) beep on next boot up of scanner.

Type	X
Size (Bytes)	N/A
User Mode Access	W
Values	0 = Disable beep on next bootup 1 = Enable beep on next bootup

Reboot

Attribute #6004

This attribute initiates a device reboot.

Type	X
Size (Bytes)	N/A
User Mode Access	W
Values	N/A

Host Trigger Session

Attribute #6005

This attribute triggers a decode session similar to manually depressing the scanner trigger button.

Type	X
Size (Bytes)	N/A
User Mode Access	W
Values	1 = Start Host Trigger Session 0 = Stop Host Trigger Session

Firmware Version

Attribute #20004

The scanner's operating system version. For example, **NBRFMAAC** or **PAAAABS00-007-R03D0**.

Type	S
Size (Bytes)	Variable
User Mode Access	R
Values	Variable

Scankit Version

Attribute #20008

Identifies the 1D decode algorithms resident on the device, for example **SKIT4.33T02**.

Type	S
Size (Bytes)	Variable
User Mode Access	R
Values	Variable

Imagekit Version

Attribute #20013

Identifies the 2D decode algorithms resident in the device, for example **IMGKIT_4.04T02**.

Type	S
Size (Bytes)	Variable
User Mode Access	R
Values	Variable

In Cradle Detection

Attribute #25000

Indicates if cordless scanner is inserted in the cradle.

Type	B
Size (Bytes)	1
User Mode Access	R
Values	0 = Out of cradle 1 = In cradle

Operational Mode

Attribute #25001

Indicates if the scanner is being used in hand-held or hands-free mode.

Type	B
Size (Bytes)	1
User Mode Access	R
Values	0 = Hand-held 1 = Hands-free

INDEX

Numerics

123Scan2	13-1
2D bar codes	
aztec	15-79
aztec inverse	15-79
code 128 emulation	15-75
data matrix	15-76
data matrix inverse	15-76
maxicode	15-77
microPDF417	15-74
microQR	15-78
PDF417	15-74
QR code	15-77
QR inverse	15-78

A

AAMVA	
field parsing bar codes	17-7
accessories	1-17
lanyard	1-17
ADF	16-1
invalid rule	3-4
rules	11-6
transmit error	3-4
advanced data formatting	3-4, 11-6, 16-1
age	4-28
aiming options	
hand-held decode aiming pattern	5-35
snapshot aiming pattern	6-7
snapshot mode timeout	6-7
aiming pattern	2-6, 6-7
enabling	5-35
orientation	2-7
ASCII values	
keyboard wedge	9-13
RS-232	8-18

standard defaults	F-1
USB	7-19
attributes	
non-parameter	I-1
attributes, non-parameter	
beep on next bootup	I-4
beeper/led	I-3
configuration filename	I-2
date of first programming	I-2
date of manufacture	I-2
firmware version	I-5
host trigger session	I-4
imagekit version	I-5
in cradle detection	I-5
model number	I-1
night mode	I-2
operational mode	I-6
pager motor on scanner	I-3
parameter defaults	I-4
reboot	I-4
scankit version	I-5
serial number	I-1
authentication	4-2
auto-reconnect	4-4, 4-17, 4-22, 4-26

B

bar code defaults	
all	A-1
IBM 468X/469X	10-3
keyboard wedge	9-3
radio communication	4-2
RS-232	8-3
scanner emulation	12-3
symbolologies	15-2
USB	7-4
user preferences	5-2
wand emulation	11-3

- bar codes
 - AAMVA field parsing 17-7
 - Android HID feature 4-10
 - Apple iOS HID feature 4-10
 - Australia post 15-63
 - Australia post format 15-64
 - authentication 4-29
 - auto-reconnect in bluetooth
 - keyboard emulation (HID slave) mode 4-20
 - auto-reconnect interval 4-17
 - aztec 15-79
 - aztec inverse 15-79
 - batch mode 5-15, 5-16
 - battery reconditioning 1-15, 1-16
 - beep after good decode 5-6
 - beep on insertion 5-10
 - beeper tone 5-8
 - beeper volume 5-9, 5-10
 - bits per pixel 6-15, 6-18
 - bluetooth friendly name 4-7
 - bluetooth security 4-29
 - bookland EAN 15-9
 - bookland ISBN 15-20
 - buffering 15-32, 15-33
 - cancel D-2
 - Chinese 2 of 5 15-54
 - codabar 15-47
 - codabar CLSI editing 15-49
 - codabar lengths 15-47
 - codabar NOTIS editing 15-49
 - codabar start and stop characters 15-50
 - code 11 15-37
 - code 11 lengths 15-37
 - code 128 15-23
 - code 128 emulation 15-75
 - code 128 lengths 15-23
 - code 39 15-28
 - transmit buffer 15-34
 - code 39 check digit verification 15-31
 - code 39 full ASCII 15-32
 - code 39 lengths 15-30
 - code 39 transmit check digit 15-31
 - code 93 15-35
 - code 93 lengths 15-35
 - composite CC-A/B 15-71
 - composite CC-C 15-71
 - composite TLC-39 15-72
 - connection maintenance interval 4-26
 - continuous bar code read 5-32
 - convert case 4-16
 - convert GS1 databar to UPC/EAN 15-70
 - convert UPC-E to UPC-A 15-19
 - convert UPC-E1 to UPC-A 15-19
 - crop to address 6-8
 - data matrix 15-76
 - data matrix inverse 15-76
 - decode pager motor 5-11
 - decode pager motor duration 5-11
 - decode session timeout 5-33
 - digital imager scanner
 - default table 6-2
 - discoverable mode 4-7
 - discrete 2 of 5 15-44
 - lengths 15-46
 - driver's license date format 17-18
 - no separator 17-19
 - driver's license gender format 17-17
 - driver's license parsing 17-2, 17-3
 - send control characters 17-20
 - send keyboard characters 17-24
 - set defaults 17-17
 - set up 17-4, 17-5, 17-6
 - EAN zero extend 15-20
 - EAN-13/JAN-13 15-9
 - EAN-8/JAN-8 15-8
 - emulate keypad 4-14
 - encryption 4-31
 - flush macro buffer/abort macro
 - PDF entry 15-84
 - FN1 substitution values 5-50
 - fuzzy 1D processing 5-34
 - GS1 databar 15-67
 - GS1 databar expanded 15-68
 - GS1 databar limited 15-67
 - GS1 databar limited security level 15-69
 - GS1 databar-14 15-67
 - GS1-128 15-25
 - hand-held decode aiming pattern 5-35
 - HID caps lock override 4-13
 - HID country keyboard types 4-11
 - HID function key mapping 4-15
 - HID host parameters 4-10
 - HID ignore unknown characters 4-14
 - HID keyboard FN1 substitution 4-15
 - HID keyboard keystroke delay 4-13
 - I 2 of 5 check digit verification 15-43
 - I 2 of 5 convert to EAN-13 15-44
 - I 2 of 5 transmit check digit 15-43
 - IBM 468X/469X
 - convert unknown to code 39 10-5
 - ignore bar code configuration 10-6
 - ignore beep 10-6
 - port address 10-4
 - illumination 5-37, 6-5
 - image brightness (target white) 6-10
 - image cropping 6-7
 - image enhancement 6-12

- image file format 6-13, 6-17
- image resolution 6-9
- image rotation 6-14
- interleaved 2 of 5 15-41
 - convert to EAN-13 15-44
 - lengths 15-41
- inverse 1D 15-59
- ISBT 128 15-25
- ISBT concatenation 15-26, 15-27
- ISBT concatenation redundancy 15-27
- ISSN EAN 15-22
- Japan postal 15-62
- JPEG image options 6-10
- JPEG quality and size 6-11
- JPEG target file size 6-11
- keyboard wedge
 - alternate numeric keypad emulation 9-8
 - caps lock on 9-9
 - caps lock override 9-9
 - country keyboard types (country codes) 9-5
 - host types 9-4
 - ignore unknown characters 9-7
 - intra-keystroke delay 9-8
 - keystroke delay 9-7
- Korean 3 of 5 15-58
- lock override 4-23
- low exposure priority for snapshot mode 6-6
- low gain priority for snapshot mode 6-6
- low power mode 5-20
- matrix 2 of 5 15-55
- matrix 2 of 5 check digit 15-57
- matrix 2 of 5 lengths 15-56
- maxicode 15-77
- microPDF417 15-74
- microQR 15-78
- mobile phone/display mode 5-29
- MSI 15-51
- MSI check digit algorithm 15-54
- MSI check digits 15-53
- MSI lengths 15-51
- MSI transmit check digit 15-53
- multicode concatenation symbology 5-44
- multicode mode 5-37, 5-38
- multicode mode concatenation 5-43
- multicode troubleshooting 5-45
- Netherlands KIX code 15-65
- numeric bar codes D-2
- OCR
 - bright illumination 14-15
 - check digit 14-25
 - check digit multiplier 14-26
 - check digit validation 14-27
 - default table 14-2
 - inverse OCR 14-32
 - lines 14-12
 - maximum characters 14-13
 - MICR E13B 14-9
 - minimum character 14-12
 - OCR-A 14-3
 - OCR-A variant 14-3
 - OCR-B 14-5
 - OCR-B variant 14-6
 - orientation 14-10
 - parameters 14-3
 - quiet zone 14-14
 - security level 14-13
 - subset 14-14
 - template 14-16
 - US currency serial number 14-10
- page button 4-28
- pager motor 5-11
- pairing methods 4-24
- pairing modes 4-22
- parameter broadcast 4-22
- parameter scanning 5-6
- parser version ID 17-16
- PDF prioritization 5-31
- PDF prioritization timeout 5-31
- PDF417 15-74
- picklist modes 5-28
- postal 15-60
- prefix/suffix values 5-48
- presentation mode field of view 5-36
- presentation performance mode 5-19
- QR code 15-77
- QR inverse 15-78
- radio communication 4-5
- radio output power 4-22
- reconnect attempt beep 4-18
- reconnect attempt interval 4-19
- RS-232
 - baud rate 8-8
 - beep on 8-15
 - check receive errors 8-10
 - data bits 8-9
 - hardware handshaking 8-10, 8-11
 - host serial response time-out 8-14
 - host types 8-6, 8-7
 - ignore unknown characters 8-17
 - intercharacter delay 8-16
 - Nixdorf Beep/LED options 8-17
 - parity 8-9
 - RTS line state 8-15
 - software handshaking 8-12
- scan data options 5-49
- scanner to cradle support 4-21
- set defaults 5-5
- set pin code 4-30

- signature capture 6-16
- signature capture height 6-19
- signature capture JPEG quality 6-19
- signature capture width 6-19
- simulated caps lock 4-16
- snapshot aiming pattern 6-7
- snapshot mode timeout 6-7
- supplementals 15-10
- symbologies 15-2
- time delay to presentation
 - idle mode 5-23, 5-24
- time delay to presentation
 - sleep mode 5-25, 5-26
- timeout between decodes,
 - different symbols 5-33
- timeout between decodes,
 - same symbol 5-33
- transmit code ID character 5-47
- transmit matrix 2 of 5 check digit 15-57
- transmit no read message 5-51
- transmit UK postal check digit 15-62
- transmit US postal check digit 15-61
- trigger modes 5-17, 5-18, 5-27
- UCC coupon code 15-21
- UCC coupon extended code 15-21
- UK postal 15-61
- unique bar code reporting 5-32
- unpair 4-24
- UPC composite mode 15-72
- UPC/EAN/JAN supplemental
 - AIM ID format 15-14
- UPC/EAN/JAN supplemental
 - redundancy 15-13
- UPC-A 15-7
- UPC-A preamble 15-16
- UPC-A/E/E1 check digit 15-15, 15-16
- UPC-E 15-7
- UPC-E preamble 15-17
- UPC-E1 15-8
- UPU FICS postal 15-66
- US planet 15-60
- US postnet 15-60
- USB
 - caps lock override 7-10
 - convert case 7-15
 - country keyboard types 7-8
 - device type 7-5, 7-6
 - emulate keypad 7-12
 - function key mapping 7-14
 - keyboard FN 1 sub 7-13
 - keystroke delay 7-10
 - optional parameters 7-16
 - polling interval 7-17, 7-18
 - quick emulation 7-13
 - simulated caps lock 7-15
 - SNAPI handshaking 7-7
 - static CDC 7-14
 - unknown characters 7-11
 - USPS 4CB/One Code/Intelligent Mail 15-65
 - variable PIN code 4-30
 - wand emulation
 - code 39 full ASCII 11-6
 - convert all bar codes to code 39 11-6
 - host types 11-4
 - leading margin (quiet zone) 11-4
 - polarity 11-5
 - unknown characters 11-5
 - wi-fi friendly channel exclusion 4-8
 - wi-fi friendly mode 4-8
- batch mode stored data 5-15
- battery
 - charging 1-15
 - inserting/removing 1-11
 - reconditioning 1-16
 - reconditioning bar code 1-15
 - shutting off 1-15
- battery reconditioning bar code 1-16
- beeper definitions
 - pairing 4-3
 - standard 2-1
 - wireless 4-3
- bluetooth 1-7, 1-17
 - disconnect event 2-2, 3-5, 4-3
 - keyboard emulation 4-4
 - secure simple pairing IO capability 4-32
 - security 4-29
- bullets xxi
- C**
- cables
 - installing 1-8, 1-9
- character set 7-19, 8-18, 9-13, F-1
- charging 1-15
 - LEDs 1-15, 2-3
 - via USB 1-9
- codabar bar codes
 - CLSI editing 15-49
 - codabar 15-47
 - lengths 15-47
 - NOTIS editing 15-49
 - start and stop characters 15-50
- code 11 bar codes
 - code 11 15-37
 - lengths 15-37
- code 128 bar codes
 - code 128 15-23
 - emulation 15-75
 - GS1-128 15-25

- ISBT 128 15-25
 - ISBT concatenation 15-26, 15-27
 - ISBT concatenation redundancy 15-27
 - lengths 15-23
 - code 39 bar codes
 - buffering 15-32, 15-33
 - check digit verification 15-31
 - code 39 15-28
 - full ASCII 15-32
 - lengths 15-30
 - transmit check digit 15-31
 - code 93 bar codes
 - code 93 15-35
 - lengths 15-35
 - code ID character 5-47
 - code identifiers
 - AIM code IDs B-3
 - modifier characters B-4
 - Symbol B-1
 - communication protocol G-1
 - composite bar codes
 - composite CC-A/B 15-71
 - composite CC-C 15-71
 - composite TLC-39 15-72
 - UPC composite mode 15-72
 - configurations xix
 - conventions
 - notational xxi
 - cradle 1-7
 - connecting 1-8, 1-9
 - diagram 1-4, 1-5
 - inserting scanner 1-12
 - interfaces 1-2
 - mounting 1-10
 - parts 1-4, 1-5
 - pinouts 3-12
 - supply power 1-9, 1-10
 - cropping 6-7, 6-8
- D**
- data matrix bar codes 15-76
 - decode zone 2-8
 - default parameters
 - all A-1
 - driver's license parsing 17-2
 - IBM 468X/469X 10-3
 - imaging preferences 6-2
 - keyboard wedge 9-3
 - OCR 14-2
 - radio communication 4-2
 - RS-232 8-3
 - scanner emulation 12-3
 - symbolologies 15-2
 - USB 7-4
 - user preferences 5-2
 - wand emulation 11-3
 - digital imager scanner
 - defaults 6-2
 - discrete 2 of 5 bar codes
 - discrete 2 of 5 15-44
 - driver's license
 - ADF parsing sample 17-43
 - date format 17-18
 - no separator 17-19
 - field parsing bar codes 17-4, 17-5, 17-6
 - gender format 17-17
 - parsing bar codes 17-3
 - parsing rule example 17-39
 - driver's license parsing
 - default parameters 17-2
- E**
- encryption 4-3, 4-31
 - error indications
 - ack/nak 8-12
 - ADF 3-4
 - enq 8-12
 - format 3-7
 - input 3-5
 - miscellaneous scanner options 4-1
 - RS-232 3-5
 - RS-232 transmission 8-10
 - transmission 3-6, 8-14
 - unknown characters 7-11, 8-17, 9-7
 - xon/xoff 8-12
 - exposure options
 - gain / exposure priority for snapshot mode 6-6
 - illumination 5-37, 6-5
 - presentation mode field of view 5-36
- G**
- gain / exposure priority for snapshot mode 6-6
 - GS1 databar 15-67
- H**
- HID profile 4-6
 - HID slave 4-4
 - host types
 - IBM (port address) 10-4
 - keyboard wedge 9-4
 - RS-232 8-6, 8-7
 - scanner emulation 12-3
 - USB 7-5, 7-6
 - wand emulation 11-4

I

IBM 468X/469X connection	10-2
IBM 468X/469X defaults	10-3
IBM 468X/469X parameters	10-4
illumination	5-37, 6-5
image brightness (target white)	6-10
image cropping	6-7, 6-8
image enhancement	6-12
image options	
bits per pixel	6-15
cropping	6-7, 6-8
file formats	6-13, 6-17
image brightness (target white)	6-10
image enhancement	6-12
image resolution	6-9
image rotation	6-14
JPEG image options	6-10
JPEG size/quality	6-11
JPEG target file size	6-11
image resolution	6-9
imaging preferences parameters	6-2
inserting battery	1-11
interleaved 2 of 5 bar codes	
check digit verification	15-43
convert to EAN-13	15-44
transmit check digit	15-43

J

JPEG image options	6-10
size/quality	6-11
target file size	6-11

K

keyboard wedge connection	9-2
keyboard wedge defaults	9-3
keyboard wedge parameters	9-4
Korean 3 of 5 bar codes	15-58

L**LED**

battery reconditioning definitions	1-16
charging	1-16, 2-3
discharging	1-16
scanning	2-3
standard definitions	2-3
lock override	4-23
locked pairing mode	4-23, 4-26
low power mode	4-17

M

macro PDF	15-84
-----------	-------

flush buffer/abort PDF entry	15-84
maintenance	3-1
battery	3-4
digital scanner	3-1
master	3-5, 4-4, 4-6, 4-17, 4-22
matrix 2 of 5 bar codes	15-55
check digit	15-57
lengths	15-56
transmit check digit	15-57
maxicode bar codes	15-77
microPDF417 bar codes	15-74
mounting	
cradle	1-10
MSI bar codes	
check digit algorithm	15-54
check digits	15-53
lengths	15-51
MSI	15-51
transmit check digit	15-53
multipoint-to-point communication	4-21

N

non-parameter attributes	I-1
beep on next bootup	I-4
beeper/led	I-3
configuration filename	I-2
date of first programming	I-2
date of manufacture	I-2
firmware version	I-5
host trigger session	I-4
imagekit version	I-5
in cradle detection	I-5
model number	I-1
night mode	I-2
operational mode	I-6
pager motor on scanner	I-3
parameter defaults	I-4
reboot	I-4
scankit version	I-5
serial number	I-1
notational conventions	xxi

O

OCR	
default parameters	14-2
parameters	14-3
out of range indicator	4-20

P

pairing	
address	4-17
bar code	1-4, 2-2, 4-3

- bar code format 4-25
- beeper definitions 4-3
- charging cradle 1-7
- connection maintenance interval 4-26
- cradle host 4-4
- lock override 4-23
- lost connection to host 1-10
- master 3-5
- master/slave setup 4-6
- methods 4-24
- modes 4-2
- multipoint-to-point 4-21
- on contacts 4-2
- pin codes 4-30
- point-to-point 4-21
- radio communication 1-17
- SPP 4-4
- troubleshooting 3-6
- unpair 4-24
- parameter defaults
 - all A-1
 - driver's license parsing 17-2
 - IBM 468X/469X 10-3
 - imaging preferences 6-2
 - keyboard wedge 9-3
 - OCR 14-2
 - radio communication 4-2
 - RS-232 8-3
 - scanner emulation 12-3
 - symbolologies 15-2
 - USB 7-4
 - user preferences 5-2
 - wand emulation 11-3
- parameters
 - driver's license parsing 17-3
 - IBM 468X/469X 10-4
 - imaging 6-4
 - keyboard wedge 9-4
 - OCR 14-3
 - radio communication 4-4
 - RS-232 8-4
 - scanner emulation 12-4
 - set defaults 5-5
 - symbolologies 15-7
 - USB 7-5
 - user preferences 5-6
 - wand emulation 11-4
- parser version ID 17-16
- parsing
 - driver's license data 17-1
- parts
 - cradle 1-4, 1-5
 - scanner 1-3
- PDF417 bar codes 15-74
- PDF prioritization 5-31
- PIN code
 - static 4-30
 - variable 4-30
- pinouts
 - cradle signal descriptions 3-12
- point-to-point communication 4-21
- postal codes 15-60
 - Australia post 15-63
 - Australia post format 15-64
 - Japan postal 15-62
 - Netherlands KIX code 15-65
 - transmit UK postal check digit 15-62
 - transmit US postal check digit 15-61
 - UK postal 15-61
 - UPU FICS postal 15-66
 - US planet 15-60
 - US postnet 15-60
 - USPS 4CB/One Code/Intelligent Mail 15-65
- power 1-9, 1-10
 - via USB 1-9
- presentation mode field of view 5-36
- Q**
 - QR code bar codes 15-77
 - quiet zone (leading margin) 11-4
- R**
 - radio communication
 - bluetooth technology profile support 1-7, 1-17
 - defaults 4-2
 - host types 4-4, 4-5
 - multipoint-to-point 4-21
 - pairing 1-17
 - point-to-point 4-21
 - reconnect attempt 4-19
 - reconnect attempt beep 4-18
 - range indicator 4-20
 - reconditioning, battery bar code 1-15, 1-16
 - reconnect attempt 4-19
 - reconnect attempt beep 4-18
 - removing battery 1-11
 - replacing battery 1-11
 - RS-232 connection 8-2
 - RS-232 defaults 8-3
 - RS-232 parameters 8-4
- S**
 - sample bar codes
 - code 128 C-2
 - code 39 C-1
 - GS1 DataBar C-3

interleaved 2 of 5	C-2
UPC/EAN	C-1
scanner emulation defaults	12-3
scanner parts	1-3
scanner to cradle support	4-21
scanning	2-5
errors	5-2, 6-2, 7-11, 9-7, 15-2
radio communications	
sequence example	4-1
sequence example	5-2, 6-2, 15-1
scanning LED	2-3
secure simple pairing IO capability	4-32
serial port profile	4-6
master	4-4, 4-17, 4-22
slave	4-4
service information	xxii
setup	
connecting a USB interface	7-2
connecting an RS-232 interface	8-2
connecting keyboard wedge interface	9-2
connecting to an IBM 468X/469X host	10-2
connecting using wand emulation	11-2, 12-2
cradle	1-7
inserting scanner in cradle	1-12
installing the cable	1-8, 1-9
mounting cradle	1-10
scanner	1-7
supplying power	1-9, 1-10
unpacking	1-2
signal descriptions	3-12
signature capture	6-16
bits per pixel	6-18
file format selector	6-17
height	6-19
JPEG quality	6-19
width	6-19
slave	3-5, 4-4, 4-6
snapshot mode timeout	6-7
specifications	3-9
SPP	4-6
SPP master	4-4, 4-17, 4-22
SPP slave	4-4
stored data	
batch mode	5-15
support	xxii
symbology default parameters	15-2
symbology parameters	15-7

T

technical specifications	3-9
troubleshooting	3-4

U

unlocked pairing mode	4-23
unpacking	1-2
unpairing	
bar code	4-24
UPC/EAN bar codes	
bookland EAN	15-9
bookland ISBN	15-20
check digit	15-15, 15-16
convert UPC-E to UPC-A	15-19
convert UPC-E1 to UPC-A	15-19
EAN zero extend	15-20
EAN-13/JAN-13	15-9
EAN-8/JAN-8	15-8
ISSN EAN	15-22
supplementals	15-10
UCC coupon extended code	15-21
UPC-A	15-7
UPC-A preamble	15-16
UPC-E	15-7
UPC-E preamble	15-17
UPC-E1	15-8
USB connection	7-2
USB defaults	7-4
USB parameters	7-5
user preferences bar codes	
batch mode	5-15, 5-16
beep on insertion	5-10
set defaults	5-5
user preferences defaults	5-2

W

wand emulation connection	11-2, 12-2
wand emulation defaults	11-3
wand emulation parameters	11-4
wi-fi friendly mode	4-8
channel exclusion	4-8

Tell Us What You Think...

We'd like to know what you think about this Manual. Please take a moment to fill out this questionnaire and fax this form to: (631) 627-7184, or mail to:

Zebra Technologies Corporation
Lincolnshire, IL U.S.A.
Attention: Data Capture Solutions
Technical Publications Manager



Important If you need product support, please call the appropriate customer support number for your area. Unfortunately, we cannot provide customer support at the fax number above.

Manual Title: _____
(please include revision level)

How familiar were you with this product before using this manual?

- Very familiar Slightly familiar Not at all familiar

Did this manual meet your needs? If not, please explain.

What topics need to be added to the index, if applicable?

What topics do you feel need to be better discussed? Please be specific.

What can we do to further improve our manuals?



Zebra Technologies Corporation
Lincolnshire, IL U.S.A.
<http://www.zebra.com>

Zebra and the stylized Zebra head are trademarks of ZIH Corp., registered in many jurisdictions worldwide. All other trademarks are the property of their respective owners.

©2015 ZIH Corp and/or its affiliates. All rights reserved.



72E-131700-08 Revision A - July 2015